

This is a reproduction of a library book that was digitized by Google as part of an ongoing effort to preserve the information in books and make it universally accessible.

Google™ books

<https://books.google.com>

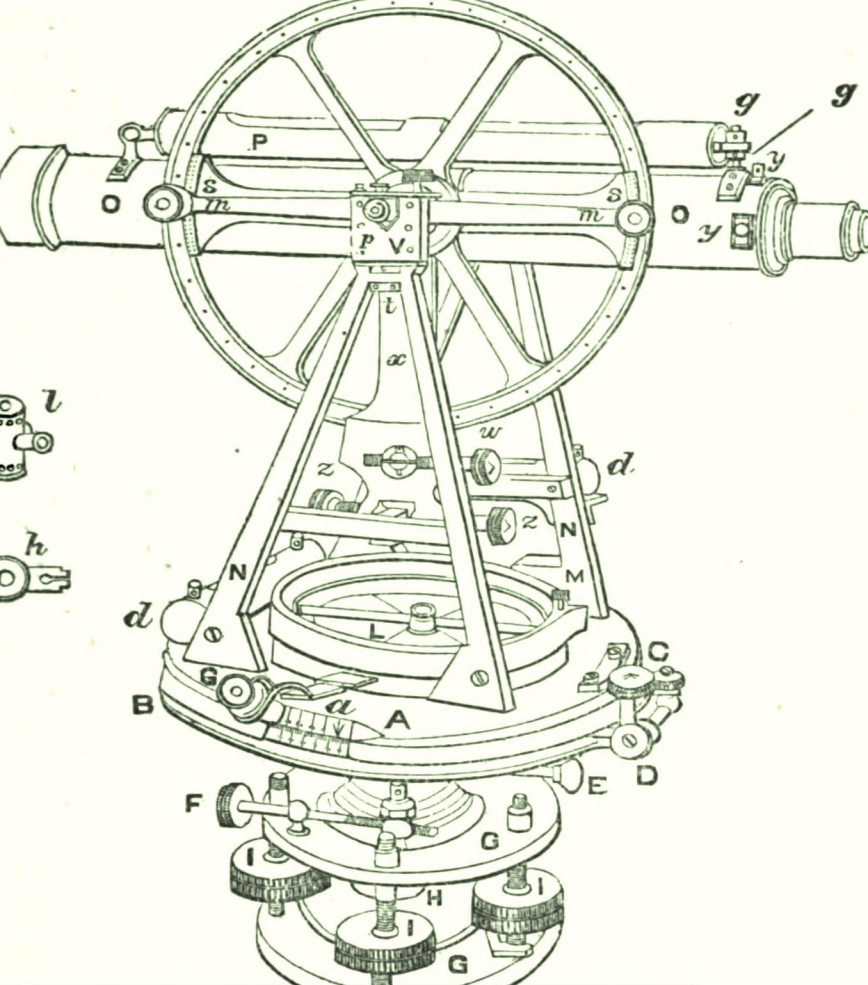



Hints to travellers

Royal geographical society

•
•
•
•
•





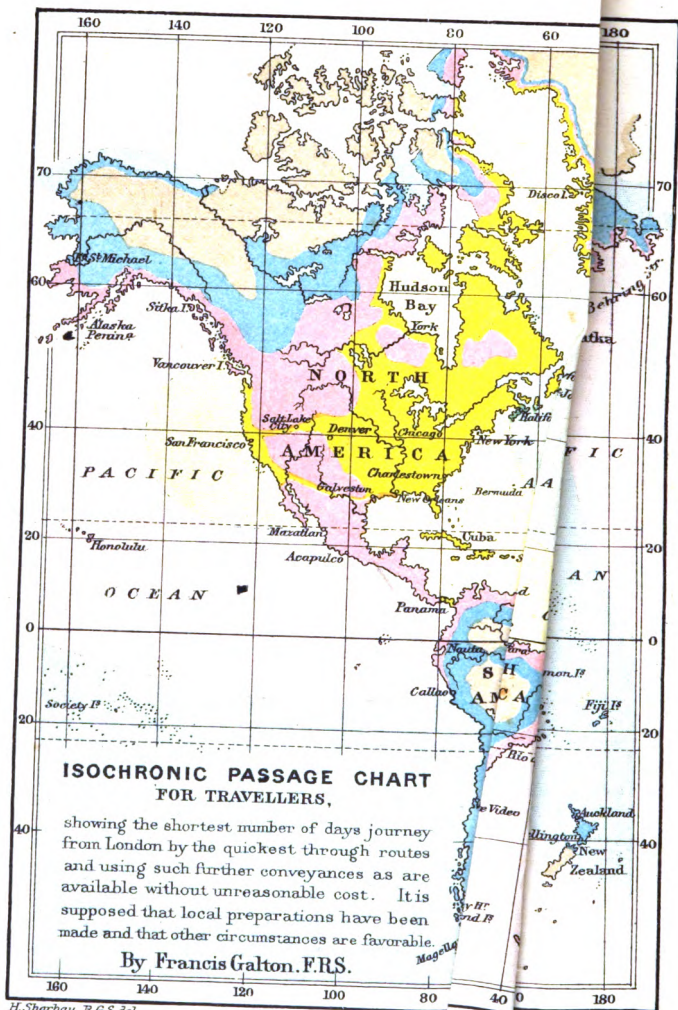

H. Sharbau. R.G.S. del.

E. Weller. lith.

Explanation of colours. Green within 10 days journey. Yellow within 20 days journey. Pink within 30 days journey. Light blue within 40 days journey.

HINTS TO TRAVELLERS

SCIENTIFIC AND GENERAL

EDITED FOR THE

Council of the Royal Geographical Society

BY

LIEUT.-COLONEL H. H. GODWIN-AUSTEN, F.R.S.

JOHN KNOX LAUGHTON, M.A.

AND

DOUGLAS W. FRESHFIELD, M.A.

FIFTH EDITION

REVISED AND ENLARGED.

LONDON:
THE ROYAL GEOGRAPHICAL SOCIETY,
1, SAVILE ROW, W.

AND

E. STANFORD, CHARING CROSS, W.

1883.

Price Five Shillings.

038 9 477

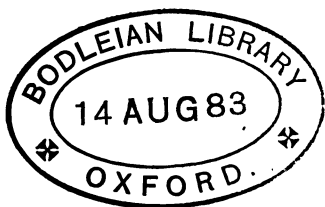

LONDON :
PRINTED BY WILLIAM CLOWES AND SONS, LIMITED,
STAMFORD STREET AND CHARING CROSS.

PREFACE.

IN issuing to the Fellows of the Royal Geographical Society and the public the fifth edition of *Hints to Travellers* it is desirable to give some account of the various changes the work has gone through before reaching its present form.

As long ago as 1854 the Council of the Society, in consequence of the frequent questions addressed to them by intending travellers, requested the late Admiral Fitzroy and Lieutenant Raper, R.N., to consider what instrumental outfit might best be recommended to explorers. Their report, together with suggestions submitted to them by Admirals Smyth and Beechey, Colonel Sykes and Mr. Francis Galton, was printed in vol. xxiv. of the Journal of the Society, and separately circulated in pamphlet form under the title of 'Hints to Travellers.'

The exhaustion of this first edition led, in 1864, to the revision and enlargement of the original work by a Committee of Council, consisting of Sir George Back, Admiral Collinson and Mr. Francis Galton. Their 'Hints' were prefaced by the remark that they were addressed to a person who, proposing to explore a wild country, asks what astronomical and other scientific outfit he ought to take with him, and what observations he may attempt with a prospect of obtaining accurate results. Hints on Photography by Dr. Pole, and on the Collection of Objects in Natural History by Mr. Bates, were added.

The success of this volume resulted in the publication, in 1871, of a third edition under the same editorship. This edition was followed in 1878 by the fourth, published under the sole editorship of Mr. F. Galton, and in a new form more convenient for pocket use. This, in its turn, has recently become exhausted.

In preparing a fifth edition the Council have been anxious to increase the usefulness of the volume, and to make it meet the in some ways higher requirements of a new generation of young travellers, many of whom receive scientific instruction in the Society's office before leaving England. To this end, Mr. F. Galton being unable again to take charge of the work, an Editorial Sub-Committee was appointed to remodel the 'Hints,' subject to the general direction and advice of a large Committee of Council.

The first object of those charged with the direction of this edition has been to furnish such help as may be possible within the compass of a convenient pocket-book to the intelligent explorer who, in the hope of obtaining from his travels valuable geographical results, has been at some pains to acquaint himself with the use of instruments. The Hints on Surveying, the principal portion of the work, have been placed in the hands of Mr. Coles, late R.N., the Society's Map-Curator and Instructor in Practical Astronomy and Surveying, who has taken great trouble both to add such new matter as his experience in teaching and travel lead him to consider requisite, and to combine and rearrange the Hints given in the earlier editions by various scientific explorers.

Many travellers, however, have not the natural disposition or the training necessary for this branch of observation. The Editors have desired therefore to direct the attention of these to the several ways in which, at a trifling expense of well-directed energy, they may add to the daily interest of their travels, and bring home results valuable to science. With this object the Hints on Collections in Natural History have been expanded, and Hints on how and what to observe in other sciences, Geology and Anthropology, have been added by Mr. W. T. Blanford and Mr. E. B. Tylor respectively. The section on Photography has been rewritten by Mr. W. F. Donkin, who has, in the High Alps, had exceptional experience in taking photographs under circumstances of great difficulty, both as to transport and exposure.

Since the success, and therefore the scientific result, of every journey

depends primarily on the health and suitable equipment of the members of the expedition, the Editors decided further to enlarge the scope of the work by supplying Hints on Medical Treatment and Precautions, and on General Outfit. The former, drawn up by Surgeon-Major Dobson, will, it is believed, be found of great value, and are recommended to the best attention of travellers.

In a work of this character numerous omissions must of necessity be discovered. In order to reduce their number and importance as far as possible, it has throughout been the aim of the Editors not only to intrust each chapter to a competent hand, but also to provide for its being read and revised before publication by high independent authorities in the same branch of knowledge. This course could not have been carried out without the cordial assent and co-operation of their responsible contributors, to whom, as well as to the many gentlemen who have given the benefit of their advice, the Council desire to return their grateful acknowledgments.

After careful consideration, it has seemed best to the Editors to supply a full Table of Contents in place of an Alphabetical Index. The arrangement of the book is such that no one who uses it seriously is likely to be at a loss where to look for the particular heading he may require.

Any corrections or additions which may suggest themselves to readers should be communicated to the Secretary of the Society, 1, Savile Row, W., for the use of the Editors of the next Edition.

H. H. GODWIN-AUSTEN.

J. K. LAUGHTON.

DOUGLAS W. FRESHFIELD.

SECTIONS AND AUTHORS.

	PAGE
I. SURVEYING, AND ASTRONOMICAL OBSERVATIONS. <i>By</i> JOHN COLES, F.R.A.S., <i>Instructor to the Royal Geographical Society</i>	1
II. METEOROLOGY. <i>By</i> R. STRACHAN, <i>of the Meteorological Office</i>	189
III. GEOLOGY. <i>By</i> W. T. BLANFORD, F.R.S.	191
IV. NATURAL HISTORY. <i>By</i> H. W. BATES, F.R.S., <i>Assistant Secretary</i> , R.G.S.	203
V. ANTHROPOLOGY. <i>By</i> E. B. TYLOR, D.C.L., F.R.S.	222
VI. PHOTOGRAPHY. <i>By</i> W. F. DONKIN, M.A., F.C.S., A.C., <i>Lecturer on Chemistry at St. George's Hospital</i>	244
VII. MEDICAL HINTS FOR TRAVELLERS. <i>By</i> G. E. DOBSON, M.A., M.B., F.R.S.	251
VIII. GENERAL HINTS ON OUTFIT, including Notes by E. WHYMPER, Colonel J. A. GRANT, C.B., and J. THOMSON	277

CONTENTS.



	PAGE
I. SURVEYING, AND ASTRONOMICAL OBSERVATIONS	1
Preliminary Remarks	
1. Scientific Outfit	1
Sextant for regular work	1
Sextant for detached expeditions, and for taking altitudes when the other sextant is in use for lunars	2
Mercurial Horizon	2
Watches	2
Compasses	3
Lantern	3
Thermometers	3
Aneroids	4
Mapping Instruments	4
Stationery	4
Books, Maps, &c.	5
Theodolites	6
Barometer	6
Telescope	6
Plane-table	7
Pedometer	7
Pocket-level	7
Maxima and Minima Thermometers	7
Rain Gauge	7
Extracts from a Letter from Sir John Kirk, M.D.	7
Examination of Instruments	8
Packing	8
2. Plane Trigonometry	9
3. Surveying with the Prismatic Compass, Boiling-point Thermometer and Aneroid	14
Observations with the Prismatic Compass	15
Boiling-point Thermometer	16
The Aneroid	18

	PAGE
Measurement of Heights with the Aneroid	18
Route Survey with Prismatic Compass, Boiling-point Thermometer, and Aneroid	19
To Plot the Bearings	20
4. Extemporary Measurements	23
To set off a Right Angle from any point on the ground by means of a Rope	25
To find the Distance of an inaccessible object with a Measuring Line	25
5. Capt. George's Mercurial Barometer	26
To fill: Spiral Cord method	26
To empty the Barometer	26
6. Description and Adjustments of six-inch Transit Theodolite	28
Adjustments	30
Parallax	30
Adjustment for Collimation	30
Adjustment of the Telescope Level	31
Adjustment of the Horizontal Limb	31
Horizontality of the Axis of the Telescope	32
The Vernier of the Vertical limb	33
7. The Sextant and its Adjustments	33
Adjustments	35
Index Error	36
To find the Index Error by a Star	36
" " " by the Sun	36
8. The Box-Sextant	38
Adjustments	38
9. The Artificial Horizon	39
10. Watches	40
11. Sextant Observations	42
To observe the Altitude of the Sun, using an Artificial Horizon	42
Observations for Latitude	43
Observations for Time	45
By sets of Altitudes	45
Equal Altitudes of the Sun, Star, or Planet	46
Equal Altitudes of a Star on the same side of the Meridian on different nights	47
To measure the Angular Distance between two terrestrial objects.	48
Table for ascertaining Heights and Distances by the Box-Sextant	50
To measure the angular distance between the Moon and Sun	51

	PAGE
To measure the angular distance between the Moon and Star or Planet	52
Observations for finding the Longitude	53
General remarks on Observing	54
12. Forms of Computation	54
Latitude by Meridian Altitude	55
Latitude by Altitudes of a Star or Planet near the Meridian.	56
Longitude by Chronometer, from Altitudes of the Sun.	58
Longitude by Chronometer, from Altitudes of a Star	60
To find the Error of a Watch by equal Altitudes of the Sun.	62
To find the Error of a Watch by equal Altitudes of a Fixed Star	64
Finding the Error of the Compass by the Sun's Azimuth	65
To find the True Bearing of a peak or any other object by means of its observed Angular Distance from the Sun	66
Clearing the Lunar Distance by Raper's Rigorous Method	68
To clear the Lunar Distance by Natural Cosines.	72
" " when the Distance is less than 90°	72
" " when the sum of Altitudes is greater than 90°	72
Graphic method of clearing a Lunar Distance by the Scale of Chords	74
To compute the Altitude of a heavenly body	74
To find Arc 1	75
To find the true Altitude	75
From the true Altitude to find the apparent Altitude	75
For the Sun or for a Planet	75
For a Star	75
For the Moon	75
Computation of Moon's true Central Altitude (Example)	76
To find the Longitude by the Moon's Altitude	78
The Observation	78
Rule—To compute Moon's Right Ascension	78
To find the G.M.T. corresponding to the computed R.A. of the Moon	79
To find the Longitude	79
Example	80
To find the Longitude by the Occultation of a Fixed Star	82
" Longitude by the Occultation of a Star (Example)	84
To find the Longitude by Eclipses of Jupiter's Satellites	86
13. To find the Latitude by observing the times when two different pairs of Stars are vertical one above the other (<i>i.e.</i> in the same Azimuth Circle)	87

	PAGE
The Observation	87
To project the problem stereographically on the Plane of the Equinoctial	87
To measure an arc of more than 90° by the Scale of Chords.	88
Preparatory problem; To describe an oblique circle which shall pass through two given points	88
Example	89
14. To find the True Meridian	90
With the Transit Theodolite	90
By the Sun, without Instruments	91
15. Method of making Route Surveys through jungle or forest, or on a steep hillside. By Lieut.-Col. R. G. Woodthorpe, R.E.	92
16. Surveys with Sextant and Prismatic Compass. By Col. Sir C. W. Wilson, K.C.M.G., R.E.	94
Projection	94
Scale	95
1. Route Survey	95
2. District Survey	98
Problem I.	98
Problem II.	99
Problem III.	99
Problem IV.	100
Problem V.	100
3. Special Survey of a small tract of country	102
4. Survey of a plot of ground containing ruins, &c.	102
Map Projections	104
Mercator's Projection	104
(A)—Table to construct Maps on Mercator's Projection	105
(B)—Given the Departure, to find the Difference of Longitude	106
Conical Projection	107
17. Remarks on the Plane Table. By Lieut.-Col. H. H. Godwin- Austen, F.R.S.	107
Saving of Labour and Time	109
On the method of training a Traveller to use the Plane Table	111
Plane Tables used in the Indian Survey Department	114
Form for Field Book	116
18. Table for rough Triangulation without the usual Instruments and without Calculation. By Francis Galton, F.R.S.	117
Examples	117
19. Measurement of the number of Cubic Feet of Water conveyed by a River in each second	119

	PAGE
Example	120
20. On Observations with Theodolites or Altazimuth Instruments. By Lieut.-Gen. J. T. Walker, C.B., F.R.S., R.E., Surveyor-General of India	121
Remarks on the manipulation of Altazimuth Instruments	126
Determinations of Time, Azimuth, Latitude and Longitude, with a Transit Theodolite	126
Latitude Observations, the time being unknown	127
" " the time being known	128
Observations for time	128
" for longitude	128
Azimuth, time and latitude being unknown.	129
Azimuths, latitude being known.	130
Azimuth, latitude and time being known	130
Azimuth, latitude and star's altitude being known	130
Formulæ and Examples	131
Latitude by Circum-meridian Observations of a Star	131
Example.—Circum-meridian Observations for Latitude to β <i>Ursæ Minoris</i> , north of the zenith	132
Longitude by Lunar Zenith distances.	132
Formulæ for the reduction of Azimuth Observations	135
21. Adjustment of the "Everest Theodolite." By Capt. Pratt, R.E.	136
1. Correction for Parallax	136
2. Making the Level of the Horizontal Limb parallel to that Limb	136
3. Levelling the Instrument, <i>i.e.</i> making its Vertical Axis truly vertical	136
4. Collimation	137
(a) Vertical Collimation	137
(b) Horizontal Collimation	137
22. Tables	137
Explanation of the Tables	137
Table I.—Declination of the Sun at Mean Noon	1883 and 1887 . 143
at Greenwich for the Years	1884 and 1888 . 144
	1885 and 1889 . 145
	1886 and 1900 . 146
" II.—Equation of Time for Apparent Noon	1883 . 147
at Greenwich for the Years	1884 . 148
	1885 . 149
	1886 . 150

	PAGE
Table III.—Sun's Mean Right Ascension	151
„ IV.—Mean Places of 44 of the principal Fixed Stars for January 1st, 1883	152
„ V.—Approximate Times of the Meridian Passages (<i>in apparent time</i>) of 44 Stars of the 1st and 2nd magnitudes, on the first day of each month	153
„ VI.—Correction for the day of the month to be <i>subtracted</i> from the apparent time of a Star's Meridian Passage on the first day of the month	154
„ VII.—Corrections for Refraction	155
„ VIII.—Semi-diurnal and Semi-nocturnal Arches, showing the time of the Rising and Setting of the Sun, Moon, or Equatorial Stars	156
„ IX.—Distance of the Sea Horizon uncorrected for effects of Refraction	158
„ X.—Values of $\frac{2 \sin^2 \frac{1}{2}\text{-hour } \angle}{\sin 1''}$	159
„ XI.—Number of Geographical Miles, or Minutes of the Equator, contained in a Degree of Longitude under each Parallel of Latitude, on the supposition of the Earth's spheroidal shape with a compression of $\frac{1}{317}$	161
„ XII.—Table for converting Statute into Geographical Miles	162
„ XIII.—For converting Geographical into Statute Miles	163
„ XIV.—Comparison of Thermometer Scales	164
„ XV.—For converting English Inches and Tenths into Milli- meters	165
„ XVI.—Natural Cosines	166–180
23. Tables for the Determination of Heights. By Francis Galton, M.A., F.R.S.	181
By the Temperature of Boiling Water, &c.	181
Table I	182–184
„ II.—Correction for Temperature of Intermediate Air	184
By Barometer or Aneroid	185.
Method of Computation	185
Tables, Part I. Argument, the observed Height of the Baro- meter at either Station	187
„ „ II. Correction due to T—T', or the difference of the (not for that of the intermediate air) temperatures of the Barometers themselves, at the two stations.	188

	PAGE
Tables, Part III. Correction due to the Change of Gravity from the Latitude of 45° to the Latitude of the place of Observation	188
" " IV. Correction for Decrease of Gravity on a Vertical	188
" " V. Correction due to the Height of the Lower Station	188
II. METEOROLOGY	189
III. GEOLOGY	191
Outfit	192
Collections	193
Method of Observation	196
Investigation of Mountain-Chains	198
" " Volcanoes and Volcanic Rocks.	198
" " Coasts	198
" " Rivers and River-plains	199
" " Lakes	200
" " Evidence of Glacial Action	200
" " Deserts	202
" " Early History of Man in Tropical Climates	202
IV. NATURAL HISTORY	203
Outfit	203
Where and what to Collect	205
Mammals and Birds	207
Preserving Mammals, &c., in Alcohol. By Dr. G. E. Dobson	209
Preparation of Skeletons of Animals. By Prof. W. H. Flower, F.R.S.	211
Reptiles and Fishes. By Mr. Osbert Salvin	212
Land and Freshwater Mollusca. By Lt.-Col. H. H. Godwin-Austen	214
Insects	216
Botanical Collecting. By J. Ball, F.R.S.	217
1. Selection of Specimens	217
2. Conveyance of Specimens to Camp or Station	217
3. The Drying Press	218
Fossils	220
Observations of Habits, &c.	220
V. ANTHROPOLOGY	222
Physical Characters	222
Language	226
Arts and Sciences	229

	PAGE
Society	234
Religion and Mythology	239
Customs	242
VI. PHOTOGRAPHY	244
Necessary apparatus	244
Camera	244
Slides for holding the sensitive plates	245
Focussing cloth	245
Camera-stand	245
Small pocket-level	245
Lenses.	245
Sensitive plates	246
Lantern	247
Apparatus and Chemicals for development	247
Preliminary practice	248
Operations necessary for taking a picture.	248
Expense and packing	250
VII. MEDICAL HINTS FOR TRAVELLERS	251
1. Personal Care of Health	251
Protection of the Body	251
" " Head and Spine	252
Avoidance of draughts and damp clothes	253
Malarious regions, use of mosquito curtains in	253
" " early rising fatal in	254
Excesses in bathing.	254
" " eating and drinking	255
2. Recognition and Treatment of Disease	257
A. Medical Diseases	257
Sea-sickness	257
Colds, Coughs, Pleurisy, Pneumonia, Rheumatism	258
Constipation	259
Colic, Diarrhoea, Dysentery	260
Fevers (malarious and continued)	261
Liver Congestion and Abscess	262
Night and Snow Blindness	263
Ophthalmia and Iritis	264
Piles, Prickly-heat, and Ringworm	265
Sleeplessness	266

CONTENTS.

XV

	PAGE
Sunstroke	266
Internal Parasites	267
B. Surgical Diseases	267
Hæmorrhage	267
Blisters on Feet	267
Boils and Carbuncles	268
Bruises	268
Chilblains and Frostbites	268
Concussion of the Brain	269
Fractures and Dislocations	269
Rupture.	271
Poisoned Bites	271
Sprains	273
Ulcers	273
Wounds.	273
Transport for the Sick	274
Contents of Traveller's Medicine Box	274
VIII. GENERAL HINTS ON OUTFIT	277
General Remarks and References	277
Methodical Arrangement	278
Security against breakage, damp, robbery	278-9
Economy	279
Catalogue of Outfit	279
Provisions	280
Clothing	280
Instruments	280
Stationery, Books, and Maps	280
Appliances for Collecting	281
Presents and Articles for Barter	281
Camp Equipments and Miscellaneous	281
Travellers' Filter	281
Arms and Ammunition	282
Medicines	282
Requisites for a Tropical Tour	283
Requisites for an Arctic Tour	284
List of Mr. Whympers's South American Outfit.	284
List of the Late Captain Speke's Outfit	289
Mr. J. Thomson's Notes.	293
Mountain Travel. By Douglas W. Freshfield	295

HINTS TO TRAVELLERS.

I.

SURVEYING, AND ASTRONOMICAL OBSERVATIONS.

By JOHN COLES, F.R.A.S., *Instructor to the Royal Geographical Society.**

Preliminary Remarks:—The intending traveller who proposes to undertake even the roughest survey of an unexplored country, should make himself acquainted with the use and adjustments of every instrument he purposes to employ; he should have a knowledge of plane trigonometry, and those computations of practical astronomy which are necessary to enable him to fix his position in latitude and longitude. Without such previous training it is scarcely possible for him to map the country through which he travels, nor will he be able to take advantage of these 'Hints,' as the matters dealt with will be beyond his comprehension. The attainment of this necessary amount of knowledge is by no means difficult, and a few weeks of study, under proper instruction, ought, in most cases, to enable him, by the aid of the following hints, to do useful geographical work. It is with this end in view that the early portion of this section of 'Hints to Travellers' has been written in the simplest form, in the hope that it may serve as an introduction to, without at all superseding, the necessary text-books on nautical astronomy.

1. SCIENTIFIC OUTFIT.

Sextant for regular work—

A sextant of 6-inch radius, light in weight, by a first-rate maker, divided on platinum, to ten minutes, to read to ten seconds. It

* To the sections which have been supplied by other writers, the author's name is in each case appended.

should have a movable ground-glass screen in front of the reading-off lens, to tone down a glaring light.

The handle must be large and convenient; the box capacious enough to hold the instrument with its index clamped to any part of the arc, and the receptacle for the inverting telescope long enough to allow of it being put into the box when set at focus.

Sextant for detached expeditions, and for taking altitudes when the other sextant is in use for lunars—

A sextant of 3-inch radius, graduated to 20' to read to 20', in a leather case, fitted to slip on to a leather belt, to be worn round the waist, when required.

Mercurial Horizon—

One of the common form by a good maker, will suffice, or the form devised by Captain George, R.N., may be preferred. *See* p. 39. *Reserve*: an iron 3- or 4-ounce bottle of pure mercury.

Watches—

A keyless silver half-chronometer watch, not too heavy, with an open face and a second hand. The hands should be of black steel, long enough to cover the divisions. The divisions should be very clear and distinct. See that the second hand falls everywhere truly upon the divisions. *Reserve*: at least two more good watches; these should be rolled up separately, each in a loosely-wrapped parcel of *dry* clothes, and they will never come to harm; they should be labelled, and rarely opened. The immediate envelope should be free from fluff or dirt. Covers of chamois leather should be washed before use. Half-a-dozen spare watch-glasses, fitting easily—two to each watch (learn from a watchmaker how to put them in). Three spare watch-keys; one might be tied to the sextant-case, one wrapped up with each watch. (*See* p. 40 for further particulars.)

Mem.:—Chronometers are designedly omitted from this list, on account of the proved difficulty of transporting them without injury, and the frequent disappointments they have caused, even to very careful travellers.

Compasses—

A prismatic compass, graduated on silver or aluminium, from 0° to 360° .

Two pocket compasses, from $1\frac{1}{4}$ to 2 inches in diameter. The graduations on their cards should run from 0° to 360° , and not twice over from 0° to 180° . A line for True North, temporarily marked on the cards, in the position most appropriate to the magnetic variation in the country about to be visited, may be found convenient. These compasses should be light in weight, have plenty of depth, and be furnished with catches, to relieve the needle from its pivot when not used. The needles should work steadily and quickly: such as make long, slow oscillations are to be avoided. Cards, half black and half white, are recommended. (See p. 15 for further particulars.)

Lantern—

To be used with oil, and furnished with a large wick. See that there is abundant supply of air from air-holes in the *sides*; these are essential when the lantern is set upon the ground. Also that all the internal fittings can be removed and cleaned, and that they are solidly made, not merely soldered. It should be furnished with a reflector, to throw a clear light forwards and *downwards*. A movable shade of light green glass will be found to be a great improvement, as it prevents the light from dazzling the eyes, and enables the observer to take the reading on the sextant with greater ease. A good lantern is *most important*. A small ball of spare wick, oil of the best quality, and wax tapers, for use on detached expeditions, should also be taken.

Thermometers—

Three short and stout boiling-point thermometers, with apparatus for boiling them, and the readings of all three, taken at every station of observation. (See p. 17 for further particulars.)

Three ordinary thermometers, which should be graduated from 10° or more below the freezing- to above the boiling-point.

Standard thermometers, at a charge of *l.* each, graduated at the Kew Observatory, may be obtained thence, on the application

of any Fellow of the Royal Society, or Member of the British Association.

Aneroids—

Large pocket size ($2\frac{1}{2}$ inches across), capable of working without fracture over the highest mountain pass that is expected. They can be obtained graduated up to 15,000 feet at most instrument makers. At any such height, however, their records are not to be depended on. Aneroids are excellent for most differential observations, but *unreliable for absolute* ones: they should be observed, as much as possible, in conjunction with the boiling-point thermometers. Two are required, because simultaneous observations are important. Recollect that such observations, taken even at distances of two or three hundred miles apart, are of value; as the areas are usually very large over which the barometer has nearly the same height at the same moment of time. For Barometers, see "*Additional Instruments.*"

Mapping Instruments—

A small case of drawing instruments, containing, among other things, hair-compasses, beam-compasses, drawing-pen, and a rectangular protractor, with scales of chords, sines, tangents, &c., engraved on it.

Marquois's scales, for ruling parallel lines at definite intervals.

Protractors: one circular, of metal, of 5 or 6 inches in diameter; one of horn, 5 inches, all graduated, like your compasses, from 0° to 360° .

A graduated ruler of 1 foot or more, in metal; 2 dozen artist's pins.

Medium size measuring tape, say 12 yards; pocket ditto, 2 yards.

Stationery—

An artist's board, not less than 8 inches by 13, made of light, well-seasoned mahogany and what cabinet-makers call "framed," to rule and draw upon.

Plenty of good ordinary paper. Reporters' note-books, ruled (not "metallic," for prepared paper wants strength, and the leaves of

such books are very liable to become torn out and lost; they are also damaged by wet). They should be all of one size, say 7 inches by 4½, or larger, and numbered. A leather pouch, secured to the waist-belt, having a flap buttoning easily over, to hold the note-book in use.

Two (or more) MS. books of strong ruled paper, foolscap size, each with a leather binding; the pages should be numbered, and journal observations, agreements, and everything else of value, written in them.

Some sheets of blotting-paper cut up and put here and there in the ledgers.

Transparent cloth for tracing.

Plenty of brass pens and holders; also fine drawing-pens (steel crow-quills—Brandauer's Oriental pens are very good) and holder. FH pencils; HB ditto.

Penknives. India-rubber cut up in bits.

Ink-powders of a kind that do not require vinegar. Red ink.

Paints for maps, viz., Indian ink, sepia, lake, cobalt, gamboge, oxgall, in a small tin case.

A dozen sable paint-brushes.

Materials for "squeezes," if travelling where inscriptions may have to be copied.

Books, Maps, &c.—

Raper's Practice of Navigation (Potter, 31, Poultry, London); or, in default of these, either Inman's (Navigation and Tables bound together), or Norie's Navigation.

Weale's Tables are convenient from their compactness.

Shadwell's Cards of Formulæ (Potter, 31, Poultry, London);
Bethune's Tables for Travellers (Blackwood and Sons).

With the help of either of these little publications, the traveller, who has any knowledge of mathematics, will thoroughly understand what he is about, and may, on emergency, dispense with the usual cumbrous navigation tables, confining himself to ordinary tables of logarithms. But we have recommended that all travellers should be furnished with those navigation tables, because they

*

afford at a single reference what otherwise requires additional trouble to obtain.

'Nautical Almanac' for current and future years, strongly stitched in cloth.

Some small Almanacs, such as Whitaker's, contain tables of the position of sun and planets, and of stars to be occulted. One of these is useful to afford what is necessary to take on a detached expedition, the required pages being cut out of it.

More extended barometric tables than are given in this volume may be procured at the instrument-maker's, or cut out from Guyot's elaborate Meteorological tables, published by the Smithsonian Institution, New York.

Celestial Maps pasted on calico, and learn how to use them.

Blank maps, ruled for the latitudes and longitudes of the proposed route.

The best maps obtainable of the country you propose to visit.

Admiralty Manual for the use of Travellers.

Mem.—Chauvenet's Astronomy (New York, 2 vols.) is one of the most complete and thorough of the mathematical works on astronomical observations: it is, however, a book for previous study, rather than for reference in the field.

Additional Instruments, not necessary, but convenient.

Theodolites. (See pp. 28 and 121.)

Barometer—(See p. 26).

Barometers of Fortin's pattern were successfully carried to great heights by Mr. Whympers, in South America; but the risk of breakage, at all times very great, is proportionally greater on longer journeys. Captain George's barometers, which are carried with empty tubes and filled when required, are much more portable than mercurial barometers of any other form; but the filling them is a work of time and delicacy, which may be difficult or even impossible on a mountain top with an icy wind blowing.

Telescope for observation of eclipses of Jupiter's satellites (see pp. 83 and 86).

One of 2 inches object glass (clear aperture), and of 40 magnifying power, by a really first-rate maker, and well mounted on a stand

that can be screwed firmly to a tree or other temporary support will be sufficient; but a larger telescope, more substantially mounted, is better. In any case, the telescope should be tried on Jupiter, and found to give a satisfactory view of the satellites, before it is taken.

Plane table.—For information as to its use and the best form of construction, see Lt.-Col. Godwin Austen's remarks (p. 107).

Pedometer.—Apt to get out of order. If employed, at least three persons should each carry one.

Pocket level (Abney's), with a mirror to show where the bubble is, when it is held to the eye. It also serves as a clinometer for the measurement of slopes.

Maxima and minima thermometers.

Rain gauge.

Extracts from a Letter from Sir JOHN KIRK, M.D., K.C.M.G., &c.

“When Dr. Livingstone and I crossed the mountains and reached Lake Shirwa, our outfit was as follows: one 6-inch sextant, one mercurial horizon, one pocket chronometer, two prismatic compasses, one pocket compass, one field-glass, one aneroid barometer, two common thermometers, two boiling-point thermometers (the brass apparatus commonly supplied is quite superfluous), botanical paper, arsenical soap, one wide-mouthed bottle containing spirits of wine, pocket-lens, knives, note-books, water-colours, mathematical tables, nautical almanac, and wax candles.

“The sextant and horizon were under the care of one man. They are on no account to be contained in the same box, partly from the danger of escape of mercury, but more especially to avoid the severe shock which so heavy a weight receives when placed on the ground, or should it happen to strike against a rock or tree; and these are contingencies to be expected. When carried, the limb should be very lightly clamped on the arc. We found no better plan when on the march, than having the sextant and horizon fastened to opposite ends of a bamboo or stick, and carried over the shoulders of one of the porters. All the other instruments not carried by ourselves were packed among the other baggage. We read off the sextant by the help of the wax candles, which, from the stillness of the nights, we were able to use in the open air. On a short journey such an outfit is all that can be desired.”

Examination of Instruments.

Let every Instrument be tested, and its errors determined and tabulated at the Kew Observatory. This is done for a trifling fee. The following are some of the present charges:—Ordinary thermometers, 1s.; boiling-point thermometers, 2s. 6d.; marine and portable barometers, 10s.; prismatic compasses, 2s. 6d.; superior sextants, 5s. Unifilers, dip circles, and other magnetic instruments are also verified. The carriage of the instruments to and from the Observatory must be paid. Address—“Superintendent of the Kew Observatory, Richmond, Surrey.” The establishment lies ten minutes’ walk from the Richmond railway station. Any persons ordering instruments from opticians may direct them to be previously forwarded to Kew for verification, either to the above address, or through the receiving establishment at the Meteorological Office, 116, Victoria Street, Westminster, S.W.

Packing.

It is difficult to give general rules, because the modes of transport vary materially in different countries. Inquiry should be made by the intending traveller at the Royal Geographical Society’s rooms as to the kind of packing best suited for his special purposes and field of exploration. The corners of all the instrument cases should be brass-bound; the fittings should be screwed, and not glued; and the boxes should be large enough to admit of the instruments being taken out and replaced with perfect ease. Instrument-makers are apt to attend over-much to compactness, making as much as possible go into a small solid box, which can easily be put on a shelf; but this is not what a traveller wants, bulk being rarely so great a difficulty to him as weight. Above all, it is most important that he should be able to get at his instruments easily, even in the dark. He should notice particularly the manner in which the instrument is placed in its box, before taking it out, and in the case of a theodolite, observe the positions of the verniers and the object end of the telescope, attention to this will prevent much loss of time and possible injury to the instrument. Moreover, a large light box suffers much less from an accidental concussion than a small and heavy one. Thermometers travel best when slipped into india-rubber tubes. A coil of such tubing will serve as a floor, to protect a case of delicate instruments from the effects of a jar. Horse-hair is of use to replace old packing, but it has first to be prepared by steeping in boiling water

twisting into a rope, and, after it is firmly set, chopping it into short pieces. The hairs retain their curvature and act as springs. Instruments travel excellently when packed in *loose, tumbled* cloths.

2. PLANE TRIGONOMETRY.

The following formulæ are of frequent use in all surveying problems. In right-angled triangles, B being the right angle, if either A or C is known, the other is found by subtracting the known angle from 90°. For the rest we have :—

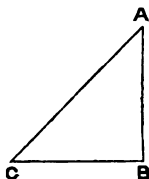

TABLE I.

Case.	Given.	Required.	Solution.
1	Hyp. AC Angles ..	Base CB. Perp. AB	$CB = AC \times \cos C.$ $AB = AC \times \sin C.$
2 & 3	Base CB Angles ..	Perp. AB Hyp. AC	$AB = CB \times \tan C.$ $AC = CB \times \sec C.$
4 & 5	Hyp. AC Perp. AB	Angles .. Base BC	$\sin C = AB \div AC; \cos A = AB \div AC.$ $BC = \sqrt{(AC + AB) \times (AC - AB)}.$
6	Perp. AB Base BC	Angles .. Hyp. AC	$\tan C = AB \div BC; \cot A = AB \div BC.$ $AC = BC \times \sec C.$

In oblique-angled triangles, if two of the angles are known, the third angle is found by subtracting the sum of the two from 180°; for the rest we have :—

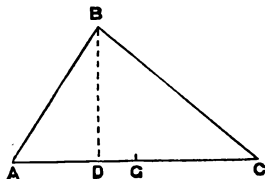

TABLE II.

Case.	Given.	Required.	Solution.
1	The angles and side A B.	Side B C Side A C	$B C = A B \times \sin A \times \operatorname{cosec} C.$ $A C = A B \times \sin B \times \operatorname{cosec} C.$
2 & 3	Two sides A B, B C, and angle C opposite to one of them.	Angle A. Angle B. Side A C	$\sin A = \sin C \times \frac{B C}{A B} \div A B.$ $B = 180^\circ - (A + C).$ $A C = A B \times \sin B \times \operatorname{cosec} C.$
4 & 5	Two sides A B, A C, and the included Angle A.	Angles C and B Side B C	$\tan \frac{B - C}{2} = (A C - A B) \times \cot \frac{A}{2} \div (A C \times A B).$ and, $\frac{B + C}{2} = 90^\circ - \frac{A}{2}$: from which $B = \frac{B + C}{2} + \frac{B - C}{2}$: and $C = \frac{B + C}{2} - \frac{B - C}{2}$. $B C = A B \times \sin A \times \operatorname{cosec} C.$
6	All three sides.	All the Angles	From half the sum of the three sides, subtract, separately, each of the three sides. Multiply these four numbers (the half sum and the three remainders) together, and take twice the square root of the product. This result, divided by the product of any two of the sides, gives the sine of the angle between them.

The foregoing equations may be solved by multiplication and division, with the table of natural sines, cosines, &c.; but in order to avoid such a tedious process, logarithms are usually employed. In calculating with logarithms, remember that multiplication is performed by adding together the logarithms of the numbers to be multiplied: the sum is the logarithm of the product: division is performed by subtracting the logarithm of the divisor from the logarithm of the dividend; the remainder is the logarithm of the quotient. Remember also that *twice* the logarithm of a number is the logarithm of its square; and that *half* its logarithm is the logarithm of its square root.

The following are some of the most useful examples of the practical application of the rules given in Tables I. and II. The angles may be measured with a sextant.

(1.) Wishing to ascertain the height of a point C (Fig. 1), which could not be approached nearer than B, I observed the angle of altitude $CBD = 34^\circ$, and measured the distance from B to A = 200 feet, at which place I found the angle $CAB = 19^\circ 30'$.

FIG. 1.

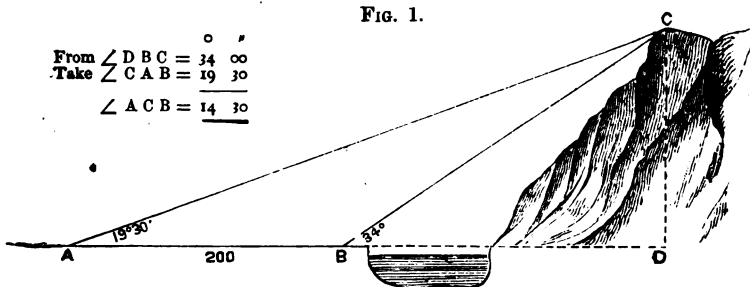

Having found the $\angle ACB$ as above, I then computed the length of BC by *Case 1, Table II*. Then as the $\angle CDB = 90^{\circ}$, I computed the height CD by *Case 1, Table I*.

(2.) To measure the breadth of a river when standing at B (Fig. 2), a short distance from it, I sent on a man with a staff to a distance which I judged to be greater than the breadth of the river; I then motioned him to the right and left until he was in such a position that the reflected image of the staff was shown exactly over a tree on the opposite bank (as seen directly), when I had 90° on the arc of my sextant; having set my sextant to 45° , I walked in a straight line towards the staff until I reached a position, A , where, on looking through my sextant, I saw the reflected image of the tree shown exactly over a mark set up at B (as seen directly). I then measured the distance from A to B , which I found to be 220 feet; from this I subtracted 30 feet, the distance of B from the water, and this gave me the breadth of the river, 190 feet.

FIG. 2.

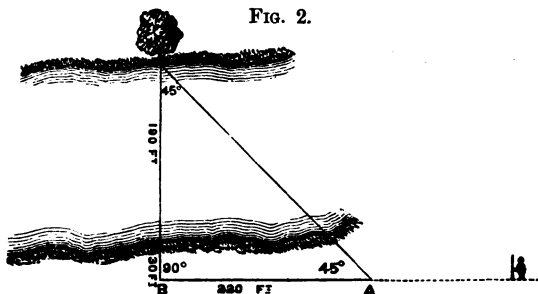

(3.) In order to measure the breadth of a river I set up a mark, A, (Fig. 3) close to the water, from this point I measured a base of 200 yards, parallel to the course of the river, and set up another mark, B. The angles, subtended by a rock on the opposite bank and each end of the base were, A 75° , B 40° . I then computed the breadth of the river by *Case 1, Table II.*

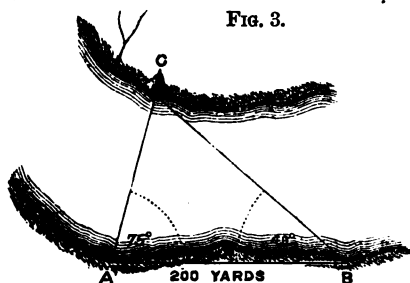

$\angle A$	75	0
$\angle B$	40	180
	<hr/>	115
	115	$\angle C = 65$

(4.) To ascertain the height of an inaccessible peak, A (Fig. 4), above my position C, I measured its angle of elevation with a theodolite, and

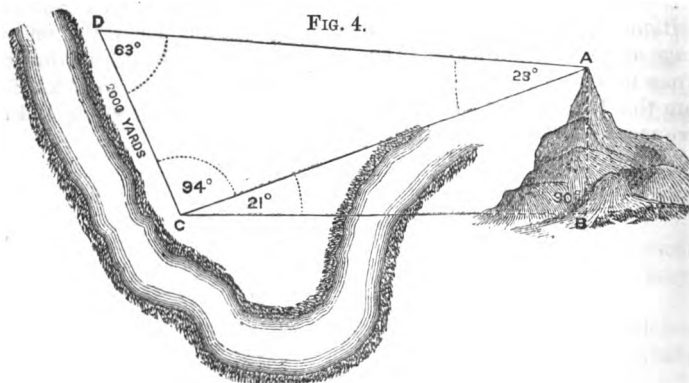

found it to be 21° ; as a river behind me prevented my taking a base in that direction, I measured one of 2000 yards to the left of C and set up a

mark D. The angles subtended by the peak, A, at each end of the base, were found to be, C 94° , D 63° ; with these angles and the base CD, I computed the side AC by *Case 1, Table II*. Then as AC is the hypotenuse of the right-angled triangle ABC, I computed the height of the peak by *Case 1, Table I*.

FIG. 5.

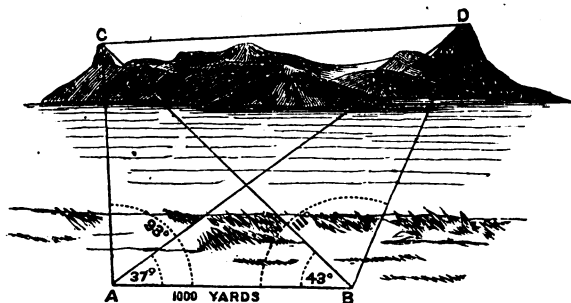

(5.) The distance between two inaccessible peaks, C and D, (Fig. 5) being required, I measured a base, A B, of 1000 yards, setting up a mark at each end. I then measured the angles between the two peaks, at both ends of the base, and found them to be:—at A, 37° and 93° ; at B, 43° and 111° . In the triangle ABC, by subtracting the sum of angles A and B, = 136° , from 180° , I found the angle C to be 44° ; by a similar process I found the angle D in the triangle ABD to be 32° , and in the triangle BCD, by subtracting 43° , the smaller angle, from 111° , the greater, I found the angle at B = 68° . Having thus found all the necessary data, in the triangle ABC, I computed the side CB (*Case 1, Table II*), and in the triangle ABD, I computed the side DB (*Case 1, Table II*). With the sides CB and BD, of the triangle BCD and the included angle B, I computed the side DC (the distance between the inaccessible peaks) by *Cases 4 and 5, Table II*.

3. SURVEYING WITH THE PRISMATIC COMPASS, BOILING-POINT THERMOMETER, AND ANEROID.

This is the most simple, but, at the same time, the least accurate, mode of surveying. The compass is used to measure the horizontal angles, the aneroid and boiling-point thermometer to find the elevations above sea-level, or any other station where simultaneous readings have been taken. The following is a description of these instruments.

Prismatic Compass.

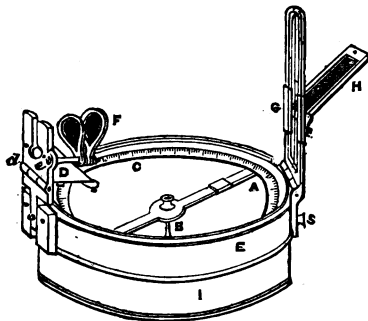

This instrument consists of a magnetic needle, A, balanced on a pivot, B, carrying an aluminium ring, C, divided into 360°; it is graduated from the south pole of the needle,—by west, north, and east to south again, from 0° to 360°, the 0° is not shown on the ring since it coincides with 360°. A prism, D, is fixed on one side of the box, E, mounted on a hinge-joint, *d*; it can be turned down when not in use, and is attached to a plate, *e*, which slides up and down to suit the vision of the observer. In the plate there is a slit through which the observer looks; it has also an arm with two dark glasses, F, to protect the eye when taking a bearing of the sun. On the opposite side of the box is a sight-vane, G, having a fine thread down its centre, and a mirror, H, which slides on and off as required; it can be used with its face up or down, so as to reflect images of objects which cannot be directly observed. The sight-vane is also

fitted with a hinge-joint, and when shut down presses on a lever, which lifts the needle off the pivot. In front of the sight-vane there is a small stud, *s*, by pressing which with the finger the ring is brought to rest; it also serves to check the vibration of the needle. The box, *E*, has a cover, *I*, which fits either the top or bottom, in which latter position it is shown in the drawing, and serves to hold the instrument when taking an observation. Some prismatic compasses have a green card in the place of a graduated aluminium ring: when this is the case, the *south* pole of the magnetic needle is placed under the 360° of the card, and this of course renders such a compass unfit for taking bearings except through the prism; it will therefore be convenient, for taking rough bearings, for the traveller to provide himself with a pocket compass having a card of the size and pattern shown below; it should be made of aluminium, which is both light and strong. The compass box should be fitted with a lever to throw the magnetic needle off its centre when the compass is not in use, and the glass should be thick, flat crystal.



Observations with the Prismatic Compass:—To take an observation with the prismatic compass, first adjust the prism by sliding it up and down until the divisions on the circle are seen distinctly; if a tripod stand is used, screw the compass to the ball-and-socket joint, and

move the instrument until it is perfectly horizontal (the same precaution must be taken if it is held in the hand); raise the sight-vane until it is perpendicular; look through the slit in the prism-plate, and bring the thread of the sight-vane in a line with the object; wait until the magnetic needle comes to rest, and read the bearing through the eye-hole in the prism-plate. A bearing thus taken shows the angle which a straight line drawn from the observer, to the object, makes with the magnetic meridian (called the magnetic bearing). To get the true bearing the magnetic variation must be applied as follows:— If the variation is east add it to the bearing, if west subtract it, and the result in both cases will be the true bearing. Thus: the magnetic bearing of an object was 160° and the variation 20° east, then $160^{\circ} + 20^{\circ} = 180^{\circ}$, the true bearing: the bearing of an object was 160° and the variation 20° west, then $160^{\circ} - 20^{\circ} = 140^{\circ}$, the true bearing; but since the magnetic needle will be affected equally by variation, within certain limits of time and space, the difference of the bearing of any two objects, taken from the same station, will be the *angle* subtended by them, as the *difference* in their azimuths will not be affected by the variation. Where possible, the bearings should be taken at both ends of a base, or line of bearing, and the mean should be taken as the correct bearing. When the sun's azimuth or amplitude has to be taken, one of the dark glasses should be placed before the slit in the prism-plate, and the mirror should be moved on the sight-vane until the reflected image of the sun is seen in the mirror through the slit in the prism-plate; the bearing is then taken in the manner before described. Great care must be observed when using this instrument to avoid all magnetic rocks, as they may so affect it as to render all bearings taken in their vicinity useless.

Boiling-point Thermometer.

The boiling-point apparatus consists of a thermometer, A, graduated from 180° – 215° , a spirit lamp, B, which fits into the bottom of a brass tube, C, that supports the boiler, D, and a telescopic tube, E, which fits tightly on to the top of the boiler. The thermometer is passed down the tube, E, from the top until within a short distance from the water, *which it should never touch*, and is supported in that position by an india-rubber washer, F. The steam passes from the boiler up the tube, E, and escapes by the hole, G. To pack this instrument for travelling, withdraw the

thermometer, and put it into a brass tube, lined with india-rubber, having a pad of cotton-wool at each end; take off the tube, E, shut it up and put the small end into the boiler, D, which it fits, then withdraw the spirit lamp, B, screw the cover over the wick and replace it in C. The whole of this apparatus fits into a circular tin case, 6 inches long and 2 inches in diameter.

To use the boiling-point thermometer:—Take the apparatus to pieces, pour some water into the boiler, D, the less the better, as it will boil quicker, about one quarter full is quite sufficient; then put the instrument together as shown in the drawing, taking care that the thermometer is at least half an inch clear of the water, and light the spirit lamp: as soon as the water boils, the steam, ascending through the tube, E, will cause the mercury to rise; wait until the mercury becomes stationary, and then read the thermometer; at the same time, take the temperature of the air in the shade with an ordinary thermometer.

When purchasing this apparatus be careful to see that the lamp is large enough to hold a good supply of spirit; it is a common fault to make it too small. A small screen, which may be made of tin to fold up, is most useful to place on the windward side, and at a very low temperature is almost indispensable, as the heat is otherwise carried off too rapidly for the water to boil properly.

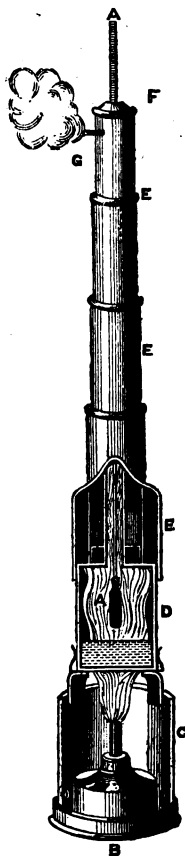

The Aneroid.

The general appearance of the aneroid is so well known that it requires no special description: it is an excellent instrument for laying down contour lines; but for absolute heights it should be checked by the boiling-point thermometer, because its index error is apt to change: when thus checked it is a valuable instrument for measuring heights up to 8000 feet, but at greater elevations it is quite unreliable. It should be sent to Kew Observatory to be tested and have its errors determined before and after it has been used by a traveller for the purpose of measuring heights.

In observing with the aneroid, the instrument should always be in the same position, as, for instance, with its face horizontal; merely altering the position affects most aneroids with a very sensible difference of reading.

Measurement of Heights with the Aneroid:—To measure the difference in height between two stations, two instruments should be used and the readings taken simultaneously at both stations; but it frequently happens that this is impossible, in which case the observations should be taken in the following manner:—Take the reading of the aneroid and the temperature of the air, *in the shade*, at the lower station; repeat this at the upper station, and again at the lower station on returning to it, but before taking this last reading a short time should be allowed to let the aneroid take up its proper working, as a descent will always in a greater or less degree affect it.

On leaving a station to which it is not intended to return, the reading of the aneroid should be taken, and the temperature in the *shade*; during the day's journey the difference between a reading taken and that taken at starting will approximately give the difference of height unless there has been some atmospheric change. This is only a very rough way of ascertaining whether a party, passing through a hilly country, has ascended or descended; for the accurate method of computing the difference of height of two stations, see example (p. 181).

*Route Survey with Prismatic Compass, Boiling-point Thermometer,
and Aneroid.*

For the purpose of illustration, suppose the following to be an extract from a traveller's journal:—

June 1st.—Camp at the foot of hill A.

To measure the height of the hill, A, above the camp, I read the aneroid and thermometer, first at camp and then on its summit, with the following results:—At Camp, aneroid, 25·67 inches; temperature in the shade, 70° Fahr.; at the summit of the hill, aneroid, 24·25 inches; temperature in the shade, 65° Fahr. At the summit of hill, A, I took the following bearings, and a rough sketch of the country to the north, marking all prominent objects with a letter corresponding to the letter given to the bearing.

Bearings taken at A: G 351° 30'; F 340°; E 326°; D 308°; C 300°; B 283°. All bearings magnetic.

June 2nd, 8 A.M.—Aneroid, 25·7 inches; temperature in shade, 78° Fahr. Struck camp, and travelled in a direct line towards hill marked E in the sketch, and at a distance, which I estimated to be fifteen geographical miles we arrived at the right bank of a river, where we camped for the night. The country over which we have passed this day is destitute of trees, sandy, with patches of grass here and there, and gradually slopes downwards from our last camp to our present position. 6 P.M.: aneroid, 25·98 inches; temperature in the shade, 68° Fahr.; took the following bearings:—

Bearings taken at Camp, 2, by River: D 270°; B 204°; A 146°; G 102°. All bearings magnetic.

June 3rd, 8 A.M.—Aneroid, 26·05 inches; temperature in shade, 78° Fahr. Struck camp and forded the river, which, after winding in an easterly direction from the hill, marked D in the sketch, to a point one and a half miles N.E. by E. of the ford, takes a bend to the S.E., passing to the west of the hill marked G on the sketch. At a distance of one mile below the ford a large stream from the north flows into the river. Continued to travel in the direction of E, and at noon found that we had arrived at a point where C and F and our position were in one line of bearing—164° and 244° magnetic; during our halt, boiled a thermometer and read the aneroid with the following results: water boiled at 204·3°; aneroid, 25·62

inches; temperature in the shade, 71° Fahr. 3 P.M. Resumed our journey, and at 6:30 P.M. reached the summit of the hill, E, where we camped; estimated distance travelled, nineteen geographical miles. Aneroid, 24.60 inches; water boiled at 202.3° ; temperature in the shade, 64° Fahr. Since leaving camp this morning the country through which we passed was covered with vegetation, and we had the large stream to the right of us throughout the day. From this hill, E, we can see that the river we forded this morning takes its rise in the range of hills to the west of our present position, and flows with a winding course through the valley at the foot of the hill, D, and so past our last camping-ground.

Bearings taken at E: C $236^{\circ} 30'$, and southern end of summit of same range, H 215° ; D 174° ; B 169° ; A 146° ; G $131^{\circ} 30'$; F 108° . All bearings magnetic.

June 4th, 8 A.M.—Aneroid, 24.65 inches; temperature in shade, 66° Fahr. Set out in a N.W. direction, and having no prominent object in view on the line of march, I noticed the direction in which my shadow was cast, and by this means, allowing for the sun's apparent motion, I avoided making any general deviation from the direction in which I wished to travel. Arriving at a small lake, we camped, having come an estimated distance of twelve geographical miles. Fixed the position of the lake by bearings of C and E. Aneroid, 25.50 inches; temperature in shade, 70° Fahr.

Bearings taken at Camp, near Lake: C $203^{\circ} 30'$; H $185^{\circ} 34'$; E $116^{\circ} 30'$. All bearings magnetic.

To Plot the Bearings:—The bearings should be corrected for the variation of compass. This is a known quantity and can be ascertained approximately from the annexed map;* otherwise the traveller must plot his work on the magnetic meridian, and expressly state that he has done so. In the present instance we will suppose the variation to be 20° east, and as no sextant has been used to take the necessary observations for finding errors caused by local attraction (see pp. 65 and 66), this will be the only correction, and must be applied as directed on page 16; thus the bearing $351^{\circ} 30'$ magnetic, will be

* In the present case it is supposed that the traveller is not provided with the instruments necessary to take observations for finding the true bearing by a heavenly body.

1880.

rc.

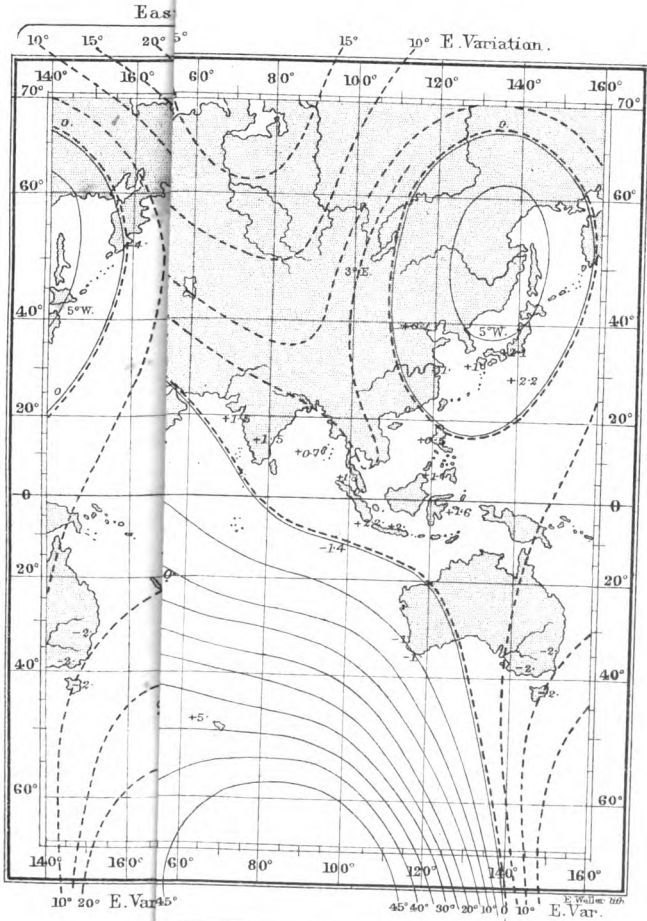

ariation.

371° 30' true, and so on. Having first corrected all the bearings in the manner described, lay down on the paper a line representing the true meridian, i.e. the true north and south, and another at right angles to it, representing true east and west; then through the station, A, with a pencil, draw a line parallel to the true meridian, place the centre mark of the protractor on A, and taking care to see that the 360° of the protractor is on the line drawn through the station, A, set off the corrected bearings as marked on the protractor; this operation must be repeated at every station where bearings have been taken, and the intersection of two lines of bearing of any one point, as taken from two different stations, will fix the position of that point with reference to those stations. The aneroid readings, and the boiling-point, furnish us with the means of ascertaining the difference in height of two stations, and may be computed by the tables (see p. 181), or, where the height is not considerable, by a simple arithmetical process as follows:—

Take the sum and difference of the aneroid readings, at the upper and lower station, get the mean of the temperature in the shade at the two stations. Then, sum of readings : difference of readings :: 55,000 : the difference in height. Increase the result thus found by $\frac{1}{435}$ of itself for every degree that the mean temperature in the shade at the two stations exceeds 55°; subtract the like amount if it is below 55°. The aneroid readings, in the example, computed by the tables and this formula, will show a very close agreement.

	Approximate Method. Feet.	By Tables. Feet.
A, above Camp 1	1608·5	1603·8
1st Camp above 2nd Camp	310	308·8
Foot of Range above 2nd Camp	477·2	475·9
Height of Range E	1148·2	1145·0
" by Boiling point	1155·3
E above Lake	959·2	956·5

For plotting the work in the field, a scale of one inch to the geographical mile will exhibit all the main features of a country traversed in a day's journey. Special plans must be drawn on a scale suited to the area they are intended to represent; but whatever scale is chosen for the field work, it should be large enough to admit of considerable reduction in the fair

plan, as by this process all errors are diminished. The projection of maps is purposely omitted here, as it is dealt with separately (see p. 104); it will, however, be of great assistance to the traveller if he provides himself with a blank map, on the scale of ten geographical miles to an inch, of sufficient range in latitude and longitude to include the country he intends to explore; he should also procure some paper ruled with dark lines into inch squares, and these again subdivided into five smaller squares; this will be useful to him for plotting his work in the field, and should be made up in the form of an ordinary sketching block. Should the latitude and longitude of the point of departure be known, the latitude and longitude of any place on his route can be approximately determined by working the traverse as directed in articles 286 and 324 of Raper, or pages 71-73 and 99 of Norie. It must not, however, be supposed that an accurate survey of a large tract of country can be made with the aneroid, prismatic compass, and boiling-point thermometer; the most that a traveller could expect to do with the aid of these instruments would be to make a rough sketch of the country through which he passed; but instances are not wanting where travellers, by a judicious use of these simple instruments, have added very considerably to our geographical knowledge. The map of Schweinfurth's journey to the Welle is an example of what can be done with the material furnished by such observations.

The weak points in this method of surveying are the errors caused by false estimates of the distance travelled, and those arising from the effects of local attraction on the compass. Knowing these sources of error, every care should be taken to guard against them. With regard to distance, the only safe way of estimating it, is by carefully noting the time occupied in passing from one place to another; in almost all countries bodies of men have a nearly uniform rate of progression, and by taking an early opportunity of noting this rate, the distance traversed in a known period of time can be fairly estimated. Schweinfurth, before setting out on his great journey to the Welle, carefully noted the time which it took him to pass over a known distance at a regular pace, to which he had trained himself; and truly wonderful results have been attained by native surveyors in India by following the same plan. The only precautions that can be taken against the effects of local attraction on the compass, are, to be careful when taking a bearing to put all arms,

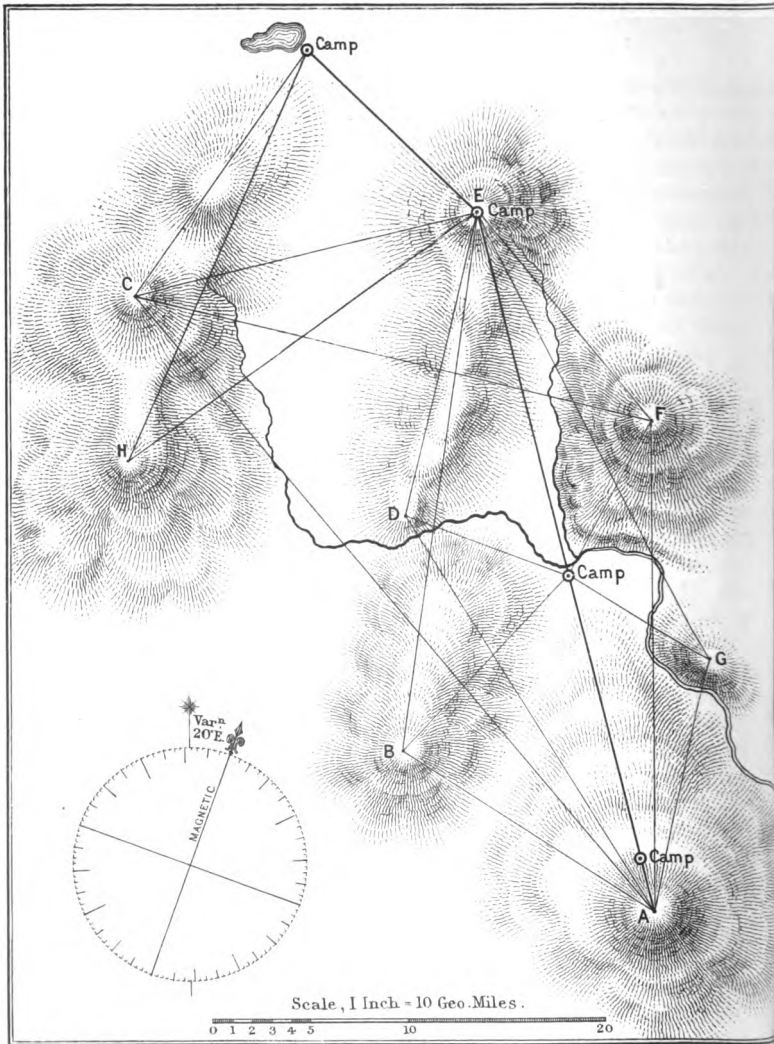

Edw. M.

such as muskets, at some distance from the compass; as a general rule, where possible, to avoid all rocks; and to take bearings both forward and backward on the route travelled, taking their mean as the magnetic direction of the route. In a country thickly covered with forest it is most difficult to distinguish landmarks. The traveller may, however, sometimes leave a mark recognizable at some miles distance by giving a little consideration to it, and knowing the direction in which he is proceeding.

Enter every observation, and change made in the general direction travelled, with the date and time, in the journal; as without attention to this, much valuable information may be lost. When preparing MS. to be sent home for publication, write each of the native names *at least once*, in printing character. Numerous errors and great loss of time frequently result from the attempt to decipher proper names written by travellers in their ordinary handwriting only.

The bearings given in the journal have been laid down on the annexed map, corrected for 20° easterly variation, and will serve to illustrate the manner in which this portion of the work is done.

4. EXTEMPORARY MEASUREMENTS.

Rough angular measurements may be taken by the span at arm's length. From the end of the thumb to the end of the middle finger subtends an angle of 15° ; the full span to the end of the little finger subtends an angle of 18° . This may be easily checked by spanning round the horizon; twenty spans make the circuit. It is at all times well to know the length of the different joints of the limbs. Suppose the nail-joint of the forefinger to be 1 inch, the next joint will be $1\frac{1}{2}$ inches, the next 2 inches, and from the knuckle to the wrist 4 inches; in this case the finger is bent, so that each joint may be measured separately, though, when held straight, the distance from the tip of the forefinger to the wrist would be only 7 inches. The span with thumb and forefinger would be 8 inches, and with the thumb and any of the other three 9 inches, or equal to the length of the foot; from the wrist to the elbow would be 10 inches, and from elbow to forefinger 17 inches, and from collar-bone to forefinger 2 feet 8 inches; height to the middle of the knee-

cap 18 inches. From the elbow to the forefinger is usually called a cubit, but it is seldom strictly so, an English cubit being generally stated as 18 inches. In like manner the full stretch of the extended arms is called a fathom; but it is generally somewhat less.

The pace is commonly supposed to be $2\frac{1}{2}$ feet, but this is a most uncertain mode of measurement. Very few men, *without practice*, can take correctly a hundred consecutive steps or paces of the same length. Practice will determine the amount of ground covered in a certain number of paces, if tried over known distances; it of course varies, but from experiment the mean has been found nearly as follows:

Pacing, at 30 inches per pace, of 108 in a minute, equals 270 feet, or 3.068 statute, or 2.66 geographical miles per hour.

Pacing quickly, at 30 inches per pace, of 120 in a minute, equals 300 feet, or 3.41 statute, or 2.96 geographical miles per hour.

Pacing slowly, at 36 inches, may average 60 per minute, equals 180 feet, or 2.04 statute, or 1.78 geographical miles per hour.

The height of a tree, or other accessible object, may be found approximately by walking away from it, until, with your back to the tree, by bowing your head down as far as you can, and looking between your legs, the tree top is just seen; then pace the distance to the tree, and this will be its height. This method is in common use in the logging camps of North-West America, and from constant practice the backwoodsman will tell to a few feet how far the top of a tree, he is going to cut down, will reach. The legs must be kept straight, and only sufficient space left just to see between them.

Sound travels at the rate of about 1130 feet in one second in calm weather and temperature 60° Fahr.; a moderate breeze accelerates or retards sound by about 20 feet in a second. When a gun is used to measure distance it should always be pointed at an angle of about 45° to the horizon. This method will be found most useful in making rough surveys of winding rivers or lakes, where it is impossible to land on account of the dense undergrowth or the swampy nature of the banks. Great accuracy may be obtained if a gun is fired at each end. The thermometer should also be taken and recorded in order that the distances may be corrected for temperature in the fair plan.

To set off a Right Angle from any point on the ground by means of a Rope.

To set off from any point A, a line at right angles to a given direction, as A E, measure an equal distance on each side of A, in the same straight line as A E, this equal distance being about one-fourth of the length of the rope. Let C and D be these points. Fasten the ends of the rope at C and D, and having ascertained the centre of the rope by doubling it, the centre should be drawn out towards B, until D B and C B are tight. Then E A B will be a right angle; therefore, as we are thus able to set off a right angle to any line, the distance of any inaccessible object may be obtained by either of the three following ways:—

. E

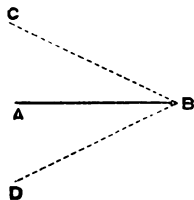

To find the Distance of an inaccessible object with a Measuring Line.

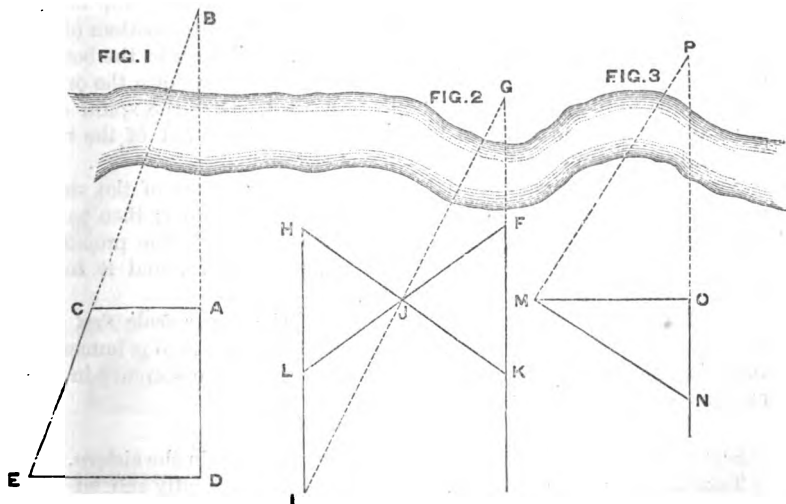

By Fig. 1.—From the line $A D$ measure off the perpendiculars $A C$, $D E$, ranging the point C in line with $E B$, then

$$A B = \frac{A C \times A D}{D E - A C}.$$

By Fig. 2.—Fix any convenient points H and K . Join $H K$ and bisect it in J ; make $J L = J F$, and range I in line with $H L$ and with $J G$; then $L I = F G$.

By Fig. 3.—Set off $O M$ at right angles to $O P$, and $M N$ at right angles to $M P$; then $O P = \frac{O M^2}{O N}$.

5. CAPTAIN GEORGE'S MERCURIAL BAROMETER.

To Fill:—Spiral Cord Method.

Take the tube out of the tripod stand, unscrew the short part of brass tube and take out the tube; insert it carefully into the cistern with a screw-like motion through the rubber plug until the end of the tube is opposite the scratch in the middle of the cistern. Then screw on the smaller half of the brass tube and pass it down through the top of the stand (cistern uppermost) until it rests on it. Take off the bottom of the cistern and thrust the feather end of the spiral cord down to the bottom of the tube. Now take the filterer and pour the mercury down the orifice of the tube until the cistern and tube are filled. Give the spiral cord circular motion from right to left until it works itself out of the tube. Then fill in more mercury up to the top of cistern.

Screw on the lower stopper tight, take the barometer out of the stand, and invert it: try if it gives a sharp metallic click-like sound: then pass it upwards through the centre of the tripod stand, guiding the projecting arms through the notches, and giving it a quarter turn, land it in its place, where it will swing perpendicular.

Let it rest a few minutes, and then read off the upper scale *first* and then the lower; their *difference* is the true reading, if the zero is immersed in the mercury; but their *sum* if the zero is above the mercury in the cistern.

To Empty the Barometer.

Screw down the flange, and thus secure the mercury in the cistern.

Take the barometer out of the stand. Reverse it gently and let the

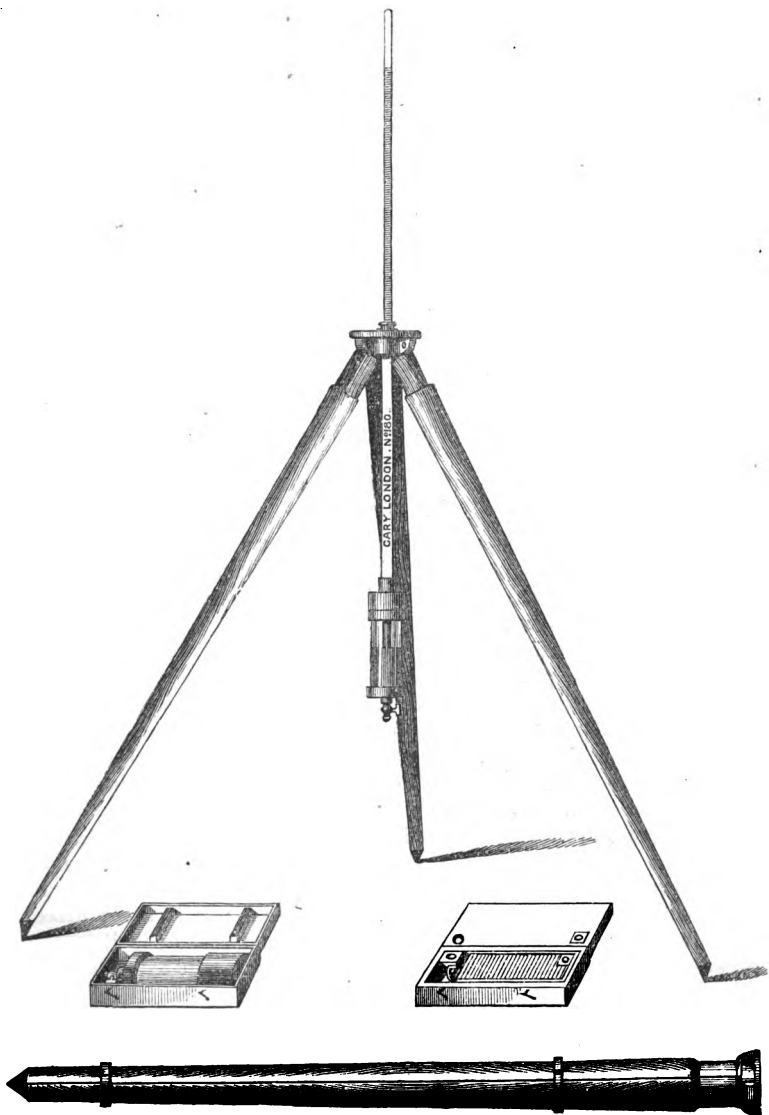

GEORGE'S MERCURIAL BAROMETER.

round end of the tube rest on the floor, while you reverse your right hand.

Unscrew the lower cap, tapping it gently to shake off the globules into the cistern.

Empty out the mercury into the wooden box, holding the fore-finger across the lower part of the orifice of the cistern. This prevents its rushing out too quick, and avoids spilling the mercury. Place the empty barometer in its stand.

Pour the mercury from the wooden box into the iron bottle. Secure it by the screw plug. But if you are going to re-fill, take out the upper plug and screw on the filterer.

Clean the tube and cistern, inside and out, and it will be ready for re-filling again, or being stowed away in its case and stand.

6. DESCRIPTION AND ADJUSTMENTS OF THE SIX-INCH TRANSIT THEODOLITE.

The following are the names of the various parts of this instrument to which reference is made in the remarks on its adjustments.

A is the *Vernier-plate*; it is furnished with two verniers a 180° apart, graduated to $10'$. B is the *Lower plate*; it is graduated into 360° , each degree being again subdivided into $10'$, and can with the vernier be read to $10'$. These two plates combined are called the *Horizontal limb*, and revolve independently of one another, but when required can be made to move together by tightening the *Clamp-screw* C; the slow motion is obtained by the *Tangent-screw* D; the lower plate has also a *Clamp* E, and a *Tangent-screw* F. G G, the *Parallel plates*, are held together by the *Horizontal axis*, H. There are four *Levelling screws*, I, I, I, I, one of which is not shown in the drawing. K is the *Tripod*, on which the instrument is firmly screwed, underneath, in the centre, there is a hook (not shown in the drawing) from which to suspend a plummet in order to indicate the exact position where the station peg is to be driven into the ground. The vernier-plate carries a compass, L, in its centre between the supports of the *Telescope*, O; it is graduated into 360° , and fitted with a screw, M, to lift the magnetic needle off its centre when not in use. The two *Frames*, N N, carry the Bearings, V, for the telescope, with its level, P, and the graduated circle, R, called the *Vertical limb*, with its two verniers, s s, and *Microscopes*, m m. The vertical

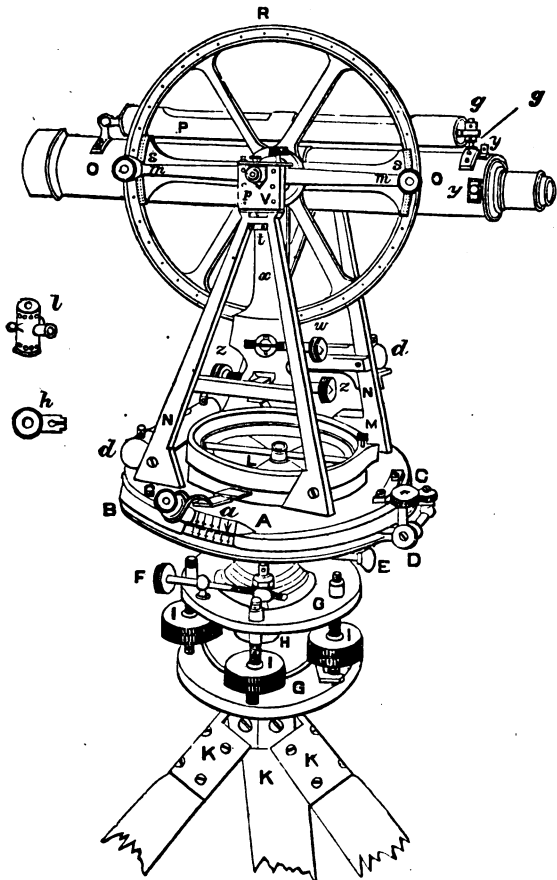

TRANSIT THEODOLITE.

limb is graduated from 0° to 90° through one quadrant, then again from 90° to 0° in the next quadrant, and so on round the circle; the degrees are subdivided into $10'$, and with the verniers, read to $10''$. The horizontal axis of the telescope is formed of two cones, the larger ends of which are attached to the telescope tube, while the small ends, called the *Pivots*, p , are ground into two perfectly equal cylinders; the pivot which does not carry the vertical limb, is pierced, and allows the light of a lamp to fall upon a small reflector (not shown in the drawing) which is screwed into the centre, on the axis of the telescope, and inclined to it at an angle of 45° , by which means the light is thrown directly down the telescope, and illuminates the fine threads, or web, attached to a *Diaphragm* inside the telescope, which is kept in its place and adjusted by the screws yy , of which there are four. The *Index-bar*, x , is fixed in its place by the *Clip-screws*, zz . The vertical-limb is furnished with a *Clamp* (not shown in the drawing), and a *Tangent-screw*. w ; dd are levels at right angles to one another; l and h are the small lantern, and its holder, which fits into a slot in the frame on the side opposite to the vertical limb; gg are capstan-headed screws for adjusting the telescope level. The telescope is brought to focus by a milled screw not far from the object-glass; a diagonal eye-piece is also supplied with the instrument, and is extremely useful in astronomical observations; t is a capstan-headed screw used in adjusting the axis of the telescope.

Adjustments.

Parallax.—This adjustment is made by moving the sliding tube of the eye-piece until the threads of diaphragm are seen sharply defined against the sky, and then by pointing the telescope O at some object, and bringing it to the proper focus by the milled head screw near the object-glass.

Adjustment for Collimation.—Set the instrument as nearly level as can be done with the eye, then clamp the lower plate B , and, having unclamped the vernier-plate A , direct the telescope on some well defined object, and bring it into coincidence with the point of intersection of the threads of the diaphragm; take the reading on the horizontal limb AB , suppose it to be 20° , then move the vernier-plate A , half round, turn the telescope over, and again intersect the object, taking the reading on the horizontal limb, suppose $200^{\circ} 2' 30''$, take the difference between this and the first reading $+ 180^{\circ}$ (which in the present case would be 200°),

and the difference would be $2' 30''$; halve this difference, and subtract it from the second reading, when it is greater than the first reading $+ 180^\circ$, and add it when it is less; this is the mean reading ($= 200^\circ 1' 15''$); set and clamp the instrument to this mean reading, and intersect the object by means of the capstan-headed screws yy , which move the diaphragm, taking care to loosen one before moving the other. Repeat this operation until the readings taken with the instrument in these two different positions, face right and face left, differ from one another by 180° .

Adjustment of the Telescope Level.—Level the instrument carefully on the azimuth axis H, by means of the levels dd on the horizontal limb A B; next, take a pair of verticals, i.e. on faces right and left, to any well-defined *terrestrial* object; set the vertical circle R to the mean of these readings, and clamp it; now intersect the object, using the two screws zz , which clip the limb of the vertical circle x to the stud in the frames NN, which carry the bearings, V, for the telescope, and *not* the tangent screw W; then repeat the process as before. Remember that after each pair of readings, the mean is to be taken, and the object intersected by the clip-screws zz , and not by the tangent screw W; and when the readings on the right face agree with the left face, the index error will be 0. Next clamp the vertical circle R at $0^\circ 0' 0''$ altitude, and bring the bubble of the telescope level to the middle of its run by means of its adjusting screws g , and the level will be in adjustment. With regard to the clips zz , which keep the vernier ss in position, never unscrew *both* after the adjustment has been made; but to release the vertical circle before putting the instrument into its box, unscrew only one of the clips, and mark it so that it may be known, and use this *same* screw when setting up the instrument again. The other clip-screw should never be touched; and, indeed, it would be an improvement if one of the clip-screws were fitted with a lock-nut, by which it would be kept in its proper place, and at once be distinguished from the working screw.

Adjustment of the horizontal limb.—Tighten the clamp-screw E, unclamp the vernier-plate A, and turn it round until the telescope is immediately over two of the parallel plate-screws II; bring the bubble in the telescope level P to the middle of its run by turning the tangent-screw W; turn the vernier-plate 180° , so as to bring the telescope again over the same screws, but with its ends in a reverse position. If the bubble of the telescope level does not remain in the middle of its run, bring it back

to that position, half by the parallel plate-screws I I, and half by the tangent-screw W. This operation must be repeated until the bubble remains accurately in the centre of its run in both positions of the telescope; now turn the vernier-plate A until the telescope is directly over the other pair of parallel plate-screws, and bring the bubble to the middle of its run by turning these screws. The bubble should now retain its position, while the vernier-plate is turned completely round, showing that the internal azimuth axis, about which it turns, is truly vertical. Clamp the vernier-plate to the lower plate by turning the clamp-screw C, and loosen the clamp-screw E; move the instrument round its azimuthal axis, and if the bubble retains its central position during a complete revolution, the external azimuth is truly parallel with the internal; when this is not the case, the instrument must be sent to the maker, as this fault cannot be remedied by the traveller.

It is most probable that the level on the vernier-plate will now be found out of adjustment, and the bubbles must be brought to the middle of their run by turning the capstan-head screws at the end of each of them.

Horizontality of the Axis of the Telescope.—This is to be tested by the striding-level, which is supplied with the instrument. Apply it to the pivots *p*, and if the bubble is not in the middle of its run, bring it to that position by turning the capstan-headed screws *t* under the movable bearing. If there is no *striding-level*, this adjustment can be tested by observing a long plumb-line, first making the intersection of the threads in the diaphragm coincide with this line, and then, if the point of intersection moves along the line when the telescope is elevated or depressed, the adjustment is perfect; if not, it must be made to do so by turning the capstan-headed screws.

The adjustments can be tested in the following simple manner:—With the plummet supplied with the instrument, find the exact central spot over which the instrument stands; drive a peg into this place, and fasten a cord to the peg; now go in any direction, for say 40 feet, and drive in another peg, stretch the line tight between these pegs, and then intersect the line with the threads in the diaphragm, clamp the horizontal plates, and if the intersection remains perfect while the telescope is moved on its axis, the adjustments are so far correct. Next move the outer peg about 90° (with the same radius) from its first position, and again drive it into the ground and draw the line tight as before; unclamp the vernier-plate,

keeping the lower plate clamped, and repeat the previous operation, if the point of intersection of the threads in the diaphragm keep on the line while the telescope is moved on its axis, the theodolite is in adjustment, if not, the adjustments should be gone over again.

The Vernier of the Vertical limb.—When the foregoing adjustments have been made, set the vernier of the vertical limb to $0^{\circ} 0' 0''$, and bring the bubble of the telescope level to the middle of its run by turning the clip screws. The instrument will now be in adjustment and ready for use.

All first-class instrument makers are very careful, for the sake of their reputation, to see that the theodolite is in perfect adjustment when it leaves their hands, and with the careful treatment which this instrument should always receive, is not likely to get out of order; it is, nevertheless, necessary from time to time to test these adjustments.

7. THE SEXTANT AND ITS ADJUSTMENTS.

The principle on which the sextant is constructed is this:—that the angle between the first and last directions of a ray which has suffered two reflections in one plane, is equal to twice the inclination of the reflecting surfaces to each other; the arc on which the angle is measured must therefore be divided into double the number of degrees which properly belong to an arc of the same extent. With this instrument we can measure the angle between two objects, in whatever direction they may be placed, provided the angle is within its limits.

With the aid of the following figure, the different parts of the sextant, with their names, may be distinguished. A is a plane mirror called the index glass; it is set in a frame, and is fixed on a centre perpendicular to the plane of the instrument; it moves with the index bar, BC, the end of which C slides over the arc, EF, which is graduated (on an inlaid plate of platinum) from 0° to about 140° ; each of these degrees, according to the radius of the instrument, is divided into $10'$ or $20'$, and these are subdivided by the vernier, D, into $10''$ or $20''$; these divisions on the arc are continued a short distance on the other side of zero (0°) towards F, forming what is termed the arc of excess. The index is secured to the arc by the clamp screw G, which must be released when the index has to be moved over a large portion of the arc. In order to obtain the slow motion necessary for the accurate measurement of an angle, a tangent screw, H, is fixed to the index, but does not act until the index is fastened

D

by the clamp screw. I is a fixed plane glass, the lower half of which, next to the frame of the instrument, is silvered, and the upper half left clear; it is called the horizon glass, and must be perpendicular to the plane of the instrument, in such a position that its plane shall be parallel to the plane of the index glass when the index points to zero (0°) on the arc; it

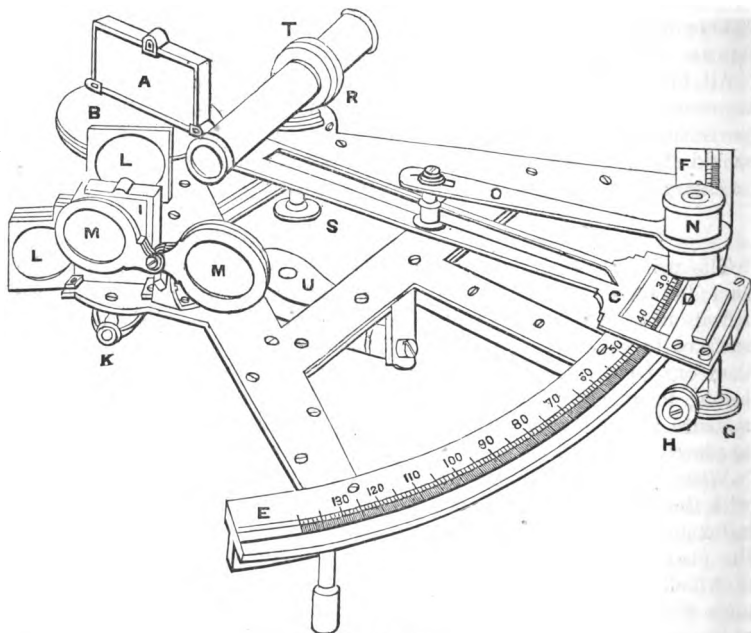

SEXTANT.

is adjusted by means of the screw K.* L and M are coloured glasses of different depths of shade, any one, or more of which, can be turned down before either the index, or horizon glasses to moderate the intensity of

* The form and position of this screw differ very much in different sextants: in some, the adjustment is made by two small screws bearing on the back of the glass.

the light before reaching the eye, when a bright object, such as the sun, is observed. N is a microscope which is carried on a movable arm O, and can be adjusted to read the divisions on the graduated arc and vernier. The telescope, T, is carried by a double ring, R, so constructed that it furnishes means of adjusting the line of collimation; this ring is attached to a stem, S, which can be raised or lowered until objects seen by reflection, and directly, appear of the same brightness. U is the handle which is sometimes fitted with a brass centre, having a hole in it, to admit of its being fastened to a stand.

Adjustments.

The principal adjustments are the following:—

1. To make the index glass perpendicular to the plane of the instrument.
2. To make the horizon glass perpendicular to the plane of the instrument, and parallel to the index glass when the index points to zero (0°) on the arc.
3. To make the axis of the telescope parallel to the plane of the instrument, in which the index moves.

1st Adjustment.—This adjustment rests with the maker; and being once made, cannot be deranged, except by a fall or a blow, against which every precaution must be taken. The instrument should, however, be occasionally verified by the observer in the following manner:—Set the index at 60° ; and, holding the sextant in the left hand, with the right move the index gently backwards and forwards, looking, as you do so, obliquely into the index glass; then, if the image of the arc in the mirror appears in perfect continuation of the arc itself, the adjustment is perfect; when this is not the case, the index glass is out of adjustment. If the derangement is great, the sextant is for the time being useless: if small, it may possibly be remedied by means of certain screws sometimes (though seldom) fitted at the back of the glass; but it is better to leave it alone; an inexperienced observer would most probably only make it worse. A man who has a thorough knowledge of his instrument can take off the frame, and, by hammering and tinkering, get it put square and straight; in replacing it, wedging it up, if necessary for perfect adjustment, with small folds of paper. A very bad derangement may be

put to rights in this way; but it is, very evidently, a thing not to be rashly attempted.

2nd Adjustment.—Having screwed in the telescope, look through it, and the horizon glass at the sun, or still better, a star, and move the index backwards and forwards, on each side of zero (0°), when the reflected image of the object ought to pass exactly over the object itself. If it does not do this, but passes either to the right or left of it, the horizon glass is out of adjustment, and its adjusting screw must be gently turned until the reflected image does pass directly over the object itself.

3rd Adjustment.—Screw the telescope firmly into the collar, turn the eye-piece until two of the wires in the focus of the telescope are parallel to the plane of the instrument. Select two stars, not less distant from each other than 90° , bring them into exact contact at the wire nearest to the plane of the instrument; fix the index, and move the instrument so as to throw the images upon the upper wire; if the contact remains perfect, the adjustment is perfect; if not, it must be rectified by the two opposing screws in the double collar, taking care to slacken one before tightening the other: the one to slacken is that on the side towards which the contact opens.

Index Error.

When the index is set at zero (0°) on the arc, the horizon and index glasses should be parallel, and the two images of a distant object, as a star, should exactly coincide; when this is not the case, it may be remedied by turning a screw in the mounting of the horizon glass. If this adjustment is not made, there will be an error in the place of the *beginning* of the graduation; this is called the *Index Error*; its amount is easily determined, and, as it affects all angles alike, it is usual to admit the existence of this source of error, and apply correction for it, in preference to making the adjustment.

To find the Index Error by a Star.—Set the index at zero (0°), screw in the telescope, and, with the tangent screw, make the two images of a star, as seen through the telescope, coincide; then the reading on the arc will be the index error. Subtractive when the reading is to the left of zero, additive when to the right.

By the Sun.—Clamp the index at about $30'$ to the left of zero, and looking through the telescope at the sun, the images will be seen nearly

in contact; make this contact perfect with the tangent screw, take the reading, and call this "on the arc;" next, set the index, at about 30' to the right of zero, and make the contact of the two images perfect as before, take the reading, and call it "off the arc:" half the difference of these two readings is the Index Error.

Examples.

(1)	' "	(2)	' "
On the arc	33 10	On the arc	29 30
Off the arc	29 30	Off the arc	33 10
	<hr style="width: 50%; margin: 0 auto;"/>		<hr style="width: 50%; margin: 0 auto;"/>
	2) 3 40		2) 3 40
	<hr style="width: 50%; margin: 0 auto;"/>		<hr style="width: 50%; margin: 0 auto;"/>
Index corr. <i>subtract</i> =	<u>1 50</u>	Index corr. <i>add</i> =	<u>1 50</u>

As a check on this observation, for inexperienced observers, it may be noted that one fourth of the sum of the readings on and off the arc, ought to be the sun's semi-diameter, as given in the 'Nautical Almanac.'

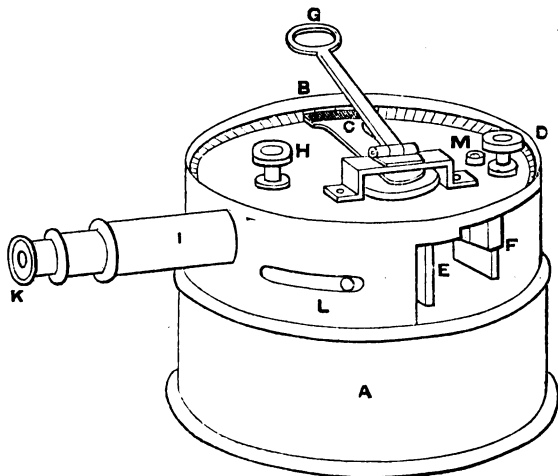

BOX SEXTANT.

8. THE BOX SEXTANT.

The box sextant is constructed on the same principle as the larger sextant; it is enclosed in a brass box, varying in size from 3 to 4 inches in diameter, and from an inch and a half to two inches deep. The instrument, as shown in the drawing, is ready for use: the cover, A, is screwed on to the lower part of the instrument, and serves as a handle when taking an angle; B is a graduated arc, divided into degrees and half degrees; C is the index bar, having a vernier at the end, divided to read the angle to 1'; D is a milled screw by which the index bar is moved; attached to the end of the index bar, on the inside of the box, is the index glass, E; the horizon glass, F, is also inside the box, and has the upper half silvered; G is a small magnifying glass attached to the top, to enable the observer to read the angle more clearly; there are dark glasses, to be used when observing the sun, not shown in the drawing; H is the adjusting screw, which is screwed into the top for safety; it is made with a square, like a watch-key, and when required for use has to be removed from the position shown in the drawing; I is the telescope, which should be fitted with a dark glass, K, at the eye end, to be screwed on when the artificial horizon is used; in taking angles the instrument can be used without the telescope, by drawing the slide, L, over the hole from which the telescope has been removed.

Adjustments.

Having set the index at zero (0°) on the arc, select some object that is sharp and perpendicular, as far distant as possible, to be seen clearly; then, holding the instrument in a horizontal position, look at this object through the eye-hole, and, if the reflected image coincides with the object seen directly, the adjustment is so far correct. Then hold the instrument the contrary way, or vertical, look at some object that is level, and if the reflected and real objects are seen in a straight line this adjustment is also correct; but when this is not the case the adjustment must be made by taking out the key, H, placing it in one of the keyholes, M, either on the top or side of the instrument, and turning it gently until the reflected image of the object coincides with the object seen directly; if the reflected image requires moving up or down, the key must be inserted on the top of the instrument, but when it has to be moved to the

right or left the key must be inserted at the side. These adjustments can be made, when no available objects, such as those mentioned, are in sight, by screwing the dark glass on the eye end of the telescope and looking at the sun (having previously set the index to zero); move the index until the reflected and direct images coincide; if the index then points to zero (0°) the instrument is in adjustment; if not, make the coincidence with the key as above described; a bright star may be used in preference to the sun, in which case the dark glass on the eye end of the telescope will not be required. The adjustment by a terrestrial object is here given to meet the case of an instrument having to be adjusted in the day-time when the sun is not visible. Care should be taken when purchasing a box sextant, to see that the maker has made the box wide enough to admit a finger to wipe the glasses, as dull reflectors much increase the difficulty of observation.

9. THE ARTIFICIAL HORIZON.

The artificial horizon is a reflector, the surface of which is perfectly horizontal; it is used in combination with the sextant for observing altitudes. Though the principle of all is the same, there are several forms of this instrument, the most common, as well as the best, being a small shallow trough, containing pure, clean, quicksilver,* which reflects the image of a celestial body. This is protected from the disturbing effects of the air by a roof, the two sloping sides of which are made of glass plates carefully ground to true planes: these must be carefully examined to see that they are of uniform thickness and density. Captain George's Horizon, in which one glass plate floats on the surface of the mercury, is in some respects more convenient; but it is liable to large errors arising from any disturbance communicated to the mercury, by shaking, by wind, or otherwise, which are more serious

* If the quicksilver is not pure it gives an imperfect reflection, and its level is apt to be untrue. The quicksilver of commerce is generally mixed with lead, bismuth, and zinc, which have to be dissolved out of it by nitric acid; it may however, in case of emergency, be rendered serviceable by shaking it for some considerable time in a bottle with a little powdered sugar, or even sand, and afterwards straining it through a piece of fine linen or chamois leather, but it is a troublesome, and not very satisfactory process.

as the disturbance is not shown by any tremor on the surface. Should the traveller have the misfortune to break one of his glasses, and replace it by one not tested, he must be careful to reverse the roof between two observations, or once in a set. Another form of artificial horizon is the black plate. It consists of a plane of black plate-glass set in a metal frame, and levelled by a bubble. It is very portable, but it cannot be recommended, as its performance can only be satisfactory, when the glass has been ground to a very perfect plane, and when it has been most accurately levelled. Whatever form of artificial horizon is used, care must be taken to keep it clean and free from dust.

10. WATCHES.

The keyless half-chronometer is the most suitable watch for a traveller in wild countries. (The half-chronometer watch is a lever watch, with compensation balance, and a carefully tempered pendulum spring.)

The ordinary pocket chronometer is expensive, and not calculated to stand the rough usage to which most travellers' watches are subjected. The objections to it are: (1.) The extreme delicacy of the escapement, and liability to injury from rust or accident. (2.) Its great liability to stoppage from various causes, such as a sudden jerk when riding or travelling over a rough country; even if in the act of winding it the holder should inadvertently give a circular motion to his hand in a direction opposite to that in which the balance-wheel may be moving at the same instant, it may stop. (When a chronometer is once stopped it will not start again unless a circular motion be given to it.) (3.) The impossibility of its repair when injured, except by highly-skilled workmen, and when very slightly injured, the consequent great disturbance and irregularity in its rate.

Under favourable circumstances, and in skilled hands, pocket chronometers have done good service, but this is exceptional. The minimum price of a good pocket chronometer, in a silver case, is 45*l*.

Half-chronometers are not liable to stop from the before-mentioned causes, unless from rust of an aggravated kind. They are more easily repaired. They may be carried in the pocket under conditions of rough usage, short of actual violence, and under those circumstances they may not fall far short of a chronometer at rest in the regularity of their rates.

During the last twenty years great improvements have been made in the manufacture of the lever escapement compensation balances and the pendulum springs, upon which the ability of a watch to keep a steady rate in a great measure depends; the keyless mechanism has also been perfected, and it is not necessary to open the case of a keyless watch in order to wind it, or to set the hands, thus the works receive increased security from dust and damp, the two great enemies of all time-pieces.

The following is the description of such a watch as would be best suited to a traveller. The watch should be a 16-size silver case half-chronometer; the bezel (or frame which holds the glass) should have neither hinge nor spring, but should fit very closely over the watch-case, and snap tightly when pressed home; great care should be taken to see that the marking of the minutes on the dial is correct, so that in whatever part of the hour circle the minute hand shall point to a division, the seconds' hand shall at the same time point to 0. This perfect coincidence is by no means common; its absence is chiefly due to eccentricity in fixing the dial-plate, and the error is often so great as to be a cause of great annoyance to the traveller, who will have frequent difficulty in deciding as to which minute the seconds belong. The seconds dial-plate should be sunk, and the glass should be thick flat crystal. A good watch of this kind cannot be purchased for less than 20*l*.

The keyless watch has many advantages over the old form, of which the following are some. It cannot be wound the wrong way. It cannot be over-wound. The case has not to be opened either to wind it or to set the hands. With screw caps to cover the push-bar and the winding-button, a watch of this kind has been placed in water, and proved impervious to damp after several hours' immersion. Should the winding mechanism get out of order, the watch can be wound with a common key in the same manner as an ordinary watch. The cost of a good watch of this description is 35*l*.

Care should be taken to wind a watch at about the same hour every day, and as nearly as possible to subject it to the same daily treatment, with regard to its position in the pocket, or the place where it is laid down at night.

In purchasing a watch be sure to go direct to the manufacturers, as such watches as I have mentioned can only be obtained of the best makers. Cheaper watches, purporting to have compensation balances

and the best pendulum springs, may be obtained from many shops; but it will often be found (when too late to replace them) that they are not all they profess to be, that they have never been properly adjusted, and are in consequence, so affected by change of position and temperature as to be useless for scientific purposes.

11. SEXTANT OBSERVATIONS.

Before any good results can be expected from sextant observations, the observer must be able to read the angles quickly and accurately; the only way to become proficient in doing this, is by practising with the instrument, especially at night, when the angles have to be read by the light of a lantern.

To observe the altitude of the sun, using an artificial horizon.—Fill the trough of the horizon with quicksilver, and put on the roof. Put down the suitable shades before the index and horizon glasses, set the index of the sextant to zero (0°); then, with the artificial horizon between yourself and the sun, retire, looking into the horizon, until you see the sun's reflected image in it; look through the telescope collar, or plain tube, and horizon glass of the sextant at the sun itself; unclamp the index, and move it forward. This will bring the reflected image down; follow it with the eye until it slightly overlaps that in the horizon; clamp the index, and screw the inverting telescope into the collar (no time should be lost in doing this, or the sun's image may pass out of the field); then with the tangent screw make the contact perfect. It is always better to bring the object down into the horizon without the telescope; by so doing time is saved, and the unpractised observer is less likely to be mistaken as to what he is observing. The following rule will, however, prevent any such mistake:—In the forenoon, or when the sun is rising, if the lower limb is observed, the images are continually separating; if the upper limb is observed, they are continually overlapping; and the contrary in the afternoon, or when the sun is falling. When the telescope is fitted with a dark shade, to screw on to the eye end, it should be used instead of the movable shades. If a roofed artificial horizon is used, the sides should be plainly marked, and it should be reversed at each set of three altitudes, *except when equal altitudes are observed*, to find the error of the watch, in which case the observations must be taken with the same side of the roof

towards the observer.* In placing the horizon on the ground it should have one of the glazed sides of the roof in a direct line with the sun, so that its sides cast no shadow. Any object seen in the mercury appears to be just as much below the horizontal plane as it really is above it; all angles, therefore, observed in an artificial horizon must be halved, *after* the index correction has been applied.

The foregoing remarks apply equally to stellar observations, the only difference being that no dark shades are required.

Observations for Latitude.

The simplest observation is that for finding the *latitude by meridian altitude of the sun, star, or planet*. Some twenty minutes before apparent noon, when the sun is observed, or before the time of meridian passage of a star or planet, the observer should begin to take careful observations, reading the angles from time to time until the body has reached its greatest altitude; this will be the meridian altitude, and the time when it was taken will be apparent noon, if the sun has been observed.

When the *meridian altitudes of a star above and below the Pole* can be observed, half the sum of the corrected altitudes gives the latitude at once, without any computation. When *the Pole Star* can be observed, the latitude is very easily found by the rule and tables given in the 'Nautical Almanac;' and, as a fairly correct approximation without any calculation at all, the corrected altitude of the Pole Star is the latitude, if the star is observed when β and ζ , or still better, when β and ϵ , *Ursæ Minoris* appears to the eye to be in the same horizontal line; a method, which, as a rough observation, has the advantage of being independent of watch, tables, or 'Nautical Almanac.' The method proposed by Chauvenet, of finding the *latitude by three altitudes of sun or star, taken near the meridian* (and not necessarily on the same side of it), at equal intervals of time, may be useful when the error of the watch is not known.

Let a_1, a_2, a_3 , be the three altitudes (it is better that none of them

* This is by way of precaution against irregularities in the glass plates; and with a roof of known excellence, is hardly necessary.

should be more than $\frac{1}{2}$ -hour from the meridian); A the required meridian altitude; then if

$$q = \frac{[\frac{1}{4}(a_1 \sim a_3)]^2}{a_2 - \frac{1}{2}(a_1 + a_3)}, q \text{ being expressed in seconds of arc, } A = a_2 + q.$$

The meridian altitude being thus determined, the latitude can be found in the usual manner.

Example.

$$\begin{array}{rcl} a_1 = 43^\circ 8' 20'' & a_2 = 43^\circ 15' 30'' & a_3 = 43^\circ 4' 0'' \\ & \frac{1}{2}(a_1 + a_3) = 43 \quad 6 \quad 10 & \\ & a_2 - \frac{1}{2}(a_1 + a_3) = \quad \quad 9 \quad 20 = 560'' & \\ & \frac{1}{4}(a_1 \sim a_3) = \quad \quad 1 \quad 5 = 65'' & \\ \text{hence } q = \frac{65^2}{560} = 8'', \text{ and } a_2 + q = 43^\circ 15' 38''. & & \end{array}$$

As it is at times extremely difficult to determine which is the exact meridian altitude, in consequence of the slow increase in altitude of heavenly bodies when near the meridian, the latitude of a place will in most cases be more surely determined by taking sets of altitudes on either, or both sides of the meridian, and noting the time corresponding to each altitude. These altitudes are taken in the manner previously described, and the observations should be commenced at about a quarter of an hour before the heavenly body observed comes to the meridian, and may be continued until it has passed it by a like space of time. As the sun or star will be rising very slowly the observations should be taken with deliberation, at about minute intervals. Should the sky become overcast, the observations on either side of the meridian can easily be reduced to the meridian altitude, and this circumstance adds considerably to the value of this class of observation. The time must be taken by a watch, whose error on apparent time at place is known. It is from this observation that the latitude by north and south stars is computed, a process that gives more exact results than any other method, excepting those determined by fixed instruments.

By north and south stars are meant stars which pass the meridian to the north and south of the observer's zenith. The following will illustrate the manner in which this observation is taken. Suppose, that on the 1st of December, 1881, we wished to fix the position of the Society's Observa-

tory in latitude, by north and south stars. On looking at the heavens we should see that γ *Pegasi* and γ *Cephei* were well situated for that purpose, and with these stars' right ascensions and the sidereal time at mean noon (taken from the 'Nautical Almanac'), we should find that γ *Cephei* passed the meridian, to the north, at 6h. 51m. 24s., and γ *Pegasi* to the south at 7h. 23m. 57s., thus leaving an interval of 32m. 33s. between the meridian passages. We should commence observing altitudes of γ *Cephei* at 6h. 35m. and continue to do so until 7h. 5m.; we should then turn to γ *Pegasi* and continue our observations of that star until 7h. 40m. We should then compute the latitude by each set of observations and take the mean of their results as the true latitude. This observation may be taken, at the same place, at considerable intervals between the times of the two stars' meridian passage, and indeed days have sometimes been allowed to elapse before the second set of altitudes has been taken; the results, nevertheless, being quite satisfactory: when possible, however, it is better that the two observations should be taken consecutively, so as to ensure similar conditions of weather and refraction. The latitudes obtained from north and south stars are free from all effects of personal or instrumental error, and a little practice will show the traveller how largely this class of errors enter into all his sextant observations, for he will often find that the latitude computed from his north star will differ as much as a mile, or more, from that computed from the altitudes of the south star.

Observations for Time.

By sets of Altitudes.—These observations will give the best results, when the heavenly body observed, is nearly east or west of the observer, and when the altitude is not too small, as this latter would greatly increase the difficulty of observing, and necessitates a larger correction for refraction, which is always a somewhat uncertain quantity, depending as it does on the exact state of the atmosphere. When the heavenly body observed, is less than three hours from the meridian, good results (except in special cases) cannot be obtained. The altitudes are taken in precisely the same manner as the meridian altitude, but in this case sets of three or five are taken in quick succession; the hour, minute, and second when each altitude was taken is entered in the note book with its corresponding altitude. When a set has been taken the times are

added together and the sum divided by the number of altitudes; the altitudes are then added together and the sum divided by their number: the result is the mean of the times and the altitude corresponding to it. The intervals between the observations should be nearly equal; in which case, if the number of altitudes is odd, the mean will not differ much from the middle line and its corresponding altitude. The readings of the barometer and thermometer should be noted.

Equal Altitudes of the Sun, Star, or Planet.—This observation must be commenced when the heavenly body observed is three or four hours east of the meridian. Having placed the artificial horizon in its proper position, bring down the reflected image of the object with the sextant until it is in contact with the image in the horizon, then advance the index until it points to a whole degree, for example 40° , and looking through the telescope at the image reflected by the sextant mirrors, wait until it attains this altitude, note the time; advance the index $20'$, to $40^{\circ} 20'$, and wait until this altitude is reached, note the time; again advance the index $20'$, to $40^{\circ} 40'$, and in like manner wait till this altitude is attained, note the time. Repeat this operation as often as convenient, nine such observations will be ample; keep the index clamped at the last altitude taken, and be very careful not to disturb it. The heavenly body observed will, of course, at some time, have the same altitude when it is west of the meridian, and this will be the case when it is *about* the same interval, in time, from it. The observer must therefore watch until the last altitude taken is again furnished, note the time when this takes place, and couple it in his note-book with the time when the heavenly body had the same altitude on the other side of the meridian; move the index *back* $20'$ and wait until this altitude is furnished, note the time, and again couple it with the time when the same altitude was before taken, and so on through the set, moving the index *back* after each sight by the exact amount it was moved forward when the object was east of the meridian, or rising. When an artificial horizon is used, equal altitudes of a star should be taken in preference to those of the sun, for, as the images of the star are but small luminous points, there cannot be any great error in the observation if they are made to touch, while in the case of the sun, exact contacts are by no means so easy to make. The computation necessary to find the error of the watch, by equal altitudes of a star, is extremely short and simple, and therefore best suited to the

ordinary traveller, as the declination of a star may, for the purposes of this observation, be considered constant, there is no necessity to compute the equation of equal altitudes, which must always be done in the case of the solar observation. The number of minutes by which the index is to be advanced or put back must depend on the rapidity with which the heavenly body is changing its altitude; it has here been mentioned as 20' to illustrate the manner in which the observation is taken; but no general rule can be given for this; it is a matter in which the observer must use his own discretion. The same side of the roof of the artificial horizon must always be used for both sets of observations.

Equal Altitudes of a Star on the same side of the Meridian on different nights.—Observe the altitude of a star at any time, note the time and the altitude. After an interval of some days, for example four days, set the index to the altitude noted, and take the time when the star attains it; then, as a star comes to the meridian exactly 3m. 55.9ls. earlier every day, multiply this interval by the number of days elapsed, and subtract the product from the time when the first altitude was taken, the result will be the time the watch should show; any difference between this result and the time the watch shows is the error for the interval, which, divided by the number of days, gives its daily rate; thus, if a watch showed 9h. 50m. 8s., when an observation of a star was taken June 20th, and on June 24th showed 9h. 34m. 10s., when the same star had the same altitude, its daily rate would be 3.6s. losing:—

	H.	M.	S.
1st time	9	50	8
3m. 55s. 9l × 4 =		15	43.6
Time watch should show	9	34	24.4
2nd time	9	34	10
Losing in 4 days	14.4 ∴ daily rate 3.6 secs.		

This observation should only be taken when the star has a considerable altitude, so as to reduce the errors caused by refraction, and can only be used when a halt of some days is made, as any change in latitude would be followed by a change of altitude.

To measure the Angular Distance between two Objects.

When the horizontal angles between terrestrial objects have to be taken with the sextant, the index is set to zero (0°), and the instrument must be held in the left hand in such a manner that its plane is parallel to an imaginary line joining the two objects; put back all the dark shades, and, looking through the telescope collar and the horizon glass at the *right* hand object, unclamp the index and move it slowly forward until the reflected image in the mirror of the horizon glass coincides with the other object seen directly; clamp the index and make the coincidence perfect with the tangent screw, then read the angle. Make it a rule to commence taking the angles from the object farthest to the right, then from the next farthest, and so on, always working from right to left. By so doing mistakes will often be prevented in plotting the work, and you will be able to recognise the objects from which angles have been measured in your rough sketch. Avoid very large or very small angles, as they may cause considerable errors in the positions assigned. Should it be required to measure the horizontal angle between two objects, one of which is at a considerable elevation above the other, as a tree on a plain and a mark on the top of a hill, it will be necessary to select some object immediately below the mark on the hill, and as nearly as possible on the same level as the tree, and measure the angle subtended by them. If no object in a suitable position can be seen, select some point about 90° or 100° from one of the objects and observe the angles between each object and that point; the difference between these two angles will be the horizontal angle, nearly. Should the angle be too large to be taken in one measurement, the object to the right must be brought by reflection to some well-defined mark, and the reading taken, the angle must then be measured between the mark and the other object, the sum of these readings will be the angle required. Though the angles measured with the sextant are seldom, strictly speaking, the true horizontal angles, yet the errors arising from their obliquity are extremely small, if they have been well chosen, and indeed would be scarcely discernible, in work plotted with the ordinary protractor, which is only divided to $30'$. A reference to the following diagrams will, it is hoped, make the previous remarks on this subject more clearly understood.

In Fig. 1 let A B be two objects, O the place of the observer, then the objects would appear in the horizon glass as shown in Fig. 2, when the

Fig. 1.

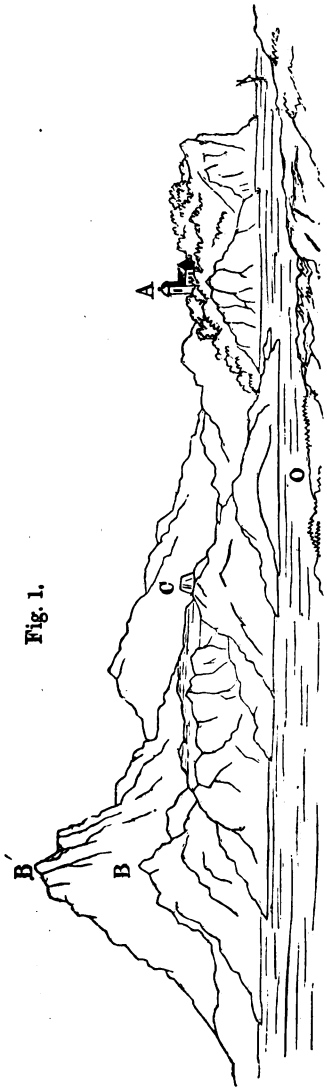

Fig. 2.

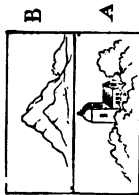
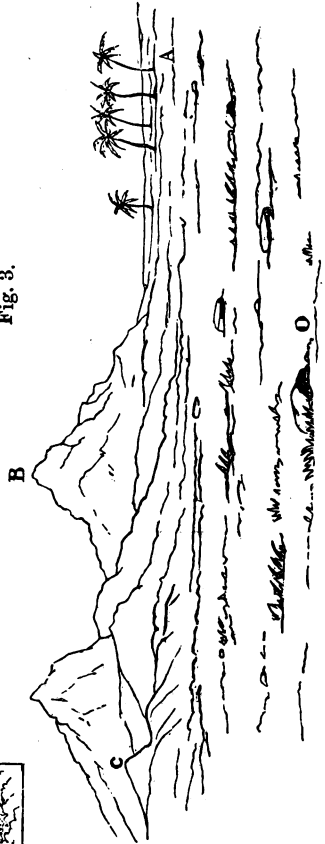

Fig. 3.



angle was taken; A being seen in the mirror, B by direct vision through the unsilvered part. If the angle $A O B$ had to be taken by two measurements, $A O C$ would have to be taken first, and then the angle $C O B$; the sum of these two angles, which is the angle $A O B$, is the horizontal angle between A and B', very nearly, because B is directly beneath B', and is more nearly in the same horizontal plane as A. When a box sextant is used the reflected image is seen above the object by direct vision. In Fig. 3, if the horizontal angle between A and B had to be measured, select a point such as C, more than 90° from A, and at O, the place of the observer, take the angles $A O C$ and $B O C$, the difference of these two angles will be more nearly the horizontal angle between A B at O, than the angle $A O B$.

TABLE FOR ASCERTAINING HEIGHTS AND DISTANCES BY THE BOX-SEXTANT.

	Mul.	Angle.	Angle.	Div.
	1	45 00	45 00	1
	2	63 26	26 34	2
	3	71 34	18 26	3
	4	75 58	14 02	4
	5	78 41	11 19	5
	6	80 32	9 28	6
	8	82 52	7 08	8
	10	84 17	5 43	10

The sextant being set to any angle contained in the Table, any height or distance of accessible or inaccessible objects may be obtained in a very simple and expeditious manner. Make a mark on the object, if accessible, to the height of the eye; set the index to any angle from the Table, and advance or go backwards from the object until, by reflection, the top of the object is brought by the mirrors to coincide with the mark first made. If the angle be greater than 45° , multiply the distance to the object by the number in the next column to the angle in the Table; if the angle be less than 45° , divide, and the result will be the height of the object from the mark; to which add the height of the eye.

If the object is inaccessible, set the index to the greatest angle in the table, that the least distance from the object will admit of; move back-

wards and forwards until the top of the object is reflected level with the eye; at this place set up a staff equal to the height of the eye. Then set the index to any of the lesser angles; go back in a line with the object, until the top is made to appear on the level with the top of the mark before made; fix here another mark; measure the distance between the two marks set up; divide this by the difference of the numbers corresponding to the angles made use of, and the quotient will be the height of the object from the mark; to which add the height of the eye.

If the index is set at 45° , the distance is equal to the height, minus the height of the eye.

At a given point to mark off a line perpendicular to any given direction. If this direction is not sufficiently distinguished by some natural object, such as a tree, or a white stone, mark it by a flag set up as far off as convenient; then, standing at the given point, with the sextant set to 90° , make a man, bearing a flag, stand in a line estimated as the perpendicular. Motion him right or left until his flag can be seen, by reflection, to coincide with the other. There let him plant his flag, so marking the direction of the perpendicular.

Of course any other direction can be marked in the same way, setting off the required angle on the sextant, instead of the 90° .

Between the Moon and Sun.—As the enlightened limb of the moon is always nearest to the sun, the angular distance measured is always that of the near limbs; but since, on account of her comparatively feeble light, it is necessary to observe the moon by direct vision, and since the sun at the time of observation may be either to the east or west of the moon, the sextant has to be held with its face up or down as the case may require. In *north latitude*, when the sun is to the west of the moon, the instrument is held with its face upwards; but when the sun is to the east of the moon, it must be held with its face downwards. In *south latitude* the *opposite* of this rule must be followed. This is often much easier if the observer can hold the sextant in his left hand; the position of the hand and wrist may otherwise be cramped and almost painful. Before taking an observation, look at the sun through the dark shades, and select those which reduce its brightness in the greatest degree compatible with good definition; put these down before the index glass; see that the inverting telescope is adjusted to focus; set the index to zero (0°): and hold the instrument with its plane parallel to a line joining the sun and moon; look at the moon through the telescope collar

and horizon glass, and move the index slowly forward until the sun's reflected image makes a rough contact with the moon, seen by direct vision through the unsilvered part of the horizon glass; clamp the index, screw in the telescope, and make the contact perfect in the centre of the field with the tangent screw, moving the sextant slowly round the axis of the telescope, by which means the reflected image of the sun will appear to pass the moon, and the accuracy of the contact can be tested.

Between the Moon and Star or Planet.—The angular distance between a star or planet and the moon, is always measured to the moon's enlightened limb, which is often the farthest from the star or planet. When this is the case, the moon must be brought by reflection past the star or planet before the contact can be made; in other respects the observation is precisely similar to that already described, when the angular distance of the sun is taken.

In observations of this class, the utmost attention must be paid to accuracy, as, under the most favourable circumstances, 15" error in the observed distance would cause an error of 6' of longitude; and a faulty habit of observation in making contacts of the moon's limb with a star is not necessarily eliminated, as is very generally supposed, and frequently stated, by taking distances east and west of the moon. For example, if

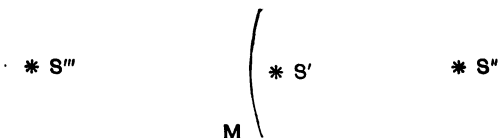

it is an observer's habit, in making a contact, to place the star within the moon's disc, M, as at S', the distance S' S'' is too small, and the distance S''' S'' too great; but supposing the moon to be moving in the direction from S' to S''', each distance will give too early a Greenwich time, for each will give the time when the moon's limb was actually at S'. When, however, the sun is the object observed east and west of the moon, errors of this sort in observation, if constant, will be eliminated, since, as the moon's enlightened limb is always turned towards the sun, such errors would increase both distances and produce errors of an opposite description in the Greenwich time.* A single observation is of little value;

* For further information on this subject, read the article on Lunar Distances in "*Chauvenet's Spherical Astronomy.*"

distances should always be observed in sets. The more nearly the two bodies approach the same horizontal plane, the easier will be the observation to take, and distances between 45° and 90° will be least liable to errors in observation.

Observations for finding the Longitude.

No method is more generally serviceable than *lunars*. They should be made in pairs, with stars *e.* and *w.* of moon, and nearly equidistant from it. Also the thermometer and the barometer (or its equivalent, a boiling-point thermometer) should be noted, and the refraction corrected accordingly: because, if thermometric and barometric corrections be omitted, in observations made on a high and heated plateau, there may be serious errors in the results.

A complete pair of lunars, made wholly by one person, consists of the following observations, *in addition to those for latitude*. It may, however, sometimes happen that the altitudes of one or both the heavenly bodies cannot be observed, in which case they may be computed; but in order to do this, the error of the watch on local mean time must be accurately known; as this, however, greatly increases the amount of computation, the altitudes, should, if possible, always be observed.

An hour before beginning to observe, get everything in perfect order; see that the lamp is well trimmed, its air-holes free, and that it is filled with oil. Also rehearse the expected observations, that no hitch may occur after they have commenced. Then let the hand and eye have ample time to repose, and go on as follows:—

1. Read thermometer in air.
2. Adjust horizon-glass, if necessary.
3. Two pairs of observations for index error.
4. Three altitudes for time, star *e.*
5. Three altitudes for time, star *w.*
6. Three altitudes of moon.
7. Five lunar distances, star *e.* of moon.
8. Five lunar distances, star *w.* of moon.
9. Three altitudes of moon.
10. Three altitudes for time, star *w.*
11. Three altitudes for time, star *e.*

12. Two pairs of observations for index error.
13. Read thermometer in air.
14. Read barometer (or its equivalent, a boiling-point thermometer).

The series A may be repeated over and over again, so long as the eye and hand can be surely depended on.

Absolute longitude may also be determined from altitudes of the moon, occultations of fixed stars, and by the eclipses of Jupiter's satellites. The particulars of these observations are given with the examples.

General Remarks on Observing.—Endeavour with much forethought to *balance* your observations. Whenever you have to take a star's altitude for time east, select and wait, if you are able to do so, for another star as nearly as may be of the same altitude west, and use the same telescope, horizon roof, &c. If a meridian altitude be taken north, choose another star of similar altitude, and take it south; so also with lunars. In this way your observations will be in pairs, and the mean of each pair will tend to be independent of all constant instrumental and refraction errors; and by comparing the means of these pairs, one with another, you will know your skill as an observer, and estimate with great certainty the accuracy that your results have reached. Never rest satisfied with your observations, unless you feel sure that you have gained means of ascertaining the limit beyond which you certainly are not wrong. When you write down your observations, mark them "good," "very good," "doubtful," &c., by their sides.

12. FORMS OF COMPUTATION.

The following are examples of the readiest methods of computing such observations as a traveller may take with a sextant, artificial horizon, and a good watch. The figures in brackets, as (40), refer to the number of the table in "Raper" from which the quantity is taken. It will be of great assistance to the traveller if (before leaving England) he copies the forms of the computations given (omitting the figures), and reproduces blank forms by any one of the many copying processes now in common use; it is in part with this intention, that the notes on the examples are given, as they will serve to remind him of the manner in which the corrections are to be applied.

Latitude by Meridian Altitude.

July 12th, 1882.—At a place in longitude by account 70° 00' W., the meridian altitude of the ☉ was observed in quicksilver, to find the latitude. Ther. 88°. Bar. 29·6 inches. Index error — 2'. Observer south of the ☉.

	H.	M.	S.		°	'	"
Time of App. noon	0	0	0	Alt. ☉ in Quicksilver	114	49	28
W. Long. in Time	+4	40	0	Index error	-	2	00
G. App. Time, July 12th ..	4	40	0		2)114	47	28
Declination (P. I. N.A.) ..	21	57	56·8 N.	Observed Altitude =	57	23	44
Correction	-	1	37·8	Refraction—			
Reduced Declination	21	56	19 N.	Ther. 88°, Bar. 29·6 .. }	-	00	41
			"	Semidiameter	57	23	3
Var. in 1 hour (N.A.)			20·99		+.	15	46
Hours and min. of G. A. T. ..			4·66	Parallax	57	38	49
			12594				7
			12594				
			8396	Zenith Distance	32	21	4 S.
			60)97·8134	Declination	21	56	19 N.
Corr. =	1	37·8		Latitude	10	24	45 S.

July 10th, 1882.—At a place in longitude by account 70° 00' W., the meridian altitude of a *Aquarii* was observed in quicksilver to find the latitude. Ther. 34°. Bar. 30 inches. Index error + 3' 10". Observer south of the star.

	°	'	"
Alt. of * in Quicksilver	90	59	42
Index error	+	3	10
	2)91	2	52
Refraction—Ther. 34°, Bar. 30 ..	45	31	26
True Alt.	45	30	30·8
	90	00	00
Zenith Distance	44	29	29·2 S.
Declination	0	53	13·4 S.
Latitude	45	22	42·6 S.

Latitude by Altitudes of a Star or Planet, near the Meridian.

On April 5th, 1880, the following observations were taken of a *Leonis (Regulus)* when near the meridian, to determine the Latitude, watch being 0 m. 2 sec. slow of G.M.T. Index error 1' 30" minus. Lat. nearly 51° 24' 30" N.; Long. 00° 9' 39" W. The star south of observer.

Times by Watch.		Alt. Art. Hor.		H.	M.	S.
H.	M.	0	"	=	=	=
9	1 25	102	18 40	10	2	1' 57
2	30	19	10	∞	56	39' 27
3	40	19	30	9	5	23' 20
5	4	19	00	=	=	=
6	10	18	25	9	6	∞' 9
5)	18 49	5)	34 45			
Mean .. =	9 3 45' 8	Index	102 18 57 = Mean.	H. <td style="text-align: center;">M. <td style="text-align: center;">S. </td></td>	M. <td style="text-align: center;">S. </td>	S.
Error of Watch	+ 2	error }	- 1 30	∞	56	39' 27
G.M.T. .. =	9 3 47' 8	2)	102 17 27	1	28	47
		Obs. Alt. = 51 8 43' 5		∞	58	8' 72

* ^s 's Right Ascension.	=	10	2	1' 57
Sidereal Time (P. H. N. A.)	=	∞	56	39' 27
April 5th—				
Approximate Time of Transit	=	9	5	23' 20
W. Longitude in Time	=	=	=	=
G. M. T.	=	9	6	∞' 9

Sidereal Time (P. H. N. A.)	H. <td style="text-align: center;">M. <td style="text-align: center;">S. </td></td>	M. <td style="text-align: center;">S. </td>	S.
Acceleration } 6 hours	∞	56	39' 27
for } 1 sec.	1	28	47
Mean ☉'s Corrected R.A.	∞	58	8' 72
* ^s 's R.A.	10	2	1' 57
Time of * ^s 's Transit at Place	=	9	3 52' 85
Longitude in Time	=	+	38' 6
G.M.T. of Transit	=	9	4 31' 45
Error of Watch on G. M. T.	=	-	2
Time by Watch of Transit	=	9	4 29' 45

H. M. S.			
Watch shows 9 4 29 at *'s Transit.			
Watch Times.	Differences. Mean Time.*	Hour Angles. Sidereal Time.	Nos. from Table 49, Paper.
H. M. S.	M. S.	M. S.	
9 1 25	3 4	3 4.5	18.6
9 2 30	1 59	1 59.3	7.7
9 3 40	0 49	1 49.1	1.3
9 5 4	0 35	35.1	0.7
9 6 10	1 41	1 41.2	5.6
			5) 33.9
			N.=6.78

Latitude	..	51	24	30	Cos	9.795022
Declination	..	12	32	57	Cos	9.980466
M. Z. D.	..	38	51	33	Cosec	..	0.202450
N.	Log	..	0.812430
Log. Reduction	6.58				= 0.818198

Observed Altitude	0	1	"
Refraction	51	8	43.5 S.

Reduction	51	7	56.4
Meridian Alt.	51	8	3

Meridian Zenith Dist.	38	51	57 N.
Declination	12	32	57.4 N.
Latitude	51	24	54.4 N.

* The differences of Mean Time (found by taking the difference between Watch Times, and the time of Transit, or Meridian passage, shown by Watch) are reduced to Sidereal Time by the Table of "Time Equivalents," given in the Nautical Almanac.

N.B.—If the object be a Planet, the Declination and Right Ascension must be corrected for the G.D. by the Daily Diff. (Mean Time N. A.)

Longitude by Chronometer, from Altitudes of the Sun.

This observation was taken with a sextant and artificial horizon, P.M. at place :—

Latitude	° ' "	51 31 00 N.		Thermometer.	Barometer.
				43°.	29.8 inches.
1881. Times by Watch.				Original error of Watch	} March 10th
Month. Day.	H. M. S.			Daily Rate	} 34.3 secs. slow.
March 29.	3 37 38			Interval	} 2 secs. gaining.
	3 38 25			Accumulated Rate	} 19 days.
	3 38 55				} 38
	3)10 54 58			Declin. March 29th Page II.	} 0 ' "
Error	= + 34.3			N. A.	} 3 32 48.1 N.
				Hourly Diff.	} + 3 30
Accumulated Rate =	3 38 53.6			Sun's Declin.	} 3 36 18.1 N.
G. D. March 29	3 38 15.6			Polar Dist.	} 86 23 41.9
	3)148 5 50			Eq. Time, Page II. N.A.	} M. S.
				Hourly Diff.	} 4 45
				Rect. Eq. Time + to App. Time =	} 4 42.3

* When great exactness is required, note Ther. and Bar., and correct Refraction by Tables 32 and 33 of Raper, or by any similar table.

If the Watch is right for Apparent Time, }
 it will show } 12 0 0
 But it shows } 12 8 23.9
 Therefore it is Fast for App. Time at Place 8 23.9

Applying Equation of Time to } 12 0 0
 Equation of Time } + 8 5.8
 If right for M. T., at App. Noon the Watch } 12 8 5.8
 would show }
 But it shows } 12 8 23.9
 Therefore Watch Fast on M. T. at Place .. 18.1

Applying Long. in Time to M. T. at App. } 12 8 5.8
 Noon }
 Longitude in Time } 32.8
 Corresponding G. M. T. } 12 8 38.4
 But Watch shows } 12 8 23.9
 Watch Slow on G. M. T. at Apparent Noon 14.5

* + when ☉'s P. D. is increasing, but - when ☉'s P. D. is decreasing.

C 112'''.6
 Lat. .. 31° 30' 40''
 h 1h. 54m. 31s. 6
 Log. .. 2.051438
 Tang. .. 0.099567
 Cosec. .. 0.319481
 To find A.
 A. 295'''.5
 Log. = 2.470586

C 112'''.6
 Decl. .. 0° 46' 30'''.4
 h 1h. 54m. 31s. 6
 Log. .. 2.051538
 Tang. .. 8.131206
 Cotang. .. 0.262829
 To find B.
 B. 2'''.79
 Log. = 0.445573

A + B, when the Lat. and Decl. are contrary names; and
 A - B when they are the same name, is the Equation of Equal
 Altitudes. Divide this Equation by 15, and the result is the
 Equation expressed in time.

Middle Time by Watch H. M. S.
 *Equation of Equal Altitude 12 8 43.8
 Time by Watch at Apparent Noon 12 8 23.93

64 To find the Error of a Watch by Equal Altitudes of a Fixed Star.

1. Take the mean between the times shown by the chronometer when the star has Equal Altitudes east and west of the meridian, and the time thus found will be the time by *chronometer* when the star passes the meridian.

2. Take the star's Right Ascension from the 'Nautical Almanac,' for the day nearest to the given date.

3. Take the *Sidereal Time* from page ii. 'Nautical Almanac,' of the month for the given day.

4. Subtract the Sidereal Time from the star's Right Ascension, *increasing* the latter by 24 hours *if necessary*, and the remainder is the Mean Time (nearly) of the star's transit at the given meridian.

5. Write the day of the month before the hours, &c., and add the Longitude in Time, if West, or subtract, if East, and the sum or remainder is the Greenwich Date of the meridian passage of the star (nearly).

Then, To find the time of Meridian Passage more accurately:—

6. Take the Sidereal Time again as directed in 3, and accelerate it for the *Greenwich Date* (found as directed by 5), and the result will be the *corrected* mean sun's Right Ascension.

7. The difference between the time by chronometer when the star passes the meridian (as found by rule 1) and the *corrected* mean sun's Right Ascension (as found by rule 6) will be the error of the chronometer.

Example.—On August 10th, 1879, in Lat. $51^{\circ} 22' N.$, Long. $00^{\circ} 10' W.$, Equal Altitudes of the star α *Cygni* were taken, when the watch showed as undermentioned; required the error for Mean Time at the place of observation when the star passed the meridian:—

Watch Times of Equal Altitudes.			
	H.	M.	S.
α <i>Cygni</i> E. of Meridian	8	45	10
" W. "	13	20	15
	<hr/>		
	2)	22	5 25
	<hr/>		
Time by Watch, of Star's Transit	11	2	42.5

To Find Time of Star's Transit.					
	Month.	Day.	H.	M.	S.
Star's R. A.	August	10th	20	37	21.98
Sidereal Time, p. ii. N. A.	"	"	9	14	22.59
	<hr/>				
Time of Star's Transit at Place (nearly)			11	22	59.39
Longitude in Time $10' W.$					+ 40
	<hr/>				
Greenwich Date of Star's Transit (nearly)	11	23	39.39		

Mean Sun's R. A.

	Month.	Day.	H.	M.	S.
Sidereal Time, p. ii. N. A., August 10th	9	14	22.59		
Acceleration { 11 h.			+ 1	48.42	
for G. D. of { 23 m.			+ 3.78		
transit (23) { 39 sec.			+ 0.11		
	<hr/>				
Mean \odot 's R. A. corrected	9	16	14.90		

To Find Error of Watch.

	Month.	Day.	H.	M.	S.
Star's R. A. . . August 10th	20	37	21.98		
Corrected Mean {			9	16	14.9
\odot 's R. A. }	"	"			
	<hr/>				
Corrected Date of Star's Transit at Place	11	21	7.08		

	H.	M.	S.
Therefore Watch should show	11	21	7.08
But it shows	11	2	42.5

Error of Watch for Mean Time at *place* when Star passed Meridian } = 00 18 24.58 slow.

To find the True Bearing of a peak or any other object by means of its observed angular distance from the sun.

Observe the sun's altitude, then the angles between the object and the nearer and farther limbs, and lastly the sun's altitude again; noting the times of each contact. If the object has any altitude observe it, and note whether it is east or west of the sun. Half the sum of the times of the observed distances is the mean time of the observation, and half the sum of the distances observed is the apparent distance; but if the farther limb, only, be observed, the apparent distance is found by subtracting the sun's semi-diameter; or if the nearer limb, by adding. From the observed altitudes of the sun, the altitude at the time of the observed distance is found by simple Rule of Three.

With time at place find Greenwich date, either by the error and rate of the watch, or with the Longitude in time.

Take the declination from the 'Nautical Almanac' (if *App.* time is used, Page I.; if *Mean* time, Page II.); correct this for the Greenwich date. From the observed altitude, find the *True Alt.*

Add together $\left\{ \begin{array}{l} \textit{True Altitude,} \\ \textit{Latitude,} \\ \textit{Polar Distance;} \end{array} \right.$

divide their sum by 2 for the half sum, and take the difference between the Polar Distance and the half sum, which call remainder.

Add together $\left\{ \begin{array}{l} \textit{Log secant of the Alt.,} \\ \textit{Log secant of the Latitude,} \\ \textit{Log cosine of } \frac{1}{2} \textit{ sum,} \\ \textit{Log cosine of remainder.} \end{array} \right. \text{ rejecting 30 from the index.}$

Take out the Log sine square of the sum of these four Logs (*table 69 Raper*), or divide the sum by 2, and it will give the Log sine of half the True Azimuth, which multiply by 2; in either case the result will be the sun's true bearing. If the observed object has an altitude

Add together $\left\{ \begin{array}{l} \textit{Log sine of object's alt.,} \\ \textit{Log sine of } \odot \textit{'s app. alt.,} \\ \textit{Log cosec of app. distance,} \end{array} \right. \text{ dropping 20.}$

and take out the sum as a Log sine: the result is the corrected distance.

If the observed object has no altitude, or if its altitude is very small,

this step is neglected, and the apparent distance is used as the corrected distance.

Find the Apparent Alt. from the True Alt. already found, from the observed angular distance find the Apparent Distance, and from the Cos of the dist. from ☉'s centre, subtract the Cos of the Apparent Altitude, the remainder will be the Cosine of difference of bearings. If the sun be *East* of the meridian, and the object more *East*, or the sun be *West*, and the object more *West*, *add* the difference of bearing thus found, to the ☉'s true bearing. In any other case, take the difference between the sun's true bearing, and the difference of bearings, and the result is the true bearing of the object.

Example.

$$\text{Cos (difference of bearings)} = \frac{\text{Cos (apparent distance)}}{\text{Cos (apparent alt. of } \odot)}$$

Observation: July 15th, 1881, P.M. at Place, Angles and Altitudes taken with a sextant. Lat. 51° 24' N. Long. 9° 39' W.

Time.	☉ Alt. in Quicksilver.	Obsd. Angular distance of an
H. M. S.	" "	object.
<u>3 13 18</u>	<u>87 45 00</u>	East of the Sun 109 12 10

Year. Month. Day.	H. M. S.
1881, July 15 ..	3 13 18
Error of Watch.. ..	- 13
Month. Day.	
G. M. T. July 15 ..	<u>3 13 5</u>

Month. Day.	° ' "
Declination July 15th (Page II. N. A.)	21 28 52 N.
Correction by Hourly Diff. for G. M. T.	- 1 17

	° ' "
Obsd. Alt. in Quicksilver ☉	87 45 00
Index Error	- 2 10
	<u>2) 87 42 50</u>
Obsd. Alt. =	43 51 25
Refraction	- 1 0
	<u>43 50 25</u>
Semidiam.	+ 15 46
	<u>44 6 11</u>
Parallax	+ 6
True Alt.	<u>44 6 17</u>

Polar Dist. =	68 32 25
-----------------------	----------

	° ' "	
☉'s True Altitude	44 6 17	Sec. 0° 143834
Latitude	51 24 00	Sec. 0° 204899
Polar Distance ..	68 32 25	
	<u>2) 164 2 42</u>	
½ Sum =	82 1 21	Cos. 9° 142341
½ Sum ~ P. Dist. . .	13 28 56	Cos. 9° 987863

☉'s True Bearing = Log. Sin. Square (69) }
 = S. 66° 34' 45" W. } 9° 478937

	° ' "
Obsd. Alt. ☉	43 51 25
Semidiam.	+ 15 46
Apparent Alt. ☉	<u>44 7 11</u>

If the ☉ be East of the meridian and the object more East, or the ☉ West and the object more West, *add* the difference of the bearings to the ☉'s True bearing. In any other case take the difference, and the result is True bearing of object.

Observed angular distance of object from the near limb	}	109	10	00					
of the sun, corrected for Index error									
☉'s Semidiam.			+	15	46				
Distance from ☉'s centre				109	25	46	Cos.		9° 52' 19.8"
☉'s Apparent Altitude				44	7	11	Cos.		9° 8' 56.056"
Difference of Bearings				62	18	24	= Cos.		9° 66' 59.27"
Difference of Bearings*	=	62	24				True Bearing of ☉	S.	66 35 W.
		180	00				Object East of ☉		117 36
(* If the obsd. angular distance is greater than 90°, subtract this Difference of Bearings from 180°.)		117	36				True Bearing of Object	S.	51 1 E.

Clearing the Lunar Distance by Raper's Rigorous Method.

As this is one of the shortest, and at the same time a strictly accurate method of clearing the Lunar Distance, it is here given for the benefit of those travellers who may not have Raper's work in their possession.

Having found the Greenwich date with the assumed longitude in time, and the mean time at place by a watch, the error of which on local time has been found by previous observation, reduce thereto the moon's horizontal parallax and semidiameter, and if the sun be one of the objects observed, take its semidiameter from the 'Nautical Almanac.' From the observed altitudes get the apparent and true altitudes; from the observed distance get the apparent distance. Add to, or subtract from the apparent altitudes as many seconds as are necessary to bring them to odd or even minutes, then add them together and subtract their sum from 180°, and the remainder will be the sum of the Apparent Zenith Distances.

Increase or diminish the True Altitudes by the same number of seconds as were added to or subtracted from their respective Apparent Altitudes; add them together and subtract their sum from 180°, and the remainder will be the sum of the True Zenith Distances.

Add together the Log-secants of the Apparent Altitudes and the Log-cosines of the True Altitudes; the sum, rejecting tens in the index, will be the *Logarithmic Difference*.

Increase or diminish the Apparent Distance by any quantity of seconds necessary to bring it to an odd or even minute (noting the number of seconds); to this add the sum of the Apparent Zenith Distances; take Half the Sum, and from this Half Sum subtract the Apparent Distance—call this Remainder.

To the Log sines of the *Half Sum* and Remainder add the Logarithmic Difference, and the sum, rejecting tens in the index, will be the Log sine square of the auxiliary arc x .

Note.—This arc may also be found without any special table of log sines square in the following manner:—When the sum of these three logs has for an index a number above 20, reject 10 from such index, and then divide the sum by 2; this will give $\frac{1}{2}$ the log sine of the arc, which multiplied by 2 will give auxiliary arc x ; *this, of course, applies to all cases where a log sine square is mentioned.*

Under x put the sum of the True Zenith Distances, take their sum and difference and their Half Sum and Half Difference, add together the log sines of the Half Sum and Half Difference, and their sum is the log sine square of an arc, to apply the same number of seconds by which the Apparent Distance was increased or diminished to bring it to an odd or even minute, subtracting them if the Apparent Distance was increased, but adding them if diminished, and the result will be the true distance nearly. Take the difference between the proportional logs in the 'Nautical Almanac' against the two distances between which the computed true distance falls. With this difference and the portion of time just found, enter the table of Corrections for second differences ('Nautical Almanac' or 57 Raper), and take out the seconds. When the proportional logs in the 'Nautical Almanac' are *increasing*, subtract these seconds from the True Dist., nearly; when they are *decreasing* add them; the result will be the M.T. at Greenwich.

Mars (+13' 5'')	40 11 00	Mars (+13' 5'')	40 10 3' 9
D's (+19' 8'')	39 31 00	D's (+19' 8'')	40 12 24 8
Sum =	79 42 00	Sum	80 22 28' 7
	180 00 00		180 00 00
Apparent Zenith } Dists ..	100 18 00	True Zenith } Dists ..	99 37 31' 3

Mars App. Alt.	Sec.	0' 11 69 16
D's App. Alt.	Sec.	0' 11 26 98
Mars True Alt.	Cos	9' 88 31 84
D's True Alt.	Cos	9' 88 29 33
Logarithmic Difference		= 9' 99 57 31

Mars True Alt.	0	1	''
Lat.	40	9	50
P.D.	51	31	11
	72	31	37
Sum	2)	164	12 38
† Sum	82	6	19
† Sum - Alt.	41	56	29
			
Hour	H.	M.	S.
Mars RA + 24 hours	3	5	16 = Log Sin sq. = 9' 189 411
	20	56	15

App. Dist.	0	1	''
App. Zenith Dista.	53	17	00
Sum	2)	153	35 00
† Sum	76	47	30
† Sum - App. Dist.	23	30	30
Logarithmic difference			
Arc z	76	38	52 = { Sin. } = 9' 58 49 32
True Zenith Dista.	99	37	31' 3
Sum	176	16	23' 3
Difference	22	58	39' 3
† Sum	88	8	11' 6
† Difference	11	29	19' 6
Approx. True Dist.	52°	59'	50'' = { Sin. } = 9' 299 013
Seconds added			1' 7
True Dist.	52	59	48' 3
N.A. at VI. hours	53	55	19 pro Log. N.A. 2805
Difference	55	30' 7	pro Log. (74) 5109
Time of Dist. by N.A.	H.	M.	S.
	6	00	00
	1	45	54 = pro Log = 2304

Correction for 2nd } difference (57)	7 45 54	4
G. M. T. by Lunar	7 45 50	
Time by Watch	7 46 33	
Watch fast of G. M. T.	= 43	
Long. in Time	= 00 8 00 West.	

Lunar (Raper's Rigorous Method)

Latitude ..	° ' "	51 31 11 N.
Thermometer ..		49
Barometer ..		30 inches.

Date November 22nd, 1879, P.M. at place of observation, Mars and ♃, Mars East of Meridian.

	H. M. S.								
Time by Watch ..	7 46	33							
Accumulated Rate of Watch ..	-	29							
Error of Watch ..	7 46	4							
G. M. T. Nov. 22nd ..	7 45	56							
Supposed									
♃ Semid. (table 40) ..	15	2 1/2							
Augmentation (42) ..	9 1/2								
♃'s Aug. Semid ..	15	11 1/7							
Mar's Declination ..	17 28	23 N.							
Mar's Polar Dist. ..	72 31	37							
Mar's R.A. ..	2 56	15							
Art. Hor.									
Mars, Observed Alt. 80 ..	21	30							
Index error ..	+	78 30	54						
2) 80 21 33									
App. Alt. ..	40 10	46 1/2							
Refraction - 1' 9 1/2" ..	0	56 1							
Par. in Alt. + 13" ..	-	40 9	50 4						
Mars True Alt. ..	40 9	50 4							
♃'s True Alt. ..									
= 40 12	5 2								
♃'s App. Alt. ..									
= 53 32	10								
♃'s Semid. Augmented ..									
= 53 16	58 3								
♃'s Apparent Dist. ..									
= 53 16	58 3								
♃'s True Alt. ..									
= 53 32	10								
♃'s Apparent Dist. ..									
= 53 16	58 3								

	O ' "								
♃'s Hor. Par. Noon ..									
Mid... ..									
Variation in 12 hours ..									
Correction (table 21) ..									
Hor. Par. Noon ..									
Hor. Par. corr. for G.D. ..									
Corr. for Lat. (41) ..									
Reduced Hor. Par. ..									
Day.									
Sidereal Time at Mean Noon Nov. 22nd ..	16 4	24 24							
Acceleration for G.D. (23) ..	7	hours ..	1	9					
	45	min. ..	7	39					
	56	sec. ..	15						
Mean ☉'s R.A. ...									
= 16 5	40 78								
Observed Distance F.L. ..									
= 53 30	10								
Index error ..									
+ 2	00								
♃'s Semid. Augmented ..									
= 53 32	10								
♃'s Apparent Dist. ..									
= 53 16	58 3								

Mars (+13.5'')	40	11	00	True Alts.	0	1	11
D's (+19.8'')	39	31	00	Mars (+13.5'')	40	10	3.9
Sum =	79	42	00	D's (+19.8'')	40	12	24.8
Apparent Zenith	100	18	00	Sum	80	22	28.7
Dists ..	180	00	00	True Zenith	180	00	00
				Dists ..	99	37	31.3

Mars App. Alt.	Sec.	0.116016
D's App. Alt.	Sec.	0.112608
Mars True Alt.	Cos	9.883184
D's True Alt.	Cos	9.882933
Logarithmic Difference		9.995731

Mars True Alt.	0	1	11	
Lat.	40	9	50	
P.D.	51	31	11	
Sum	72	31	37	
	2)	164	12	38
† Sum	82	6	19	
† Sum - Alt.	41	56	29	
Hour	H. M. S.			
Mars RA + 24 hours	3	5	16	
	25	56	15	

Log Sin sq.	=	9.180411
R. A. of Merid.	=	23 50 59
Mean Sun's R. A.	=	16 5 41
Mean Time at Place.	=	7 45 18
G. M. T. by Lunar.	=	7 45 50
Long. in Time	=	00 00 32

App. Dist.	0	1	11
App. Zenith Dists.	53	17	00
Sum	2)153	35	00
† Sum =	76	47	30
† Sum - App. Dist.	=	23	30	30		
Logarithmic difference	Sin.	9.088356	
	Sin.	9.60845	
		9.995731	

Arc z	76	38	52
True Zenith Dists.	99	37	31.3
Sum	176	16	23.3
Difference	22	58	39.3
† Sum	88	8	11.6
† Difference	11	29	19.6

Approx. True Dist.	52°	59'	50"
Seconds added	-	-	1.7
True Dist.	52	59	48.3
N.A. at VI. hours	53	55	19
Difference	55	30.7	pro Log. (74) 5109

Time of Dist. by N.A.	H. M. S.		
	6	00	00
	1	45	54
Correction for 2nd difference (57)	7	45	54
G. M. T. by Lunar	7	45	50
Time by Watch	7	46	33
Watch fast of G. M. T.	=	43	
"	=	8	00
West.			

To clear the Lunar Distance by Natural Cosines.

Take the sum and difference of the apparent altitudes; also the sum and difference of the true altitudes. When the sum of the altitudes is less than 90° , add together the natural cosines (Table XVI.) of the sum and difference of the apparent altitudes; also the natural cosines of the sum and difference of the true altitudes.

When the distance is less than 90° , add together the Nat. Cosine of the sum of the App. Alts. and the Nat. Cosine of the App. Dist. When the Dist. is greater than 90° take their difference, multiply this result by the sum of the Nat. Cosines of the true alts., and divide the product by the sum of the Nat. Cosines of the App. Alts.: the result will be a quantity which call x ; the difference between x and the Nat. Cosine of the sum of the true alts. will be the Nat. Cosine of the true distance when it is less than 90° , but when greater than 90° , deduct it from 180° , and the result will be the true distance.

When the sum of the Altitudes is greater than 90° , instead of the sums of the natural cosines, of the sums and differences of the true and app. alts., take their differences; x is found as before, and is to be added to the nat. cosine of the sum of the true alts., and the result will be the nat. cosine of the true dist.

<table style="width: 100%; border-collapse: collapse;"> <tr> <td style="width: 15%;">Mars App. Alt.</td> <td style="width: 15%; text-align: right;">40</td> <td style="width: 15%; text-align: right;">11</td> <td style="width: 15%; text-align: right;">00</td> <td style="width: 15%;"></td> <td style="width: 15%;"></td> </tr> <tr> <td>J's App. Alt.</td> <td style="text-align: right;">39</td> <td style="text-align: right;">31</td> <td style="text-align: right;">00</td> <td></td> <td></td> </tr> <tr> <td style="text-align: right;">Sum =</td> <td style="text-align: right; border-top: 1px solid black;">79</td> <td style="text-align: right; border-top: 1px solid black;">42</td> <td style="text-align: right; border-top: 1px solid black;">00</td> <td></td> <td></td> </tr> <tr> <td style="text-align: right;">Difference =</td> <td style="text-align: right; border-top: 1px solid black;">00</td> <td style="text-align: right; border-top: 1px solid black;">40</td> <td style="text-align: right; border-top: 1px solid black;">00</td> <td></td> <td></td> </tr> </table>	Mars App. Alt.	40	11	00			J's App. Alt.	39	31	00			Sum =	79	42	00			Difference =	00	40	00			<table style="width: 100%; border-collapse: collapse;"> <tr> <td style="width: 15%;">Mars True Alt.</td> <td style="width: 15%; text-align: right;">40</td> <td style="width: 15%; text-align: right;">10</td> <td style="width: 15%; text-align: right;">04</td> <td style="width: 15%;"></td> <td style="width: 15%;"></td> </tr> <tr> <td>J's True Alt.</td> <td style="text-align: right;">40</td> <td style="text-align: right;">12</td> <td style="text-align: right;">25</td> <td></td> <td></td> </tr> <tr> <td style="text-align: right;">Sum =</td> <td style="text-align: right; border-top: 1px solid black;">80</td> <td style="text-align: right; border-top: 1px solid black;">22</td> <td style="text-align: right; border-top: 1px solid black;">29</td> <td></td> <td></td> </tr> <tr> <td style="text-align: right;">Difference =</td> <td style="text-align: right; border-top: 1px solid black;">2</td> <td style="text-align: right; border-top: 1px solid black;">21</td> <td style="text-align: right; border-top: 1px solid black;"></td> <td></td> <td></td> </tr> </table>	Mars True Alt.	40	10	04			J's True Alt.	40	12	25			Sum =	80	22	29			Difference =	2	21			
Mars App. Alt.	40	11	00																																														
J's App. Alt.	39	31	00																																														
Sum =	79	42	00																																														
Difference =	00	40	00																																														
Mars True Alt.	40	10	04																																														
J's True Alt.	40	12	25																																														
Sum =	80	22	29																																														
Difference =	2	21																																															
<table style="width: 100%; border-collapse: collapse;"> <tr> <td style="width: 15%;"></td> <td style="width: 15%; text-align: right;">79</td> <td style="width: 15%; text-align: right;">42</td> <td style="width: 15%; text-align: right;">00</td> <td style="width: 15%;"></td> <td style="width: 15%;"></td> </tr> <tr> <td>Sum of App. Alts.</td> <td style="text-align: right;">00</td> <td style="text-align: right;">40</td> <td style="text-align: right;">00</td> <td></td> <td></td> </tr> <tr> <td>Diff. of App. Alts.</td> <td></td> <td></td> <td></td> <td style="text-align: right;">79</td> <td style="text-align: right;">42</td> </tr> <tr> <td></td> <td></td> <td></td> <td></td> <td style="text-align: right;">00</td> <td style="text-align: right;">40</td> </tr> </table>		79	42	00			Sum of App. Alts.	00	40	00			Diff. of App. Alts.				79	42					00	40	<table style="width: 100%; border-collapse: collapse;"> <tr> <td style="width: 15%;">Nat. Cosine =</td> <td style="width: 15%;"></td> <td style="width: 15%;"></td> <td style="width: 15%; text-align: right;">.178802</td> <td style="width: 15%;"></td> <td style="width: 15%;"></td> </tr> <tr> <td>Nat. Cosine =</td> <td></td> <td></td> <td style="text-align: right;">.999932</td> <td></td> <td></td> </tr> <tr> <td>(1st Term) =</td> <td></td> <td></td> <td style="text-align: right; border-top: 1px solid black;">1.178734</td> <td></td> <td></td> </tr> </table>	Nat. Cosine =			.178802			Nat. Cosine =			.999932			(1st Term) =			1.178734								
	79	42	00																																														
Sum of App. Alts.	00	40	00																																														
Diff. of App. Alts.				79	42																																												
				00	40																																												
Nat. Cosine =			.178802																																														
Nat. Cosine =			.999932																																														
(1st Term) =			1.178734																																														
<table style="width: 100%; border-collapse: collapse;"> <tr> <td style="width: 15%;"></td> <td style="width: 15%; text-align: right;">80</td> <td style="width: 15%; text-align: right;">22</td> <td style="width: 15%; text-align: right;">29</td> <td style="width: 15%;"></td> <td style="width: 15%;"></td> </tr> <tr> <td>Sum of True Alts.</td> <td style="text-align: right;">00</td> <td style="text-align: right;">2</td> <td style="text-align: right;">21</td> <td></td> <td></td> </tr> <tr> <td>Diff. of True Alts.</td> <td></td> <td></td> <td></td> <td style="text-align: right;">80</td> <td style="text-align: right;">22</td> </tr> <tr> <td></td> <td></td> <td></td> <td></td> <td style="text-align: right;">00</td> <td style="text-align: right;">2</td> </tr> </table>		80	22	29			Sum of True Alts.	00	2	21			Diff. of True Alts.				80	22					00	2	<table style="width: 100%; border-collapse: collapse;"> <tr> <td style="width: 15%;">Nat. Cosine =</td> <td style="width: 15%;"></td> <td style="width: 15%;"></td> <td style="width: 15%; text-align: right;">.167204</td> <td style="width: 15%;"></td> <td style="width: 15%;"></td> </tr> <tr> <td>Nat. Cosine =</td> <td></td> <td></td> <td style="text-align: right;">.999999</td> <td></td> <td></td> </tr> <tr> <td>(2nd Term) =</td> <td></td> <td></td> <td style="text-align: right; border-top: 1px solid black;">1.167203</td> <td></td> <td></td> </tr> </table>	Nat. Cosine =			.167204			Nat. Cosine =			.999999			(2nd Term) =			1.167203								
	80	22	29																																														
Sum of True Alts.	00	2	21																																														
Diff. of True Alts.				80	22																																												
				00	2																																												
Nat. Cosine =			.167204																																														
Nat. Cosine =			.999999																																														
(2nd Term) =			1.167203																																														
<table style="width: 100%; border-collapse: collapse;"> <tr> <td style="width: 15%;">Sum of App. Alts.</td> <td style="width: 15%;"></td> <td style="width: 15%;"></td> <td style="width: 15%; text-align: right;">.178802</td> <td style="width: 15%;"></td> <td style="width: 15%;"></td> </tr> <tr> <td>App. Dist. .. 53^o 16' 58"</td> <td></td> <td></td> <td style="text-align: right; border-top: 1px solid black;">.597865</td> <td></td> <td></td> </tr> <tr> <td>(3rd Term) =</td> <td></td> <td></td> <td style="text-align: right; border-top: 1px solid black;">.776667</td> <td></td> <td></td> </tr> </table>	Sum of App. Alts.			.178802			App. Dist. .. 53 ^o 16' 58"			.597865			(3rd Term) =			.776667			<p style="text-align: center;">1.178734 : 1.167203 :: .776667 : .769069 = x</p> <table style="width: 100%; border-collapse: collapse;"> <tr> <td style="width: 15%;">Sum True Alts. Nat. Cosine =</td> <td style="width: 15%;"></td> <td style="width: 15%;"></td> <td style="width: 15%; text-align: right;">.167204</td> <td style="width: 15%;"></td> <td style="width: 15%;"></td> </tr> <tr> <td>x =</td> <td></td> <td></td> <td style="text-align: right; border-top: 1px solid black;">.769069</td> <td></td> <td></td> </tr> <tr> <td></td> <td></td> <td></td> <td style="text-align: right; border-top: 1px solid black;">.601865</td> <td></td> <td></td> </tr> </table>	Sum True Alts. Nat. Cosine =			.167204			x =			.769069						.601865														
Sum of App. Alts.			.178802																																														
App. Dist. .. 53 ^o 16' 58"			.597865																																														
(3rd Term) =			.776667																																														
Sum True Alts. Nat. Cosine =			.167204																																														
x =			.769069																																														
			.601865																																														
			0	52	59																																												
True Distance ..				52	59																																												

Clearing the Lunar Distance Graphically.

The true distance can also be found approximately with the compasses, and the scale of chords, by the following rule. The letters referred to are those shown in the example (p. 74), where the same distance, &c., as given in the two previous examples are used in the projection.

With the compasses take 60° from the scale of chords, and describe the semicircle DBC , and on the diameter CD erect the perpendicular AB ; mark it D . On the right hand side of this line from B to S , lay off the apparent distance between the two bodies, taken from the same scale of chords. Subtract the moon's apparent altitude from 90° , and, taking the result in the compasses as measured from the scale of chords, set off this distance on each side of B to x and y .

Subtract the sun's, star's, or planet's altitude from 90° , and, taking the result in the compasses, as measured from the scale of chords, set this distance off on each side of S to S' and S'' . Draw the lines xy and $s's''$, marking the point of their intersection E ; then is DE the line of correction, which measure from the scale of chords, if the line $s's''$ intersect the line xy to the right of the line AB , the correction is subtractive; but if to the left, it is additive.

Multiply the line of correction by the horizontal parallax, expressed in minutes and decimals of a minute (as regards the seconds), and divide the product by 62 when the correction is subtractive; but when additive, divide by 53; the result in either case is the correction to be applied to the apparent distance to get the true distance. This projection will, in all suitable cases, give a close approximate to the results of rigorous computation (in the present example within $1''$), but it will be well to bear in mind that altitudes taken either too near the horizon or the zenith are, for various reasons, most liable to error. This remark applies, however, to all methods alike. The chief use of this method is that it serves a check on computation. Great care must be taken to measure accurately with the compasses. A little practice will enable any one, accustomed to use the compasses and scales, to clear a lunar distance in a very short space of time. When the distance is greater than 90° it will not be advisable to use this method.

Rule.—Having taken from the ‘Nautical Almanac’ the Declination, R.A., Sidereal Time, Semidiameter, Horizontal Parallax, &c., as required, correct the same for the *approximate* Greenwich Date.

Find the Hour Angle as follows:—

For the ☉ the apparent time from Noon is the Hour Angle (if P.M. the mean time at place converted into app. time with the equation of time will be the hour angle), but if A.M. the apparent time thus found, expressed astronomically, must be subtracted from 24 hours to give the hour angle.

For the Moon, Star, or a Planet:—

To the Sidereal time at noon on the given day (page ii. N.A.) accelerated for Greenwich Date (table 23 Raper) add the mean time at place, this sum will be the Right Ascension of the Meridian; subtract from the R.A. of the Meridian the R.A. of the object, and the result will be the west hour angle of the object; which subtract from 24 hours when the east hour angle is required.

The True Altitude may now be computed as follows:—

To find arc I.—To the log cosine of the object’s hour angle add the log cotangent of the latitude; their sum (rejecting 10 in the index) will be the log tangent of arc I.

To find the true Altitude.—Add together the log sine of the Latitude, the log secant of arc I., and the log cosine of the *difference* of arc I. and the Polar Dist.; their sum will be the log sine of the true Alt.

N.B.—When the hour angle is more than 6 hours, or 90° , take the log cosine of the *sum* of arc I. and the Polar Dist.

From the True Altitude to find the Apparent Altitude:—

The corrections must be applied in reverse order, and with contrary signs to those with which the true is derived from the Apparent Altitude.

For the Sun or for a Planet.—Subtract the Parallax in Altitude, and add the Refraction.

For a Star.—Add Réfraction.

For the Moon.—Take out the correction in Alt (table 39 Raper), and subtract it from the True Altitude of the Moon, this gives *only* the approximate apparent altitude; enter the same table 39 again with this approximate apparent altitude, and take out the correction again, which subtract from the *TRUE altitude*—the result gives the Apparent Alt.

FORMS OF COMPUTATION.

For \mathcal{D} 's Correction in Altitude (XXXIX. Paper),

$71^{\circ} 10'$ and $59'$	$\equiv 18 \ 43$
$4''$	$\equiv -4$
$8''$	$\equiv +3$
	$18 \ 42$

Thermometer	$73^{\circ} - 0.8$	$\}$	$+ 2.6$
Barometer	$27.4 - 1.8$		
\mathcal{D} 's 1st correction			$\equiv 18 \ 44.6$

\mathcal{D} 's True Alt.	$\equiv 71 \ 14 \ 34$	
1st Correction	$\equiv -18 \ 44.6$	
\mathcal{D} 's Approx. App. Alt.		$\equiv 70 \ 55 \ 49.4$

$70 \ 50$ and 59	$\equiv 19 \ 2$		
$5''$	$\equiv +5$		
$8''$	$\equiv +3$		
	$19 \ 00$		
Thermometer	$73^{\circ} - 0.8$	$\}$	$+ 2.6$
Barometer	$27.4 - 1.8$		
\mathcal{D} 's correction			$\equiv 19 \ 2.6$

\mathcal{D} 's Hour \angle	$1 \ 10 \ 19.41$	Cosine \equiv	9.979220
Latitude	$8 \ 48 \ 00$	Cotang \equiv	10.810206
Arc (1)	$80 \ 46 \ 33$	Tang \equiv	10.789426

Latitude	$8 \ 48 \ 00$	Sin. \equiv	9.184651
Arc (1)	$80 \ 46 \ 33$	Sec. \equiv	0.795073
P. D. - Arc (1)	$7 \ 11 \ 11$	Cosine \equiv	9.996575

\mathcal{D} 's True Central Alt.	$71 \ 14 \ 34$	\equiv	9.976299
\mathcal{D} 's Corr. in Alt.	$-19 \ 2.6$		
\mathcal{D} 's Appr. Altitude	$70 \ 55 \ 33.4$		

To find the Longitude by the Moon's Altitude.

To compute the Moon's Right Ascension at the time and place when its Altitude is observed in an Artificial Horizon, and to deduce therefrom Greenwich Mean Time and the Longitude of the place.

The Observation.—Determine accurately the error of the watch on mean time at place of observation, in the usual manner, by the observed Altitude of the Sun, Star, or Planet; this observation should be taken when the heavenly body is more than three hours from the meridian, and as shortly before the observation for Longitude is taken as possible. The error of the watch on M.T. at place being thus *accurately* determined, observe the Altitude of the upper or lower limb of the D (whichever is the perfect limb) in the Artificial Horizon, and note the time. The nearer the D is to the East or West point of the Horizon, the better, so long as its Altitude is sufficient to permit of its being observed in the Artificial Horizon. When the D is within three hours of the meridian this observation should not be taken.

Note the state of the Thermometer and Barometer, and take the index error of the sextant, both before and after the observation.

It will always be better to take a set of sights, say 3 or 5, than to trust to a single observation; and throughout the computation *extreme accuracy is indispensable.*

Rule.—To compute the D 's Right Ascension :—

To the mean of the times of observation apply the error of the watch on mean time at place (always reckoned from the previous noon) and the Longitude in time (the Longitude must be assumed); the result will be the approximate Greenwich date, to which reduce the D 's semid. (Art. 588 Raper and table 42), the D 's Horizontal Parallax (Art. 587 Raper), the D 's declination (Art. 590 Raper), and with this reduced declination find the Polar Dist. Find the Sidereal time at Place (Art. 608 Raper). Find the D 's true central altitude (Art. 655 Raper), *always, when the Artificial Horizon is used, first applying the index error of the sextant to the mean of the altitudes, and dividing this result by 2 for the observed Altitude.* Then proceed to find the D 's hour angle (or meridian distance) (Art. 614 Raper). To the hour angle thus found, add the sidereal

time at place, and, if the sum exceed 24 hours, diminish it by 24 hours, and the sum will be the computed R.A. of the moon at the time and place of observation, *when the observation has been taken to the east of the meridian*; but, *when the observation has been taken to the west of the meridian*, the hour angle must be subtracted from sidereal time at place (increased if necessary by 24 hours), and the remainder will be the computed Right Ascension of the moon at the time and place of observation.

To find the G.M.T. corresponding to the computed R.A. of the moon:—

With the computed δ 's R.A. enter the 'Nautical Almanac' (pages v. to xii. of each month) on the given day, and take out the next less and the next greater R.A. of the δ (these are given for every hour). Take the diff. between the next less R.A. and the computed R.A., also between the next less R.A. and the next greater R.A. (those taken from the 'Nautical Almanac'). Then to the constant Log 0.4771 add the proportional log of the diff. between the computed and the next less R.A., and from this sum subtract the proportional log of the diff. between the next less and the next greater R.A., and the result will be the proportional log of a portion of time, *always* to be added to the hour given in the 'Nautical Almanac' for the next less R.A., and their sum will be the Greenwich mean time corresponding to the computed δ 's R.A., and, therefore, the G.M.T. at time and place.

To find the Longitude:—

Under the G.M.T., found as above, place the time by watch (corrected for its error on mean time *at Place*), their difference will be the Longitude in time, East, if the time at Place be the greater, West, if the time be the lesser; and the Longitude thus found is absolute (i.e.) independent of any time-keeper, or derived directly from an observation.

Should it be found that the assumed Longitude has been so much in error as to cause a large error in the approximate G.M.T., the whole should be computed again with the G.M.T. found as the Greenwich date for correcting the elements taken from the 'Nautical Almanac.' But this is seldom likely to be the case, as the error of the approximate G.D. would have to be very large to have much effect on the corrections applied to the elements taken from the 'Nautical Almanac.'—*See also*

Raper (Art. 615, page 203, 12th edition), on the errors of the Hour Angle, which is a very simple method of finding the error caused by error either in Alt., Lat. or Polar Dist., and therefore for any small number of minutes or seconds in a like proportion.

Example.

At Mitcham, Oct. 23rd, 1880.—The following is the mean of a set of Altitudes of the \sphericalangle taken in an artificial horizon, and the corresponding times, to determine the Long. by computing the \sphericalangle 's R.A. at time and place of observation. The moon was East of the Meridian. The error of the watch on mean time at place had been previously determined, and the index error of the sextant was $-1' 10''$. Latitude, $51^{\circ} 24' 12''$ N. Estimated Longitude, $10^{\circ} 00''$ W.

Mean of the times	H. M. S.	Sidereal time at M. Noon 23rd	H. M. S.
Watch fast on M. T. at place	9 53 30	Acceleration for W. Long.	14 9 6.90
	— 18		+ .11
Mean time at place =	9 53 12	Red. S. T. at M. Noon	14 9 7.01
W. Longitude in time.. ..	+ 40	Mean time at Place	+ 9 53 12
Approximate G. T. M. .. =	9 53 52	Acceleration for M. T. at Place	+ 1 37.45
		Sidereal time at Place	3 56.46
	Obs. Alt. \sphericalangle in Art. Horizon.		
	0' " "	\sphericalangle 's Hor. Par. Oct. 23 Noon ..	54 11.7
Index error	\sphericalangle 27 43 42	" " Mid. ..	54 10.3
	— 1 10	12 hours' variation =	1.4
	2) 27 42 32		Corr. for Lat. ..
Aug. Semid.	13 51 16		54 10.6
	+ 14 50.8		— 6.6
	14 6 6.8		\sphericalangle 's Corr. } 54 4.0
Bar. 29.5 Corr. in } Ther. 40° Alt. }	+ 48 38.6	\sphericalangle 's Declination at 10 hours ..	22 48 2.6 N.
\sphericalangle 's True Alt.	14 54 45.4	Correction by the diff. for 10m. } (N. A.) }	+ 22.5
			22 48 25.1
		\sphericalangle 's North Polar distance	67 11 34.9
		\sphericalangle 's Semidiameter	14 47.3
		Augmentation	+ 3.5
		Augmented Semid.	14 50.8

	°	"		
Altitude	14	54	45	
Latitude	51	24	12	S-cant. 0° 20' 49.31
Polar Dist.	67	11	35	Co-secant 0° 03' 55.56
	2) 133 30 32			
‡ Sum	66	45	16	Cosine 9° 59' 52.36
‡ Sum—Alt.	51	50	31	Sine 9° 89' 55.94
	Log sin sq. =			} 9° 73' 21.17
	H. M. S.			
	6 18 11			

		H. M. S.	
East Hour /		6 18 11	
Sidereal Time at Place	+	3 56.46	
D's Computed R. A.	=	6 22 7.46	Constant. 4771
D's R. A. at 9 hours (N. A.) ..	=	6 20 12.75	Pro. Log. 1m. 54° 7' 18. 1° 9' 739
Diff.		1 54.71	2° 45' 10
			Pro. Log. 2m. 7° 348. 1° 9' 285
		H. M. S.	
D's R. A. at 9 hours (N. A.) ..	=	6 20 12.75	54m. 38. = Pro. Log. 0° 52' 25
" 10 hours (N. A.) ..	=	6 22 20.09	
Diff.		2 7.34	

		H. M. S.	
Nautical Almanac Hour of Next Less R. A.		9 00 00	
Correction		+ 54 3	
G. M. T. Corresponding to Computed Right Ascension		9 54 3	
Mean Time at Place.		9 53 12	
Longitude in Time		00 00 51 = 00 12 45 W.	

To find the Longitude by the Occultation of a fixed Star.

The moon in its monthly revolutions round the earth frequently passes between the earth and a fixed star so as to intercept a spectator's view of the latter; the disappearance of a star from this cause is called an *immersion*, and its re-appearance from behind the moon is called an *emersion*. A list of these phenomena is given in the 'Nautical Almanac,' with the limits in Latitude beyond which a star cannot be occulted by the moon; as the elements refer to the moon and star, as they would be seen from the earth's centre, they serve equally for all places on the earth's surface. This observation is much easier and more certain in its results than the lunar observation; as the instrument (the telescope) is one that every person can use, and is not liable to any error, all that is required is, that the observer shall be certain that one instant he does see the star and that the next instant he does not (with an emersion the exact contrary is the case). Neither is there much difficulty in recognising the star, its position with reference to the moon being clearly pointed out in the 'Nautical Almanac,' and as the moon only moves its own diameter, among the stars in an hour, there is ample time after the star and moon are in, apparent, close proximity, to make sure of the star. Before, or immediately after this observation, a set of sights should be taken to find the error of the watch on apparent or mean time at place. When a traveller has decided to observe an occultation, he should, during the day, find the local time of that phenomenon, by applying the assumed longitude in time to the G.M.T. of conjunction in R.A. of the moon and star, which he will find among the elements of occultations in the 'Nautical Almanac,' adding the longitude in time if it be *East*, and *subtracting* if it be *West*. An hour before the time so found, he should point his telescope to that limb of the moon by which the star will be occulted; it is necessary to take this precaution as his assumed longitude, and therefore his time, may be considerably in error. The moon will be seen to approach the star from West to East until its eastern limb will reach the star and occult it; note the instant when this takes place. After a certain interval the star will re-appear on the other side of the moon; note this time also. Either of these observations are sufficient to determine the G.M.T., and thence

the Longitude in the manner shown in the example. When the star is occulted by the moon's dark limb, the observation will afford most decisive results. At or near full moon a star occulted by the bright limb is not so easy an observation. A three-draw telescope, with a *good* object-glass of two inches clear aperture, fitted with an astronomical eye-piece having a magnifying power of 40, and a clip with an universal joint, which can be screwed into a tree, or preferably, into some other fixed support, is well adapted for taking this observation. The example given is computed by Raper's rule and tables. It will be observed that several of the logs can be taken at one opening of the book, and as only four places of decimals are used, the Log sines, cosines, &c., can be taken at sight to the nearest 30"; this is not, however, the case with the proportional logs; where they occur the strictest accuracy must be observed, and the decimals of seconds must not be neglected. This remark also applies to the Moon's Declination, Right Ascension, Horizontal Parallax, and Semidiameter.

December 10th, 1881.—At Mitcham, Lat. $51^{\circ} 24' 12''$ N., assumed Longitude $9^{\circ} 30''$ W., observed the immersion of ω Leonis East of the meridian; the time was taken by a watch which had been found by previous observation to be 2 m. 7 secs. slow on mean time at place; the moon east of the meridian.

Longitude by the Occultation of a Star.

H. M. S.	'	"	'	"
Time by Watch of Immersion } 13 52 40				
or emersion				
Error of Watch... .. .	+	2	7	
Mean Time at Place	13	54	47	
Assumed Long. in Time	+	38		
Corresponding G. D.	13	55	25	

Δ 's Semid. (p. iii. N. A.) ; "	14	46	8
Δ 's Hor. Par. Midd.
Δ 's Hor. Par. Noon
12 Hourly Diff.
Latitude	51	24	12
Reduction (LII.)
Geocentric Lat.	51	13	1

Corr. for 12 Hourly Dmfr. (XXI.) = 00 00.1
 Δ 's Hor. Par. Midd. = 54 9.1
 Δ 's Hor. Par. corr. for G. D. .. = 54 9
 Correction for Lat. (XLI.) = 6.7
 Δ 's Reduced Hor. Par. = 54 2.3

Month. Day.	H.	M.	S.
Sidereal Time Dec. 10 (p. ii. N. A.)	17	17	24.23
13 H.
55 M.
25 S.
Reduced Sidl. Time	17	19	41.47
Mean Time at Place	13	54	47
R. A. of Meridian - 24 H.
*'s Right Ascension	9	14	28.47
*'s Hour Angle	2	7	41.23
*'s Declination	0	'	"
*'s Reduced Hor. Par. pro Log	9	34	3.3 N.

Δ 's Declination Dec. 10th at 13 = 0 30 6.1 N.
 * Variation of Decl. in 1' $9^{\circ} 888 \times 55'$ of } = - 9 3.8
 G. D.

Reduced Declination = 10 21 2.3
 * The variation in 1 m. is found by removing the decimal point, in the difference of Declination in 10 minutes (given in the 'Nautical Almanac') one figure to the left hand.

*'s Declination	0	'	"
Δ 's Reduced Hor. Par. pro Log	0	'	5226
Geocentric Latitude, Cossec.
*'s Declination, Secant.
*'s Hour \angle Sec.
Arc A = 41 32 = Pro Log = 0.6369
Arc C = 00 00
(A-C) = 41 32

*'s Hour \angle Sec.	0	'	0712
* Sum of 3 Logs.
Arc B = 4 46.4 = Pro Log. = 1.5764
Constant
*'s Declination Cotan
Arc C = 00 00 = Pro Log = 4.3603

*To find the Longitude by Eclipses of Jupiter's Satellites.**

In the 'Nautical Almanac' will be found the configuration of Jupiter's Satellites for every day in the year, except when Jupiter is so close to the sun that his satellites are invisible; these diagrams are given for North Latitude, and must be reversed for South Latitude. When Jupiter comes to the meridian before midnight, the whole eclipse (both immersion and emersion) takes place on the *East* side of the Planet; when after midnight, on the *West* side. As an inverting telescope must be used, this will appear to be reversed. The error of the watch on mean time at place should be found from observations of the Sun's, or a fixed star's altitude in the manner already described; but if Jupiter is more than 3 hours from the meridian at the time of the immersion or emersion of one of his satellites, and if Jupiter's altitude be taken at the instant of observing the immersion or emersion, the use of a watch will be unnecessary; as the 'Nautical Almanac' will furnish the Greenwich date required; this, of course, can only be done when there are two observers. As a rule, the *first* satellite is to be preferred, as its motion is more rapid than that of the other three. The explanations given in the 'Nautical Almanac' are so clear that they leave nothing to be added.

The observation.—Having estimated the local time of the phenomenon with the assumed Longitude, and the time given in the 'Nautical Almanac,' be ready some time before the eclipse will take place with a telescope, having a magnifying power of not less than 30, and note the instant of the disappearance or re-appearance of the satellite. It must be remembered that either of these events (being caused by the shadow of the Planet) may take place when the satellite is at a considerable distance from Jupiter. The difference between mean time at place when the observation was taken and the mean time at Greenwich, given in the 'Nautical Almanac,' is the Longitude, as shown in the following example:—

At Mitcham, Nov. 30th, 1881, observed the emersion of the 1st satellite

* "This method, though easy and convenient, is not very accurate; the eclipse is not instantaneous, and the clearness of the air, and the power employed, affect considerably the time of the phenomenon. Observers have been found to differ 40 sec. or 50 sec. in the same eclipse."—*Raper*.

of Jupiter, at 10 h. 25 m. 4 sec, the error of the watch on *local* mean time being 33 secs. slow.

	H.	M.	S.	
Time by Watch	10	25	4	
Error of Watch		+	33	
	10	25	37	
M. T. at Greenwich 'Nautical Almanac'	10	26	16	, "
Longitude in Time	39			= 9 45 W.

13. TO FIND THE LATITUDE BY OBSERVING THE TIMES WHEN TWO DIFFERENT PAIRS OF STARS ARE VERTICAL ONE ABOVE THE OTHER (*i.e.* IN THE SAME AZIMUTH CIRCLE).

It sometimes happens that a traveller may be so unfortunate as to lose or injure his Sextant, in which case he may, with a plumb-line, a pair of compasses, and the scale of chords and semi-tangents, obtain approximately his Latitude. The declinations and right ascensions of the stars, with their annual variations, are given on page 152; a watch is also required to take the intervals.

NOTE.—All stars which rise in this position Δ^1 * B^1 , set in this position * B^2 * A^2 ; therefore there must be a time when the star Δ^1 will be directly over star B^1 , or it could never reach the position Δ^2 . A series of observations taken by the following rule will give a very good approximate Latitude:—

The observation.—With a plumb-line, observe when two stars appear to be in a vertical position, and note the time. Then watch until another pair of stars appear (in the same way) vertical to one another, and note this time; take the difference between these two times, and call it *Interval*.

To project the problem Stereographically on the plane of the Equinoctial:— With the chord of 60° describe a circle to represent the Celestial Equator; and taking any point of this to represent the first point of *Aries*, set off on it (by the scale of chords) the Right Ascensions of the four stars, decreased for the two of the last pair (but for these two only) by the Interval already noted. The radii of the primitive drawn to the four points thus set off represent circles of declination; on which set off, from the centre, the respective polar distances of the stars, taken on the compasses from the scale of semi-tangents. If the scale of tangents is used, then, *half* the polar distances are to be taken.

Next describe an oblique circle through each of these pairs of stars;

and the point where these two circles intersect one another will be the Zenith. The distance between this point and the centre of the circle, which represents the Pole, will be the complement of the Latitude, called co-Latitude, which is to be measured from the scale of semi-tangents; or if taken from the scale of tangents, the angle indicated on the scale must be doubled. This measure subtracted from 90° is the Latitude.

To measure an arc of more than 90° by the scale of chords:—

Set off, first an arc of 90° ; and from the farther end of that arc, set off the excess. For instance, to set off an angle of 130° , set off first 90° , and beyond it 40° .

Preparatory problem: To describe an oblique circle which shall pass through two given points, as A, B:—

From the centre P describe the circle D H G E, as the primitive. From the point A, through the centre P draw the line A P G, and draw the line H P E perpendicular to A P G. A ruler laid on E and A will intersect the primitive at D; and a ruler from D through P will give F: then a line drawn through F from E will intersect A P G (produced) at G'. Draw A B and B G'; and from the centre of these lines, erect perpendiculars; C, the point of intersection, will be the centre of an oblique circle which shall pass through the points A B G'.

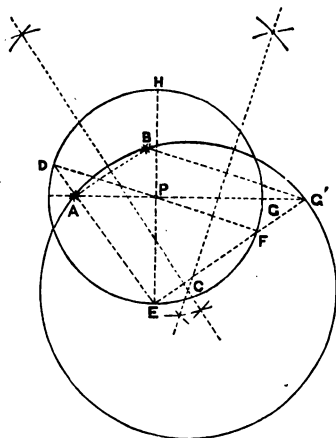

Example.

At Mitcham, Surrey, Feb. 4th., 1881, the following observation was taken with a plumb-line:—

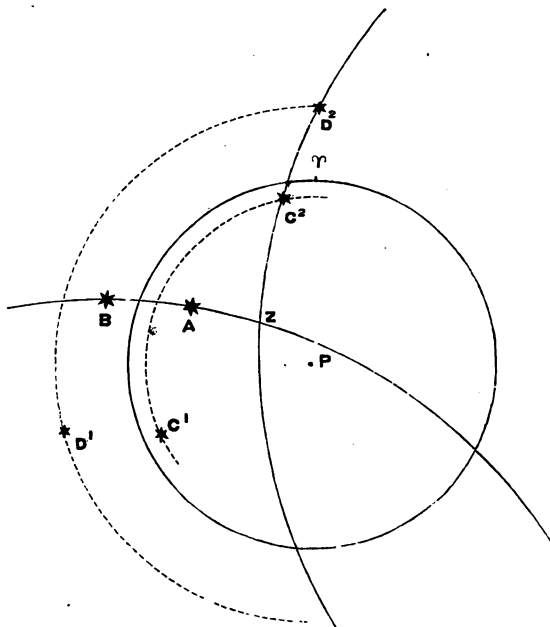

			H.	M.
Aldebaran and Rigel, vertical	6	38
Sirius and Procyon, vertical	13	22
Interval	6	44
Z. P. Co-Lat.	38	36
			90	00
Latitude	51	24
				00 N.

Note.—In North Latitude, when the declination is South, add declination to 90° , take half of this sum in the compasses measured from scale of tangents (= semi-tangents), lay this off from the centre of the primitive.

The same rule applies in South Latitude when the declination is North.

14. TO FIND THE TRUE MERIDIAN.

With the Transit Theodolite.

Find the time of the meridian passage of the Pole Star by Table V. or the 'Nautical Almanac.' Level the instrument, and if this be carefully done, the line of collimation will move in a plane perpendicular to the horizon, and will pass through the Zenith; then by making it also pass through the celestial pole, and clamping the horizontal plates when it is in that position, the movements of the telescope will be restricted to the plane of the meridian. This is done by turning the telescope on to the Pole Star, and covering it with the point of intersection of the telescope wires at the time (previously ascertained) of its upper or lower culmination, and then firmly clamping the Horizontal plates. The meridian line should now be laid out to the North and South of the observer, by sending a man with a lantern and a staff in both directions, and making him drive the staff into the ground at the spot where the observer sees the lantern in a central position on the cross wires of the telescope.

In South Latitude any star may be used if the local time is accurately known, and the time of the star's meridian passage carefully computed. The observation is precisely the same as for the pole star, but it would be well to take more than one star in order to correct any errors that may have been made in observation or computation. Though the results of such observations as these are susceptible of a great degree of precision, yet absolute accuracy must not be expected; they will, however, be quite close enough for any purpose that an ordinary traveller is likely to require.

If local time is not accurately known, the true meridian may be found in the following manner:—Carefully level the transit theodolite, and set the 360° division as nearly *true* north as you can get it by the attached magnetic needle, then clamp the lower plate, and unclamp the vernier plate, select any star at some considerable distance east of the meridian,

and cover it with the intersection of the threads in the diaphragm, *clamp the vertical circle*, and take the reading on the horizontal plate; then, after the necessary interval, watch the star until it is again covered with the intersection of the threads in the diaphragm west of the meridian take the reading, and then the theodolite will point just as far west of the meridian as it originally did to the east, and a point midway between these two horizontal readings will be in the true meridian. Care must be taken to keep the vertical circle and the lower plate clamped during the interval between these two observations. Having thus found the true meridian it can be marked as previously directed.

(See also *True bearing*, p. 66).

By the Sun, without instruments.

Having levelled a piece of ground of sufficient size, plant a rod in a truly perpendicular position, testing it with a plumb-line, and at

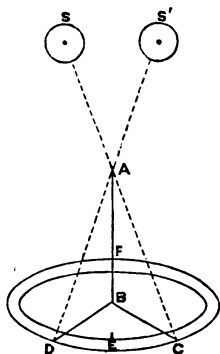

an hour or two before noon (say 10.30) mark accurately the extremity, C, of the shadow, BC, thrown by the rod when the sun is in the position S; then from the base, B, of the rod as a centre, with the radius BC, the length of the shadow, describe the circle, DCF, upon the ground. As the sun's altitude increases, the shadow of the rod will fall

within the circumference of the circle, and will gradually grow shorter until noon; after which, as the sun's altitude decreases, the shadow of the rod will grow longer until, at last, when the sun has attained the position S', it will reach the circumference of the circle at the point D. Divide the arc, C D, into two equal parts, and from E, a point equidistant from C and D, draw a line through the centre, B, and that line will coincide, approximately, with the true meridian.

15. METHOD OF MAKING ROUTE SURVEYS THROUGH JUNGLE OR FOREST OR ON A STEEP HILL-SIDE. By Lieut.-Col. R. G. WOODTHORPE, R.E.

In speaking of this method of surveying, Col. Woodthorpe says:—“I first adopted it in 1871-72, during the preliminary reconnaissances in the Garo Hills Expedition, when the nature of the country passed through, prevented any stepping off the path, and the hostility of the Garos prevented any lagging behind. The method was as follows:—Just before starting on the day's march, I compared the direction of my shadow with each of a round of bearings taken with a prismatic compass; and on starting, I took the general direction of the road with the compass, and rays to any known points. During the march also, any great changes in the direction of the road were taken with the compass, but all minor changes of direction I obtained by watching my own shadow when the sun was behind me, and the shadow of a man in front when the sun was before me; and whenever a halt was made I checked the bearings of my shadow anew to find the variation due to the sun's motion during the day.

A little practice soon renders one very independent of the compass for short distances, and I could generally guess a bearing to within 2° or 3° of the truth. This error in short distances, when the route is not plotted to any large scale, is of no importance. To find the distance, I noted the time taken in traversing each by a watch reading seconds, occasionally pacing 100 yards to find the rate of going, all halts or checks, of course, being noted also.

By this method, frequent stoppages of the whole line in a narrow path, from which it was impossible to step aside to take compass readings, were avoided. The compass is often affected by the proximity of arms

and accoutrements, and this difficulty is also overcome. The changes in the direction of a path through jungle, or on a hill-side, where there is no made road, are very frequent; and observations of shadows enable one to determine, without observing the compass, whether the direction of the path really changes, or only alters for a few yards, resuming the old course again. Accurate measurements by pacing are only obtainable by keeping up a continuous steady walk, which it is impossible to do with the frequent checks or spasmodic accelerations of pace on a line of march; but I found by repeated trials that the rate of a column does not vary nearly so greatly as the pace of any one individual; in it considerable practice is necessary to acquire accuracy in steep ground, but in tolerably easy country I found I could easily obtain it. Fortunately for this method, all countries are not so sunless as England, on one occasion I made a route survey in this way for about forty miles of hill and dale, with only one check ray to a known point; and when it was transferred to an accurate survey which was afterwards made of the country traversed by it, its last station was found to be hardly out at all in Latitude and not half a mile in Longitude. In the cold weather of 1876-77 I had to survey some rapid shallow streams running through dense jungle, and whenever we were going into the stream in our dugouts (i.e. native boats, each hollowed out of a single tree) I found the best plan of surveying was with a prismatic compass suspended in gimbals mounted on a small tripod stand set up in front of my seat in the boat. I measured certain distances along the bank, and carefully noted the time one boat took to pass them, carried down by the current only. The compass gave the bearing throughout the length of the reach, and the watch gave the distance, and I found quite sufficiently accurate results were obtained. In actual measurements of shallow streams, when a subtense instrument is not available, I found canes to be invaluable. They grow everywhere in the forests in Assam, and lengths of 100 feet each were easily procurable. Their lightness caused them to float on the surface of the water, they were constant as to their length, and gave no trouble to the chainmen in pulling them taut in the water. They were very useful in measuring through the jungle and forest undergrowth, through which they could be drawn without being caught by thorns in the bushes, advantages not possessed by chains or ropes."

16. SURVEYS WITH SEXTANT AND PRISMATIC COMPASS.*

By Col. Sir C. W. WILSON, K.C.M.G., R.E.

A traveller who intends to devote a portion of his time to the survey of the country he is about to visit, should consider before leaving home what he is going to do, and how he will do it. The character of the proposed survey, the projection to which it is to be referred, the scale or scales to be adopted, the instruments to be used, should be carefully thought over before commencing work, and there should be no hesitation when once upon the ground. A decision on these points depends on various considerations—such as the time and means at the disposal of the traveller, the object in view, the nature and geographical position of the country, &c.; and the following notes are confined to a few hints which may be useful in the field.

Projection.—When the extent of country to be laid down is small, it may be treated as a plane-surface, but when it is considerable, allowance must be made for curvature, and some projection of the sphere, or a portion of the sphere, adopted. The projection should be selected with reference to the latitude and local peculiarities of the country to be surveyed; the sheets should be prepared before leaving home by a competent draughtsman, and two or more copies of each taken, packed in a round tin plan-case. It may happen, however, that a projection has to be made in the field, and a few notes are given on the construction of Mercator's, the Conical, and the Rectangular Tangential Projections. In *Mercator's Projection* the true proportions are preserved between the meridians and the parallels, and the figures of the objects delineated are in every part correct; but the exaggeration at a distance from the Equator is so great that, beyond 50° or 60° a circular or polar projection is preferable. The advantage of Mercator's projection is, that the bearing and distance of one place from another, as measured on the map, is the same as on the globe itself; the traveller can thus lay down his route upon it with great readiness. The *Conical Projection* is well adapted for the representation of small portions of the sphere: but if the map is extended much above or below the middle latitude, the distant parts will be

* It will be understood, that if a small theodolite can be carried, the work of surveying will be greatly facilitated.

greatly distorted. The *Rectangular Tangential Projection* is well suited for maps on a scale of 10 miles to an inch; and the tables published by the late Sir Henry James provide the means of readily constructing the sheets required.

Scale.—For the fair plan, a scale of 10 miles to an inch is recommended, for the field-sketch or outdoor-work, a scale of 2 miles to the inch; or, if much detail is required, of one mile to the inch. The scale of 2 miles to the inch has this advantage—that the ordinary sketching-card 12" × 15" will contain sufficient ground—24 miles × 30 miles—for the day's work, and most of the points to which bearings are taken.

The classes of *Survey* to which attention may be directed are—1. A simple route-survey; 2. A district-survey; 3. A special survey of a small tract of country; and 4. A survey of a plot of ground containing ruins, &c. The only instruments supposed to be available are—sextant, watch or chronometer, prismatic compass, measuring tape, aneroid, &c.

1. *Route Survey.*—Arrived on the ground, the traveller must first fix, with as much accuracy as possible, the position of some point on the earth's surface to which his work may be referred. If he starts from the coast-line, the position of some well-defined point can generally be obtained from the Admiralty Charts, but if no such resource is available, the position of his initial point must be determined by astronomical observations. The latitude can be obtained by a good observer with a 6" sextant to about 100 yards on the earth's surface; but the longitude cannot be found by lunar distances to within ten minutes (10 miles on the Equator). The position of the initial point, A, having been determined, work commences. The true bearing of some well-defined distant peak, or other landmark, is obtained, and this having been made "zero," a round of angles is taken with the sextant to conspicuous objects, some of which should be in the direction of the proposed line of march, and, if possible, near the first halting-place. Several observations of the zero-point are made with the compass, the needle being deflected each time, to obtain the variation, and the aneroid read for altitude. All angles should be booked at once in ink, and the names of the observed objects carefully noted; a rough outline-sketch of the peaks or other landmarks will be found useful in identifying points as the work proceeds. The initial point, A, is pricked off on the sketching-card in a suitable position for laying down the day's march, and surrounded by a circle \odot ; the observed

angles are plotted; and a magnetic meridian is drawn; all is then ready for plotting the route. The compass is set up at *A*, and the sights of the instrument are directed on some object, *b'*, in the direction of the line of march; the bearing of *b'* is read off and plotted from *A* on the field-sheet by means of the protractor; bearings are then taken to conspicuous objects such as *X*, which appear to lie near the line of march, and these are

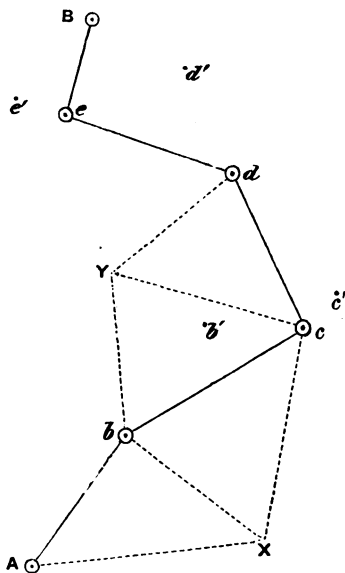

likewise plotted. The march now commences in the direction of *Ab'*, and is continued to the point *b* where the route is found to turn to the right; the distance *Ab*, measured during the march, is laid down upon the field-sheet, and the point *b*, surrounded by a circle \odot ; the compass is then set up at *b*, and the bearing of an object, *c'*, in the direction of the new line of march, read off and plotted from *b* on the field-sheet; bearings are also taken to objects, such as *X*, *Y*, on either side of the route, and plotted;

the point X having also been observed from A, is now fixed. The march is again taken up in the direction $b c'$ until a point c is reached, at which the road bends to the left, the distance $b c$ laid down, and so on until camp B is reached. At B, observations should be made in the evening for time and latitude; and in the morning, observations similar to those which have been made at A. Should the camp be near one of the points observed to from A, the distance and true bearing of such point from B should be determined, with a view of fixing its position. At certain camps the longitude should be found by lunar distances, to serve as a check on the traverse-survey. Distances on the line of march may be measured by counting or timing the paces of a man, or by counting or timing the paces of a horse, mule, camel, &c., whose length of step is known. Time-measurement will be found most convenient, and, with care, will give very good results. Compass-bearings need only be taken at every second station on the line of march. Objects on either hand should, where possible, be fixed by three bearings. It is not desirable to take compass-bearings to points more than 6 or 7 miles distant, as the prismatic compass can seldom be depended upon to within one degree, and an error of this amount in 6 or 7 miles would give an error of $\cdot 05$ inch on a scale of 2 miles to the inch. If the route runs near a peak, of which the true bearing has been determined from A, it should be ascended, and a round of angles taken with the sextant, making A the zero-point. When there is a mid-day halt, the meridian altitude of the sun should be observed. If a field-sketch cannot be kept up, the route should be entered in a field-book, and afterwards plotted, before details are forgotten. A book—with every alternate page ruled into squares by strong lines, and subdivided by finer lines, the smaller squares representing five minute intervals of time, the larger ones one hour—will be found of great use in making a rough sketch of the route, or a modification of the form used in booking a traverse-survey may be adopted; in all cases the bearings, distances, &c., should be clearly written in the book.

In this field-sketch the ground has been treated as a plane surface, and as soon as convenient the work should be transferred to the projection on the fair plan. In doing this it becomes necessary to calculate the latitudes and longitudes of the camps, and other points, from the material provided by the survey; when this has been done, the fixed points are laid down

in their true position on the map, and the detail reduced to the proper scale.

2. *District Survey*.—The basis of any survey of an extensive district should be a system of triangulation, and the first step is the measurement of a base line. With no instruments except a sextant, tape, and prismatic compass, the best plan is to measure an astronomical base, and thence extend the triangulation as far as may be necessary. Two suitable points, A and B, lying nearly north and south of each other, are selected as the ends of the proposed base; the position of A on the earth's surface is determined at the point itself, the true bearing of B from A is obtained, and B having been made zero, a round of angles is taken with the sextant

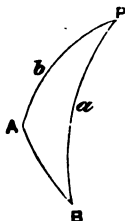

to conspicuous points; camp is then moved to the vicinity of B, and observations for latitude made at that point; the true bearing of A from B is then obtained, and a round of angles taken to the points previously observed to from A. The length of the base AB can then be computed, and the position of several of the points observed to from A and B determined. The fixed points are next laid down on the field-sheet, and the detail filled in with the prismatic compass. In this way the triangulation may be extended over the district to be surveyed, care being taken to check the work occasionally by observations for latitude at selected points.

The following notes and problems* will be found useful in constructing the map:—

Problem I.—Let A and B be two stations visible from one another, $AP = b$, $BP = a$, their observed co-latitudes, the angles A and B their

* Problems II.-V. are taken from Frome's 'Outline of a Trigonometrical Survey,' revised by F. Capt. Warren, R.E.

reciprocal true azimuths, and APB, or P, the required angular difference of longitude. Then by spherical trigonometry—

$$\text{Cot. } \frac{1}{2} P = \frac{\cos. \frac{1}{2} (a + b)}{\cos. \frac{1}{2} (a - b)} \tan. \frac{1}{2} (A + B)$$

which determines P.

Problem II.—The latitude and longitude of any point being known, that of any other point within a short distance can be determined by plane trigonometry. Suppose the latitude and longitude of the camp at A to be

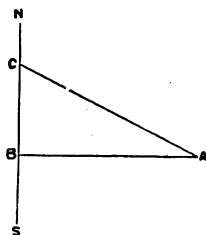

known, whence that of a neighbouring peak or land-mark, C, is to be determined; the distance AC must be measured, and the azimuth NCA observed, then the difference of longitude AB is the sine of ACB to radius AC, and the difference of latitude BC is the co-sine to the same angle and radius.

Problem III.—The distance between two places is generally resolved

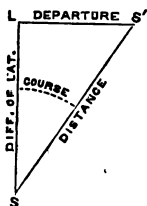

by plane trigonometry, the difference of latitude SL, and the azimuth S'SL, called the *course*, forming a right-angled triangle, in which SS', the

distance, is determined; the other side LS' , termed *departure*, being the sum of all the meridional distances passed over.

Problem IV.—Given the distance travelled on a given parallel of latitude to find the difference of longitude.

Again, in the triangle ABC , let AB represent the distance or departure,

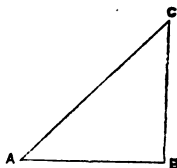

and the angle BAC be equal to the latitude, then AC , the hypotenuse, will be equal to the difference in the longitude.

Problem V.—Given the departure to find the difference of longitude.

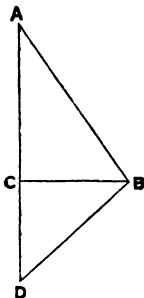

Also, if DB represent the distance, and CD the difference of latitude, then BCD will be a right angle, and BC the departure, nearly equal to the meridian distance in the middle latitude. If, then, in the triangle ABC the angle ABC be measured by that middle latitude, AB , the hypotenuse will be nearly equal to the difference of longitude between D and B .

For the variation of the compass, it is convenient to take a bearing of the sun at sunset or sunrise; or, if this cannot be done, an azimuth of

the sun at any time three hours before or after noon will answer equally well. The angular distance between the sun, when its own diameter is above the horizon, and any well-defined peak, measured with the sextant, gives the true bearing.

To find the sun's true amplitude for any day:—to the log-secant of the

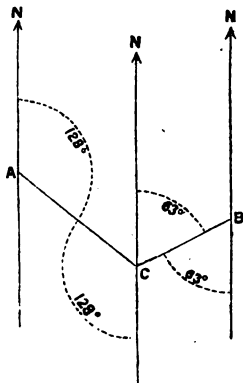

latitude, rejecting the index, add the log-sine of the sun's declination corrected for the time and place of observation. Their sum will be the log-sine of the true amplitude. If the true and magnetic amplitudes be both north or both south, their difference is the variation; but if one be north and the other south, their sum is the variation; and to know whether it be easterly or westerly, suppose the observer looking towards that point of the compass representing the magnetic amplitude; then, if the true amplitude be to the right hand of the magnetic, the variation is east, but if to the left hand, it is west.

In filling in a survey, the observer can fix his position, C, by observing two fixed points, A and B, and plotting from those points the opposite bearings to those observed, their intersection fixes the point required. The nearer the two bearings meet at a right angle the more correct will the point be determined, and, if a third fixed point is visible, a bearing to it will act as a check on the other.

A third and accurate method of fixing the position is by the angles

subtended between three known objects. The instrument called the station-pointer is generally used for this purpose; but the position may also be found with a pair of compasses and a protractor, or, more simply, as follows, by means of a protractor and a sheet of tracing paper. Draw a line through the centre of the paper; place the protractor on it near to the bottom of the sheet; lay off the right-hand angle to the right, and the left-hand angle to the left of the centre line; rule pencil-lines, radiating from the point over which the centre of the protractor has been placed, to the points that has been laid off; then place the paper on the plan or map, and move it about until the three lines coincide with the objects taken; prick through the points that lay beneath the centre of the protractor, and the observer's position is transferred to the plan. When possible, the centre object should be the nearest.

Any object whose true bearing is east or west must be in the same latitude as the place of the observer.

Any object whose true bearing is north or south must be in the same longitude as the observer.

3. *Special survey of a small tract of country, with compass and tape only.*—First walk over the ground and examine it, with a view to the selection of prominent points for stations, and of a level space for the measurement of a base. Having fixed upon a base, AB, set the compass up at A and take a round of bearings to B and other selected stations, C, D, E, &c.; then mark A on the field-sheet, in such a position as will enable the whole sketch to go on the sheet, and protract the several bearings from it. Mark A on the ground with a pile of stones or staff, measure the base A B with the tape or by pacing, lay the distance down on the field-sheet to the adopted scale, set the compass up at B and take a round of bearings to A, C, D, E, &c. These bearings are now plotted and their intersections with the bearings from A fix C, D, E, &c.; in this manner a rough triangulation is established and a number of points fixed, by the aid of which the detail can be filled in.

The paper, or field-sheet, for sketching with a prismatic compass should have parallel lines at unequal distances ruled upon it, to be considered as east and west lines.

4. *Survey of a plot of ground containing ruins, &c.*—In making a survey with a tape alone we are confined to the simplest geometrical figure—the triangle, as it is the only one of which the form cannot be altered, if the

sides remain constant. In carrying out such a survey, divide the surface into a series of imaginary triangles as large as the nature of the ground will admit of, and attend to the following rules:—

1. Do not be in a hurry to commence work, but walk over the ground and make a rough eye-sketch of it on paper.
2. Select two points, as far apart as possible, visible from each other

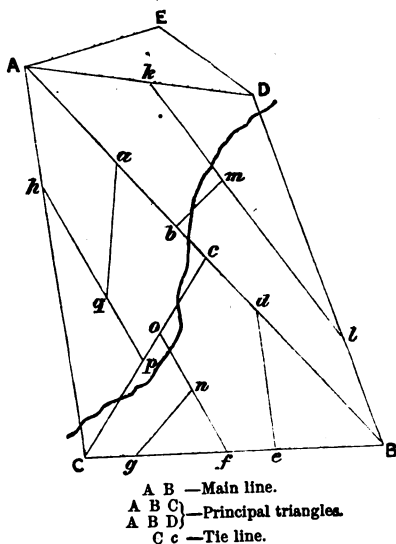

and commanding a good view; let the points be near the boundaries of the ground, and so situated that the line joining them forms a sort of diagonal; this becomes the *main* line.

3. Select a point on each side of the main line, near the boundary of the work, to which lines can be measured from each end of it, thus giving two large triangles; then measure a check, or *tie* line, from one of the vertices to a point at or near the middle of the opposite side.

4. On the sides of these triangles erect smaller ones to embrace all the ground to be surveyed.

5. Measure lines from any station laid down, or from any part of a line

connecting two of them in directions most convenient for obtaining the detail, taking offsets to such objects as present themselves.

The interiors of large buildings should be measured in a somewhat similar way by dividing them into imaginary triangles and measuring tie lines.

The great principle in all surveys is to work from a whole to the parts, errors are thus sub-divided and time and labour economised.

The following symbols are recommended for adoption:—

\angle 's	signifies	angles.
\triangle	a station in the	triangulation.
\ominus	„	fixed by latitude.
\odot	„	„ longitude.
\oplus	„	„ lat. and long.
\odot	„	„ true bearing.
R. t.	„	„ right tangent.
L. t.	„	„ left „

MAP PROJECTIONS.

Mercator's Projection.

On a sheet of cartridge paper, 13 inches by 20, it is proposed to construct a map on Mercator's projection, on a scale of 10 miles to an inch, equatorial—*i.e.* 6 inches to the degree of longitude.

$$\text{Limits of the Map } \left\{ \begin{array}{l} \text{Lat. } 31^{\circ} \text{ to } 33^{\circ} \text{ N.} \\ \text{Long. } 34^{\circ} \text{ to } 36^{\circ} \text{ E.} \end{array} \right.$$

Draw a base line, find its centre, and erect a perpendicular to the top of the paper; the extremes of longitude 34° and 36° added together and divided by 2, give 35° the central meridian, and which is represented by the perpendicular; on each side of it lay off 6 inches, and erect perpendiculars for the meridians 34 and 36; divide the base line into 10-mile divisions, and the part from $35^{\circ} 50'$ to $36^{\circ} 00'$ into miles for the latitude scale.

From Table A, take the following quantities:—

Lat. 31° to 32°	$= 1^{\circ} 10'4$	= the distance between parallels 31° and 32°
„ 32° to 33°	$= 1^{\circ} 11'1$	„ „ „ 32° „ 33°
	<hr/>	
	$2^{\circ} 21'5$	„ „ „ 31° „ 33°

(A.)—TABLE TO CONSTRUCT MAPS ON MEBATOR'S PROJECTIONS.

	0	1	2	3	4	5	6	7	8	9
0	0 1	0 1	0 1	0 1	0 1	0 1	0 1	0 1	0 1	0 1
10	1 00.9	1 01	1 01.2	1 01.5	1 00.7	1 00.2	1 00.3	1 00.4	1 00.5	1 00.6
20	1 03.6	1 04.1	1 04.5	1 04.9	1 05.5	1 05.9	1 06.5	1 07	1 07.7	1 08.2
30	1 09	1 09.6	1 10.4	1 11.1	1 12	1 12.8	1 13.7	1 14.6	1 15.7	1 16
40	1 17.6	1 18	1 20.1	1 21.4	1 22.7	1 24.2	1 25.6	1 27.1	1 28.8	1 30.6
50	1 32.4	1 34.3	1 36.4	1 38.6	1 40.8	1 43.4	1 45.9	1 49	1 51.4	1 54.8
60	1 58.3	2 01.8	2 05.8	2 09.9	2 14.5	2 19.14	2 24.7	2 30.5	2 36.8	2 43.8
70	2 51.3	2 59.8	3 09.1	3 19.6	3 31.3	3 44.6	3 59.8	4 17.1	4 37.4	5 01.1
80	5 29.5	6 03	6 46.4	7 40.3	8 51.1	10 27.7	12 47.9	16 29.6	23 4.3	39 42.2

USE OF THE TABLE.

Find in the Table the required parallel: the tens at the side, and the units at the top. At their intersection will be found, in degrees and minutes, the distance of the required parallel from the next less degree; to be measured from the scale of longitude on the map in progress.

Given the parallel of 30°—required that of 31°.

30 at the side, and 1 at the top, intersects at 1° 09' 6", the required distance of the two parallels.

Given the parallel of 31°—required that of 33°.

32° = 1° 10' 4"

33° = 1° 11' 1"

2° 21' 5" the distance between the 31° and 33° parallel.

(B.)—GIVEN THE DEPARTURE, TO FIND THE DIFFERENCE OF LONGITUDE.

	0	1	2	3	4	5	6	7	8	9
0										
10	1°0154	1°0001	1°0006	1°0013	1°0026	1°0038	1°0055	1°0075	1°0098	1°0125
20	1°0642	1°0187	1°0224	1°0261	1°0306	1°0353	1°0403	1°0457	1°0514	1°0578
30	1°1547	1°0711	1°0785	1°0864	1°0946	1°1034	1°1126	1°1224	1°1326	1°1434
40	1°3054	1°1666	1°1792	1°1924	1°2062	1°2208	1°2361	1°2521	1°2690	1°2868
50	1°5557	1°3250	1°3456	1°3673	1°3902	1°4142	1°4395	1°4663	1°4945	1°5242
60	2°0000	1°5890	1°6242	1°6616	1°7013	1°7435	1°7883	1°8361	1°8871	1°9416
70	2°0238	2°0626	2°1301	2°2027	2°2812	2°3662	2°4586	2°5593	2°6695	2°7904
80	5°1587	3°0716	3°2361	3°4204	3°6280	3°8637	4°1337	4°4454	4°8097	5°2406
		6°3925	7°1856	8°2057	9°5664	11°475	14°334	19°108	28°653	57°307

USE OF THE TABLE.

Find in the Table the required parallel, the tens at the side and the units at the top: at their intersection will be found a quantity which, multiplied by the departure, gives the "diff. of longitude."

The departure from the meridian on the parallel of 34° was 25 miles—required the diff. of longitude.

$25' \times 1'00 = 30'00$ the diff. of longitude.

In the parallel of 60° the departure was 30 miles.

$30' \times 2 = 60$ miles, or 1 degree.

In the parallel of 35° N. the route was N. 40° W., 37 miles' distance.

Dis. Dep. Miles.

By Traverse Table, 40° course, 37 = $23'8 \times 1'21 = 29'03$ diff. of longitude.

Having thus obtained the distances between the required parallels divide the map into squares of 10 miles each way, and the map is ready for the projection of the route.

Conical Projection.

The conical projection or development is carried out thus: draw a straight line, A, B, to represent the central meridian of the intended map, and after having decided on the scale on which it is to be laid down, set off along this line A B from the point A scales of equal parts, for each 1° or 5° , as the size of the scale may admit. Also measure off from A towards B the distance $AC = 57.29578 \times \text{length of } 1^\circ \text{ in inches} \times \cot. \text{ lat. of A}$. Then with C as a centre and C A as a radius, describe an arc of a circle through the point A, representing the parallel of middle latitude, and divide it also into equal parts indicating 1° or 5° of longitude, each 1° of longitude being equal to 1° of lat. $\times \cos \text{ lat. of A}$; and from C draw the radiating lines, representing the meridian through the points laid off on A E, and also concentric circles through the points marked off on A B for each 1° or 5° for the parallels of latitude.

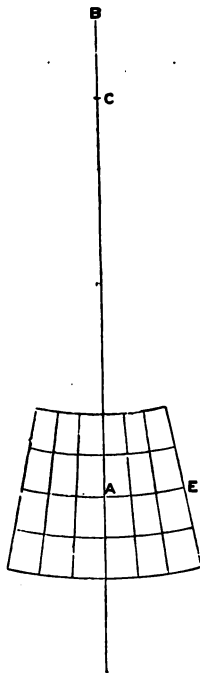

For the Rectangular Tangential Projection, see a pamphlet with Tables published by the Ordnance Survey Department, "On the construction and use of marginal sheet lines, for the uniform projection of maps in any part of the world."

17. REMARKS ON THE PLANE TABLE. By Lt.-Col. H. H. GODWIN-AUSTEN, F.R.S.

The *Plane Table* is one of the most useful instruments that an explorer

can take with him; not of the small-size constructed in this country, but one similar to those used in all extended survey operations in India. A Plane Table, 2 ft. 6 in. \times 2 ft., can be made exceedingly light, of good seasoned deal (panelled). The traveller should take two of this size, properly projected, with latitude and longitude on a scale of 8 or 10 miles to the inch, the former of which will embrace an area of 232×184 square miles, leaving an inch margin, although a Plane Table can be worked up to the extreme edge. On this scale I have worked successfully in Assam and the Naga Hills, and for fixing the position of peaks and hills, &c., at long distances it is invaluable. The tripod-stand is available for the other instruments, but this even is not required on all occasions, as a temporary tripod-stand can be made in a few minutes with three sticks tied together in the middle.* Even when the atmosphere is too hazy to see distant objects, or the traveller is passing through a forest-country, traverse work with prismatic compass can be projected upon the Plane Table, or the astronomical positions plotted in, and the Plane-Table work resumed as soon as circumstances permit. Better still than using a prismatic compass is to gum a fresh sheet of paper by its edges upon the Plane Table, and on some convenient scale, say 1 inch to the mile, the route can be sketched by back and forward rays, and setting the Plane Table by compass. This route-sketch can then be reduced and entered on the smaller scale Plane-Table section. A far wider area of country is sketched in by this method than by the use of the prismatic compass, an instrument which cramps the observer (especially a young one), so that the result of such surveys is generally a long line of route with nothing on either side, or that little confined to a mere mile or two. No error can creep into the Plane-Table work; whereas a few errors in recording prismatic compass bearings or distances can never be corrected, often never discovered, unless the ground is gone over again. The Plane-Table sketch is made on the spot; the country is put in as seen by the eye at the time, and when the traveller reaches camp, or his breakfasting-place, he can ink it in. If he be travelling in a dangerous country, where he may have to leave any of his

* When surveying the Bhutan Himalaya from Darjiling to Punakha, after losing my Plane-Table stand in the snow, crossing the Tegong-La, I worked on very well with such a stand for several weeks.

equipments, and make for some other place—not an unlikely contingency at times—he has only to keep a copy of his work on tracing-cloth, filling it in from time to time to carry in his pocket. During the year of the Indian Mutiny, when working in the Kashmir Territory, under circumstances that the survey was liable to be stopped at any moment, we followed this plan at Captain Montgomerie's advice, and, had anything happened, not a square mile of country finished would have been lost.

I do not think that the accuracy of Plane-Table work, or the rapidity with which it can be done, is known and appreciated in this country. To show its accuracy, I once tested it over about 80 miles in direct line on the scale of 4 miles to the inch, when carrying the triangulation across the Naga Hills from Assam into Manipur. I worked with a Plane Table, and fixed the points on it, at the same time sketching the country and it proved wonderfully exact when the triangles came to be computed, and the trigonometrical stations projected on it. It does not take longer to set up and commence working a Plane Table than to get out a prismatic compass. About four times, or more, the number of bearings can be taken with the former than with the latter in the same time; while the Plane-Table bearings have the merit of being absolutely true, and are all observed and projected together.

The different value and extent of the work in Afghanistan and at the Cape, executed during the late campaigns, shows conclusively the value of Plane-Table survey over the prismatic compass.

As a practical illustration—Working at the same time with an officer of the Quartermaster-General's Department on service, making a sketch of a fort and country round, my Plane Table Survey was finished and traced off when he had only begun the plotting in his tent. The run of the mountain-spurs around such a position could never have been entered on a plan produced from a Field-Book.

Saving of Labour and Time.

There is no measuring, no counting of paces or noting of time by a watch, no anxiety about the record, when Plane-Tabling. Between the intervals of setting up the board, the traveller can be botanizing, geologizing, or collecting objects of Natural History, and in the evening, when he comes in from his work of the day, he can sort and label his specimens and write up his journal, the greater part of which leisure time

he would have to give up to the plotting of the day's work, if done with Prismatic compass.

One of the objections often brought against the use of the Plane Table is its size and weight. This would be true if the traveller, with other things to carry, had to carry it himself. My experience in Asia, and what I know of Africa, where labour is, as a rule, plentiful and cheap, a Plane Table can always be carried by a native of the country, who at the same time would take the aneroid and boiling-point thermometers. In India the guides often carried the stand. It is seldom that a European is called on to carry anything in a tropical country. The Plane Table can be made as light as a gun or rifle; and, reduced in size (2 ft. \times 1½ ft.) together with a light tripod-stand, could be carried by any lad of 15 or 16, as was formerly the method of instruction at the R. M. C., Sandhurst.

Another objection raised is the possibility of its getting spoilt by wet. This is very easily avoided. It should slip easily into a waterproof bag, and if used in a very wet climate, such as the Khâsi Hills, a small waterproof sheet can be thrown over all. After working with it for years, and having sketched many thousand square miles of every kind of country, from dead level plains to the highest parts of the Himalaya, I never got one injured, and I never had one brought in spoilt by any of my assistants.

There is nothing about it to be broken, or get out of order, the sight-rule is of so simple a construction, any village blacksmith can make one should it get lost; and I once had to do this, cutting out the woodwork myself, and getting a native workman in the village to make the back and forward sights out of copper money. The stand is easily repaired. The traveller should take a spare clamping-screw, and a spare compass.

The compass-box should be of narrow oblong form, having a perfectly plane surface beneath, so as to lie flat on the board, not fixed to the Plane Table (as was done in the Sandhurst pattern). The needle should be at least 4 inches in length, and the north and south ends of the compass-box should have an arc graduated a few degrees on either side of the central line. At the first station where the Plane Table is set up and adjusted by the surrounding projected points or the first rays taken, the compass-box is to be placed on some convenient part of the Plane Table, and moved until the needle points exactly to the centre division of the graduated arc. A pencil line should then be drawn along one side of the compass-box

against which line it will always have to be laid when setting up the Plane Table by it.

But here I may call attention to another strong point in favour of the Plane Table, and that is that it can be used quite independently of the compass, in places where local attraction is great, and where, as I have often found, the magnetic needle is quite unreliable, throwing the Plane Table out many degrees, an error which would not be discovered if working with a prismatic compass. With three fixed points on the Plane Table, it can be fixed in its true position by interpolation.* But this method should be resorted to as little as possible; the Table should be set up, wherever possible, on rays taken from previously fixed stations.

On the method of Training a Traveller to use the Plane Table.

The best method of instruction for the traveller proceeding to any country who wishes to bring back good work, rapidly done, would be to give him say, in the South of England, some two counties to survey on 8 miles to the inch, or better, on 4 miles to inch, with no other instrument than such a Plane Table as used in the Indian Survey, a sight-rule and a compass. With the Lat. and Long. of two or three points projected on it—these should of course be commanding positions, 15 to 20 miles apart, visible from one another, he should be able to produce an excellent map of all the principal rivers, roads and coast-line. I give in detail the method to be followed, and we may select for example the counties of Surrey and Sussex, and suppose the traveller in this immediate neighbourhood, his camp at Dorking, and his line of route west towards Guildford and Farnham, should select as starting points Leith Hill and St. Martha's Chapel, about eight miles apart, which form an excellent base. We may assume that the Latitude and Longitude of each is already determined and projected on the Plane Table, or we may, supposing there is no time to do so, take from the scale of miles on the Plane Table a distance as near as can be estimated of the one from the other, and lay this down in a convenient part of the Plane Table with reference to the

* *Vide* Instructions for Topographical Surveying, by Sir Andrew Waugh, in the 'Manual of Surveying for India,' by Col. H. L. Thuillier, C.S.I., R.A. This paper may also be read with advantage. 'Military Map Making,' by Captain Holdich, R.E., Jour. Roy. U.S. Inst., vol. xxii., 1878, p. 977.

area to be mapped, indicating each station by a pin-hole with a small circle drawn round it, which should be inked in, and I should recommend, as a good scale for a beginner, the $\frac{1}{2}$ inch or 2 miles = 1 inch, but for actual work in the field 4 miles = 1 inch is the best scale. This will take in 2668 square miles, with an inch margin all round, i.e. 58 miles \times 46 miles. Proceeding to Leith Hill the edge of the sight-rule is laid upon this baseline and directed to St. Martha's Chapel, selecting some part of the top of the hill through the telescope, where the Plane Table can be set up in the most advantageous spot to see the stations that are to be afterwards laid down on the Plane Table from thence. When this spot is accurately intersected by the sight-rule, clamp the Plane Table, and then select the next main stations of observation for the Plane-Table triangulation. Thus the most conspicuous points for further extension will be Hind Head, Hascombe Hill, Booker's Tower at Guildford, a point on the Chalk Downs above Wotton, Box Hill, and Reigate Beeches, and on the far South Downs three or four conspicuous points are visible near Worthing. Having most carefully taken these rays, place the compass near the side of the Plane Table, and when steady, pointing due north and south, draw a line round the box and record the name of the station, this should be repeated two or three times to see if the needle always returns to the same point. The compass should always be tested at all principal Plane-Table stations, and any variation of the compass can thus be detected. Rays must then be taken to church towers, villages, conspicuous trees, &c., and their names, as taken from the guide, recorded in the Field Book in consecutive series, the numbers being written on the Plane Table across the ray—thus $\frac{2}{4}$. Only a portion of the ray should be drawn, about half an inch or an inch in length, at the estimated distance, of the object intersected; for it is very easy to extend such a line afterwards if the estimate be wrong. Symbols are very useful upon these pencil lines: thus, a circle for top of a hill, = for a village, + church, \square fort, &c., a hill-top or a mountain-peak should have its outline sketched on the Plane Table, its apex on the ray, which will aid the memory very greatly when it is seen again from a second station. Before leaving Dorking the traveller would ascend Box Hill, and, setting his Plane Table by the ray he took from Leith Hill, he would fix the selected station above Reigate, and the intermediate points and clumps of trees on the same chalk ridge, and he would get in a number of villages lying to the south

and south-east, which would give him further information, the source of the River Mole, and a great deal of the country for 8 or 10 miles; he would even get approximately the position of the South Downs on the coast. On his march to the next camp, near Albury, he would ascend to the points he had selected above Wotton, and thence he would get a great deal of detail in the valley he was about to pass through, and, as now from any open point on the line of his route, wherever he could see the tower on Leith Hill, St. Martha's and Box Hill, he would set up the Plane Table by compass and get his position by the intersection of rays from those points. Should the Plane Table not be in true azimuth, the interpolated rays will form a small triangle, and the board must be very slightly moved until they all meet in one point. He will have fixed by this time Ewhurst Windmill, which will give him another good point. From Albury he would go at once to the top of St. Martha's, the western end of his base, and, setting up the Plane Table by Leith Hill, intersect Hind Head and Wotton stations and Hascombe Hill, and select his forward stations on the Hog's Back, near Puttenham, Crooksbury Hill, Cæsar's Camp, and on the north-west one on the Fox Hills, and St. George's Hill near Weybridge, he will get good intersections to the rays on the South Downs from a base of nearly 10 miles; he will get a multitude of rays on his Plane Table, which he will intersect for his next forward station on the Hog's Back, and when he descends on to the low ground he will always be able to determine his position from Leith Hill, Hind Head, St. Martha's, &c. It is hardly necessary to add that, from Hind Head and some point on Chobham Ridges and Cæsar's Camp, he will be able to extend this Plane-Table triangulation across Hampshire into Wiltshire, and, having worked up towards the edges of his board, he has only to project some of the stations upon his second Plane Table and he can then carry his work with very great accuracy into Devon and Cornwall, and, if he eventually got down south by the coast through the Weald, he would always be able to fix his position from the points on the north. On the South Downs he will have rays that will set his Plane Table without recourse to compass, and sketch in the whole line of the coast. Supposing his original base to be not absolutely accurate, he can on some convenient level ground fix the ends of a base and measure the same, or obtain by astronomical observations the Latitude and Longitude of two or three positions.

In carrying out this kind of work care alone is necessary, and in some very small points. The edge of the sight-rule must be very true and parallel to the line of the back and forward sights. These again must be perpendicular, so that the hair in the front sight must intersect a distant object both at the top and bottom, the collimation error is then got rid of. The table must be set up level. The pencil must be sharp, and held perpendicularly, so that the ray drawn is at the same distance from the edge of the sight-rule as the station dot. If this is not attended to of course a good deal of error may creep into extended work. The triangles should be as symmetrical as possible, the angles not less than 30° or much over 90° .

Plane Tables used in the Indian Survey Department.

A. View of under part of the Plane Table, showing the brass plate in the centre with socket-screw, counter sunk and fixed by screws.

The Board should be one inch thick, of well seasoned wood—deal is the lightest—two bars are attached across the grain to prevent warping, fixed by one screw in the middle, with two at each end working in a long hole so as to allow of expansion and contraction. The screws should be bevelled at the shoulder, and a slip of brass should be placed between the shoulders of the screw and the wood to prevent counter-sinking.

B. View from above, as placed on the tripod-stand, with compass box in position. The stand is similar to those used for the Photographic Camera, having folding legs and a triangular top of wood with a hole in centre for the clamping-screw C to pass through. A solid tripod-stand, as shown in E, is however the best, and can be made very light and strong, and it can be used when observing with the Theodolite.

D Is the sight-rule—as long as the Plane Table—and packs inside the waterproof case. The back sight has a narrow slit cut in it; the fore sight has a wider slit, with two small holes above and below to receive the horsehair or fine wire, which is easily adjusted by little pegs of wood.

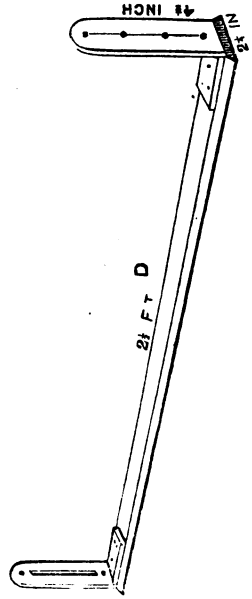
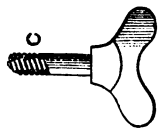
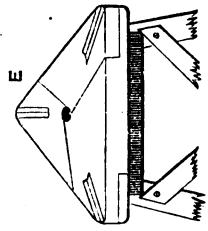
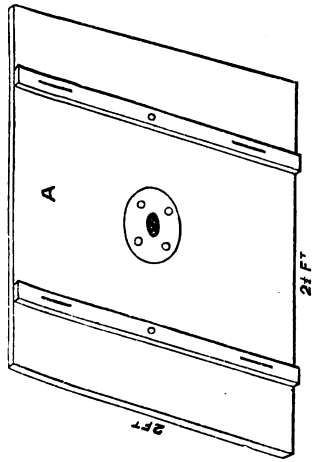
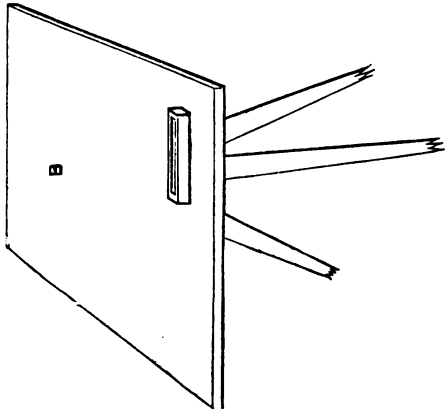

THE PLANE TABLE.

HINTS TO TRAVELLERS.

FORM FOR FIELD BOOK.

Date.	Number on Plane Table.	NAME OF PLACE.	Number of Houses.	Lat.		Long.		Time.	Observations for Altitude.							Deducted Height.	REMARKS.	
				°	'	°	'		No. of B. P. Ther.	Rolling Point Ther.	No. of Ther.	Air Ther.	Thermom.	No. of Aneroid.	Aneroid or Barometer.			
1864.	47	Am Mochu	°	"	°	"	15	206.60	{ River from Chumbi and Plug Rhi.
5th Feb.	48	Mochu Bridge	..	°	..	°	..	3 P.M.	6	206.18	4	65	38.49	..	
	49	Waterfall	°	..	°	11	206.20	
	50	Mochu	°	..	°	{ Stream joining Am Mo- chu.
	51	Bèso	°	..	°	Peak high to south.
6th Feb.	52	Tsanghè Camp	..	°	..	°	..	4 P.M.	15	202.6	4	50.5	

18. TABLE FOR ROUGH TRIANGULATION WITHOUT THE USUAL INSTRUMENTS AND WITHOUT CALCULATION. By FRANCIS GALTON, F.R.S.

A traveller may ascertain the breadth of a river, or that of a valley, or the distance of any object on either side of his line of march, by taking about 60 additional paces and by making a single reference to the Table on page 118.

Suppose he is travelling from A to Z (Fig. I., p. 118), and wishes to learn the distance from A to C; and, it may be, also the angle A. Let him as follows (referring now to Fig. II.).

1. Leave a mark at A. 2. Walk 10 paces towards Z, and make a mark, calling the place *m*. 3. Walk back to A. 4. Walk 10 paces towards C. 5. Walk to *m*, counting the paces to the nearest half-pace. (This gives the measurement of the line *a* (Fig. I.), which is the chord of the angle A, to radius 10.) 6. Walk 80 paces towards Z; make a mark, calling the place *n*. 7. Walk 10 paces towards Z, calling the place B; this completes 100 paces from A. 8. Walk 10 paces towards C. 9. Walk to *n*, counting the paces to the nearest half-pace. (This gives the line *b*, which is the chord of the angle B, to radius 10.)

Now enter the Table with *a* at the side and *b* at the top, and read off the distance AC, and the Angle A if also required.

If the Table be entered with *b* at the side and *a* at the top, it gives BC (and B).

Of course the units need not be paces: feet, furlongs, miles, hours' journey, or anything else will do as well; and the units of AB need not be the same as those of *a* and *b*. Also any multiple or divisor of 100 for AB may be used, if the tabular number be similarly multiplied.

EXAMPLES.

<i>a</i> (in paces).	<i>b</i> (in paces).	A B.	A C.	Angle A.	B C	Angle B.
5	6½	100 paces	67 paces	0 / 28 58	53 paces	0 / 37 56
5	6½	50 miles	33½ miles	28 58	26½ miles	37 56
10½	7	100 paces	68 paces	63 22	92 paces	41 0
10½	7	1000 paces	680 paces	63 22	920 paces	41 0

Particular care must be taken to walk in a straight line from A to B. It will surprise most people, on looking back at their track, to see how

TABLE for Rough Triangulation without the usual Instruments and without Calculation. By FRANCIS GALTON, F.R.S.

	ANGLE.	5	6	7	8	9	10	11	12	13	14
5	0 28 31	60 58 55	67 65 62	73 72 69	78 78 74	84 84 81	89 90 87	95 96 93	101 101 100	109 112 107	118 122 116
6	0 34 37	57 56 53	64 63 60	71 70 67	77 77 74	84 84 80	90 91 87	97 99 95	105 108 103	115 119 113	126 132 125
7	0 41 44	52 51 51	59 62 58	66 70 66	73 77 73	81 85 81	88 92 89	96 101 98	106 111 109	123 128 114	139 146 128
8	0 47 50	50 49 53	58 62 57	66 70 65	74 78 74	82 86 83	91 98 92	101 106 103	112 118 116	134 141 141	156 153
9	0 53 56	49 49 51	57 62 57	66 71 66	75 81 76	84 89 86	94 100 97	106 113 110	121 129 126	139 150 136	
10	0 60 63	48 48 53	57 62 58	67 72 68	77 82 78	88 94 90	100 107 104	115 123 120	133 145 130	147	
11	0 66 70	49 49 54	58 64 60	69 74 70	80 86 83	93 100 97	108 117 113	127 138 135	147		
12	0 73 77	50 50 56	60 66 62	72 79 75	85 93 89	101 110 106	117 131 141				
13	0 81 84	52 57 53	64 70 66	77 85 81	93 103 99	113 125 121	138 155 150				
14	0 88 92	55 57 65	69 77 73	85 95 91	106 118 114	132 148 145					
15	0 97 101	60 64 73	77 87 83	99 110 108	126 143 141						
16	0 106 111	60 79 88	90 105 103	121 140 141							

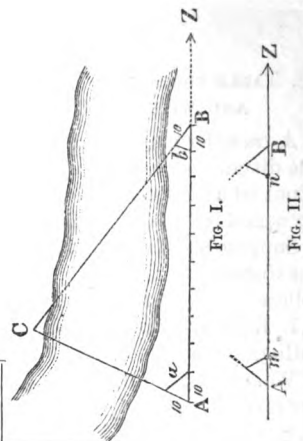

To find A C and angle A :—Enter with α at the side and b at the top.

To find B C and angle B :—Enter with b at the side and α at the top.

curved it has been, and how far Bn is from pointing truly towards A. It is important to sight some distant object in a line with Z when walking towards it.

The triangle ABC must be so contrived that none of its angles are less than 30° , or the chords of the angles at A and B will not be found in the Table. These cases cease to give reliable results when the measurements are rudely made, and have therefore been omitted.

Should a traveller have no Tables by him, he can always *protract* his measurements to a scale on a sheet of paper, or even on the ground, and so solve his problem. If real accuracy be aimed at, it is clear that it may be obtained by careful measurements of the base and chords, combined with a rigorous calculation, as was first suggested by Sir George Everest, formerly Surveyor-General of India. (See 'Journ. R. Geog. Soc.,' 1860, p. 122.)

19. MEASUREMENT OF THE NUMBER OF CUBIC FEET OF WATER CONVEYED BY A RIVER IN EACH SECOND.

The data required are—the area of the river section and the average velocity of the whole of the current. All that a traveller is likely to obtain, without special equipment, is the area of the river-section and the average velocity of the *surface* of the current, which is less than that of its entire body, owing to frictional retardation at the bottom.

To make the necessary measurements, choose a place where the river runs steadily in a straight and deep channel, and where a boat can be had. Prepare a few floats, of dry bushes with paper flags, and be assured they will act. Post an assistant on the river-bank, at a measured distance, of about half the estimated width of the river, down stream, in face of a well-marked object. Row across stream in a straight line, keeping two objects on a line in order to maintain your course. Sound at intervals from shore to shore, fixing your position on each occasion, by a sextant-angle between your starting-place and your assistant's station, and throw the floats overboard, signalling to your assistant when you do so, that he may note the interval that elapses before they severally arrive opposite to him. Take an angle from the opposite shore, to give the breadth of the river.

To make the calculation approximately, protract the section of the river on a paper ruled to scale in square feet, and count the number of squares in the area of the section. Multiply this by the number of feet between you and the assistant, and divide by the number of seconds that the floats occupied, on an average, in reaching him.

Important rivers should always be measured above and below their confluence; for it settles the question of their relative sizes, and throws great light on the rainfall over their respective basins. The sectional area at the time of highest water, as shown by marks on the banks, and the slope of the bed ought also to be ascertained.

EXAMPLE.

DISTANCE FROM SHORE	Start- ing- place.									Oppo- site Shore.	
Whence the boat started, mea- sured in feet}	o	90	160	240	330	420	500	600	700	780	
Depth at those distances mea- sured in feet}	o	2	3½	4	4	5½	7	6½	3½	o	
Time required for float to drift opposite to assistant, mea- sured in seconds}	—	48	50	40	33	29	27	30	50	—	Ave- rage. 38·4

Distance of assistant, in feet, 150.

By protracting the data on the first two lines, on ruled paper as described above, it will be found that the area of the section is 3260 feet or thereabouts; this, multiplied into 150, gives 489,000 cubic feet of water as the contents of the river at any given moment between the line of soundings and the assistant. As this amount passes by in 38·4 seconds, the number of cubic feet per second is the former number divided by the latter, which gives 12,734.

It must be distinctly understood that this number is only roughly approximative, and that it is excessive. However, with the above data, an engineer would be able to make a somewhat better calculation. In the meanwhile, the traveller might consider the flow of the river in question to be between 10,000 and 13,000 feet per second.

20. ON OBSERVATIONS WITH THEODOLITES OR ALTAZIMUTH INSTRUMENTS,
By Lieut.-General J. T. WALKER, C.B., F.R.S., R.E., Surveyor General of
India.

In the opening pages of these Hints, lists of instruments have been given which travellers of little experience are recommended to provide themselves with, and the sextant has been more particularly recommended, as the traveller will have opportunities of practising with it under the tuition of the officers of the ship which is conveying him to his destination. The suitability of this instrument for observations, both on land and sea, is thus a great advantage for any person who has not had an opportunity of learning the use of his instruments before starting on his expedition; and should he not have a sufficient knowledge of the methods of reducing the observations and calculating the results, he will find the simplest and easiest rules for his guidance in the several works on navigation, which are specially written for the reduction of observations with sextants by persons possessing little or no knowledge of the principles on which the rules are based. The inexperienced traveller can scarcely be expected to attain much accuracy in his observations and reductions, but should he explore unknown regions, he may be able to acquire valuable information, the immediate interest of which may be very considerable; but his work will necessarily be of a preliminary nature, and be liable to be largely corrected, or altogether superseded, by the operations of subsequent explorers.

But the extent of the regions of *terra incognita* in which inexperienced travellers can operate with the greatest advantage is constantly becoming more and more narrowed and diminished, and geographical science now-a-days frequently requires that the rough outlines which have hitherto sufficed for her purposes, should not only be amplified and filled in, but rectified by more exact and reliable observations. The traveller must, in such cases, be provided with an instrument of greater capabilities than the sextant, and he should have thoroughly learnt the use of this instrument and the method of reducing the several kinds of observations which may be made with it before he commences operations. If he has no better instruments nor greater skill than his predecessors, his results may differ widely from theirs, but they will not be more worthy of confidence, and, while causing much perplexity and inconvenience to geographers,

they will only exhibit with certainty the degree of uncertainty that is still attached to the problem under investigation.

An altazimuth instrument—or a theodolite possessing a complete vertical circle as well as a horizontal circle—is in many respects superior to a sextant. 1st, it measures horizontal angles directly, thus avoiding the labour of reducing oblique angles to the horizon; and a round of several angles can be measured with far less trouble than with the sextant. 2ndly, it measures small vertical angles of elevation or depression of objects which frequently could not be seen by reflection from a mercurial horizon for the measurement of the double angle by a sextant. 3rdly, its telescopic power is usually far higher than that of a sextant. 4thly, it may be so manipulated as to eliminate the effects—without in the first instance ascertaining the magnitudes—of certain constant instrumental errors, such as excentricity, collimation, and index errors. And 5thly, the influence of graduation errors may—when great accuracy is required—be reduced to a very considerable extent by systematic changes of the zero settings of the horizontal circle.

The disadvantages of the altazimuth instrument as compared with the sextant are its greater cost and bulk and weight; but in many instances these disadvantages will be more than counterbalanced by its superior capabilities.

Messrs. Troughton and Simms have favoured me with the following details regarding the cost, weight, and telescopic powers of these instruments as constructed by themselves:—

Instrument.	Weight of with Box.	Weight of Stand.	Price.	Telescopic Powers.	Readings of Verniers.	Details.
7-inch (radius) sextant Artificial horizon ..	lbs. 7 5 to 10	lbs.	£ s. d. 12 0 0	5 to 10	10"	
4-inch (diameter) tran- sit theodolite}	13½	9	23 0 0	9 " 12	1'	{ Without transit axis level, and lamp. { With transit axis level, and lamp. Do.
5-inch " "	25	10	32 10 0	12 " 15	30"	
6-inch " "	31	10	40 0 0	12 " 18	20"	

The Messrs. Casella construct certain very light and cheap altazimuth instruments, with 3-inch circles, power 5, weight with box 4 lbs., weight of stand 3½ lbs. divided to 1', price under 20/.

For astronomical observations the sextant is decidedly preferable to very small altazimuth instruments, but the latter are to be preferred for the measurement of horizontal angles and small elevations or depressions.

The traveller must necessarily adapt his equipment to his requirements and the facilities he will possess for carrying his instruments about. He may find it convenient to employ a sextant for astronomical, and a very small light altazimuth for terrestrial observations. But, whenever practicable, an altazimuth of moderate size, which may be used as a universal instrument, would undoubtedly be the most convenient and satisfactory.

The instrument which I would recommend for astronomical explorations, as being well adapted for astronomical and for terrestrial observations and not very bulky, is the 6-inch transit theodolite by Messrs. Troughton and Simms: several of these have been used in explorations connected with the operations of the Great Trigonometrical Survey of India, and have given great satisfaction, being sufficiently accurate for all desirable purposes, and not too heavy to be easily carried. These instruments are adapted for determinations of time and longitude by the method of zenith distances, and also by that of meridional transits; the former being best suited for the traveller when he can only devote a few hours to the operations, the latter when he is halting for a long time at one place: the two methods lead to strictly independent results, so that when both are employed they serve to check each other. The instrument is also well suited for latitude and azimuth observations; in fact it can be employed in any of the investigations which an explorer may have to undertake by means of astronomical observations. On the other hand, as an instrument for the measurement of terrestrial angles, whether horizontal or vertical, it is very valuable, and far superior to any sextant, not only being more conveniently manipulated, but possessing telescopic powers which permit of the detection and identification of objects that would often be sought for in vain with a sextant.

Trigonometrical operations are, as a rule, far simpler and more easily reduced, and lead to more accurate results than astronomical observations. A continuous triangulation, or a traverse with measured angles and distances, is necessarily impossible when the explorer has to pass through a country very rapidly; but he may frequently remain for several days at one place, and may then have opportunities of greatly extending the scope of his operations by executing a triangulation. Suppose him to be

in view of a range of hills which he may not have an opportunity of exploring, distant say 50 to 100 miles; he may have already endeavoured on his line of march to fix points on the range by bearings, but from the absence of prominent landmarks has found a difficulty in identifying the points observed, and thinks he may have mistaken one hill for another in consequence of their changes in appearance as viewed from positions at some distance apart. If, during his few days' halt, he can manage to do a little triangulation, he may fix the general outlines of the entire range relatively to his halting-place with very respectable accuracy. He has first to measure a base and determine by triangulation the positions of three stations lying in a direction nearly parallel to that of the range, and at distances of 2 to 5 miles apart; then at each of these stations he must measure the angles between the other stations and a series of points on the entire length of the range; * though no very prominent landmarks may be visible, still the telescope will show a number of objects—trees, masses of rock, and peculiarities of the ground—sufficiently clearly to permit of their being recognised at stations of observation which are so close to each other; and though the triangles will be very acute-angled, the angles may easily be measured with sufficient accuracy to give the distances of the points on the ranges from the stations of observation with a small percentage of error, whenever the marks are fairly identified; and as there will be two triangles to each point, and, therefore, double values

* He should make a sketch of the outline of the range in his book of observations; and as he will probably be unable to ascertain the names of the hill summits at such a distance from them, and many of them may have no names, he had better number them in the order in which they are observed, and refer to them always by these numbers, until he can confidently replace a number by a name. Exaggerated sketches of the outlines of the objects intersected by the telescope are frequently of use to facilitate identification on proceeding to the next station.

The positions of places situated within or beyond the range of hills, which are invisible to the traveller, but are known to his native guides and assistants, may frequently be determined by making a native point the theodolite, as a gun, in the direction of the place, and state its distance beyond or on this side of the range. The guides will often be found to possess a remarkable knowledge of locality, and I have frequently known the independent pointings of different men towards distant invisible objects to coincide together very closely, as was shown by the readings of the azimuthal circle.

of the side common to both triangles, any mistakes—whether of identity, or of reading, or calculation—will be at once shown up.

The 6-inch transit theodolites of the Indian Survey which have been used in military expeditions and explorations are specially provided with a pair of micrometers in the eye-piece of the telescope, for the purpose of measuring small angles, and more particularly those subtended by objects of known dimensions, by means of which the distance between the object and the observer is readily deduced. The system of micrometers is movable through an angle of 90° , so as to permit of the measurement of either a horizontal or a vertical object. With the aid of this appliance, the instrument can be employed in carrying on a traverse without using any direct measuring apparatus, such as a chain or perambulator, the distances to the back and forward stations being determined by measuring the angles subtended by poles of known length, which are set up at the stations. In hilly and broken ground, in crossing rivers or other obstacles, and generally wherever a direct measurement is impracticable, this method of procedure is most convenient. It was adopted by Captain Carter, R.E., in his survey—with one of these instruments—of the line of country passed over by the British army in the Abyssinian expedition. Captain Carter carried a traverse from Adigerat to Magdala, a distance of nearly 300 miles, without any break of continuity, the daily rate of progress averaging 5 miles, and being occasionally as much as 8 miles. The difference of latitude between the origin and terminus as determined from these operations only differed by about a quarter of a mile from the value determined astronomically.

Whenever a halt occurred in the movements of the army, the instrument was used as a theodolite in triangulating, to fix the positions of all hills and other prominent objects around the halting-place; it was also used for various astronomical observations.*

* These instruments being furnished with a pair of micrometers, which can be used either horizontally or vertically, are all the more valuable for astronomical observations; for the micrometers give two additional wires over which the stars may be observed, and these wires can be set at pleasure to any distance from the fixed wires in the diaphragm which may be best suited to the rate of movement of the star. For pairs of observations—face right and face left—no reductions to the centre wire are necessary; and thus greater accuracy is obtained with very slight additional trouble of observing, and still less of computing.

Remarks on the Manipulation of Altazimuth Instruments.

Observations with these instruments should always be made in pairs, with the face of the vertical circle alternately to the right and left of the observer. Thus, supposing that in the first observation, or round of observations, the face of that circle is to the right of the observer, the telescope should be immediately afterwards moved through 180° in azimuth, and turned over in altitude, which will bring the face of the circle to the left of the observer, and then a second observation, or round of observations, should be taken; the mean of the two measures, face right and face left, will be free from collimation, index, and other instrumental errors.

In measuring horizontal angles between objects of nearly the same altitude, as landmarks not much above or below the horizon, a change of face is not absolutely necessary, and may be dispensed with if the observer is hurried; but when such angles are measured between objects of very different altitudes—as a terrestrial referring mark and a star—and whenever altitudes are measured, whether of terrestrial or celestial objects, the observations should invariably be taken in both positions, alternately “face right” and “face left,” and the final result deduced from the mean, in order that the instrumental errors may be eliminated. There is no necessity to determine the magnitude of these errors, as in the sextant; in an instrument which has to travel far over bad ground the adjustments are liable to alter from time to time, but they are not likely to alter in the interval between two consecutive observations, and the errors arising therefrom will be eliminated in the mean of the pair.

In what follows regarding *astronomical* observations with these instruments, a complete observation will be understood to imply the mean of a pair of observations, one with face right, the other with face left, taken continuously without any considerable pause between them, the entire operation being considered as one observation.

Determinations of Time, Azimuth, Latitude and Longitude, with a Transit Theodolite.

The transit theodolite may be employed either as a transit instrument or as an altazimuthal instrument; it is adapted for all astronomical observations, excepting those of “lunar distances,” which can only be

performed by a sextant or a reflecting circle, and occultations, which require larger telescopes.

Thus a description of each of the various kinds of observations which can be made with transit and altazimuth instruments, with full details of the methods to be employed in the corresponding reductions, would fill a volume, and be much more than is required for a book which merely purports to give hints to travellers. Those who wish to learn full particulars of each of the several methods of observation, and of the reductions, cannot do better than study Chauvenet's 'Spherical and Practical Astronomy,' which is one of the most valuable works on the subject in the English language: it gives ample instructions for observations of all kinds, the rudest and most hurried, as well as the most refined and elaborate, and it supplies corresponding formulæ—approximate as well as rigorous—for the reduction of the observations.

As these Hints are merely intended to indicate the simplest and most expeditious methods by which a traveller who is able to carry a suitable altazimuthal instrument about with him can take the astronomical observations which are essentially necessary for his geographical explorations, they will be restricted to determinations of time, latitude and longitude, by the measurement of zenith distances, and of azimuths by horizontal angles; formulæ—some approximate but all sufficiently rigorous for the purpose, and adapted mostly from Chauvenet—will also be given, for the reduction of the observations.

Latitude Observations, the time being unknown.—The instrument being duly levelled and brought approximately into the meridian, set the telescope on any star—or on the sun—when approaching culmination, and follow it until the maximum altitude is reached; take the zenith-distance reading on the vertical circle, change face quickly, and make a second observation; the mean of the two will be a "complete observation" of zenith distance. Two or three pairs of observations may be taken to circumpolar stars, as their zenith distances will not alter sensibly during an interval of a quarter to half an hour; for other stars the observations should be restricted to one pair, and stars should not be observed when within 25° of the zenith. A single pair of observations with the 6" transit theodolite should give a determination within $20''$ of the truth; greater accuracy may be obtained by observing additional stars, more particularly when the stars are selected so as to form pairs of nearly equal distance from the zenith, north and south.

Latitude Observations, the time being known.—(1.) Observe the zenith distance of the Pole-star in any position, and reduce to the meridian by the tables in the ‘Nautical Almanac.’

(2.) Take circum-meridian observations of the zenith distance of any star, alternately face right and face left, and note the time of each observation; compute the reduction of the zenith distance at the time of observation to the distance on the meridian, and take the mean of the reduced results as the determination of the meridional zenith distance. Three or four pairs of observations may generally be made in succession to the same star; but the nearer the star is to the zenith the more accurately should the times be known—it is not desirable, therefore, to observe stars within 10° of the zenith. Here, too, pairs of north and south stars of nearly equal zenith distance will give the best results.

Time.—Take pairs of observations of the zenith distance of a star, noting the chronometer time of each, and adopt the mean of the times as the time corresponding to the mean zenith distance, with which, the latitude of the place, and the star’s declination, the star’s hour angle must be computed by either of the well-known formulæ: thus the local time and the chronometer error will be determined. For these observations stars are most favourably situated which are easterly or westerly, and not very near either to the horizon or to the meridian; and greatest accuracy is obtained when two stars are observed at nearly the same altitude, one to the east, the other to the west. With a pair of observations the chronometer error should be determined within 1 second when a 6" transit theodolite* is used.

Longitude.—Take pairs of observations of zenith distance, face right and face left, on a star, for the determination of local time and chronometer error; then take other pairs of observations of zenith distance on the moon; in each instance adopt the mean of the chronometer times as the time of the “complete observation” of zenith distance. Both moon and star should be as nearly easterly or westerly as possible, and always materially nearer the prime vertical than the meridian; and they should

* At a trial of one of these instruments for the Indian Survey, the results of six pairs of observations on east and west stars fell within an extreme range of 0.4 of a second of time; the stars were, however, observed on the wires of the two micrometers, as well as on the fixed wire of the diaphragm. (See footnote, page 125.)

be sufficiently above the horizon to prevent the observations being sensibly affected by errors of refraction. The operations should commence and close with star observations, for time and chronometer rate. The effect of instrumental errors will probably be sensibly reduced when the star and the moon are on the same side of the meridian, and nearly at the same zenith distance. If time permits, observation should be taken both east and west of the meridian; and both before and after full moon.

The best time for observing the moon is when the direction of the resultant of her motion in right ascension and declination is pointing towards the zenith of the observer.

The sidereal time when this occurs may be readily found, graphically by drawing on a chart of the heavens a tangent to the moon's orbit, at some point near its mean position on any given day, and producing the tangent to cut the declination circle passing through the observer's zenith; then the hour circle passing through the point of intersection gives the sidereal time of observation. It will ordinarily suffice to drop a perpendicular from the point indicating the moon's position on the ecliptic, and draw through that point a line at right angles with the perpendicular to cut the declination circle. It will be found that the most favourable time occurs when the moon is near the prime vertical, and the least favourable when she is near the meridian. In north latitudes the moon is most favourably situated when west of the meridian if her motion in declination is from south to north, and when east of the meridian if the motion in declination is from north to south.

A few observations taken daily on several days are preferable to several observations on a single day.

Azimuth, time and latitude being unknown.—Observe the angles between a referring mark * and a star, when the star is at the same altitude east

* A good referring mark may be made of a cross with a hole of $\frac{1}{4}$ to $\frac{1}{2}$ an inch in diameter in the centre, to which observations can be taken by day and by night, being rendered visible at night by a bull's-eye lantern placed behind the hole and directed to the observer. The stem of the cross should be vertical, and driven firmly into the ground. The distance from the station of observation should be at least half a mile, and the station should be marked by a pin driven into the ground, over which the theodolite must be carefully centered whenever set up for horizontal observations.

and west of the meridian; several pairs of observations may be taken at consecutive altitudes, half with face right and half with face left. Or the angles may be measured between a referring mark and a circumpolar star at the times of its maximum elongations east and west. The mean of the two angles at opposite positions gives the angle between the star and the meridian, and thence the azimuth of the referring mark, without any calculations whatever. In the first case, however, an interval of several hours must be allowed to elapse between the observations east and west; and as twelve hours must necessarily elapse between the opposite elongations of a circumpolar star, few stars will ordinarily be visible at both elongations.

It may therefore be desirable to adopt a third and more expeditious method, as follows:—Measure the angles between the referring mark and *two* circumpolar stars at their respective elongations, selecting stars which are nearly in opposition or nearly in conjunction, and will attain their maximum elongations at nearly the same time, that the observations may be completed quickly; then, with the observed value of the angle between the stars, and the given declinations of the stars, the azimuths of both may be readily computed, as shown at page 135.

Azimuths, latitude being known.—Observe the angle between the referring mark and a circumpolar star at maximum elongation, and compute the azimuth of the star. To stars near the pole two or three pairs of observations, face left and face right, may be taken before the star moves sensibly from the position of maximum elongation.

Azimuth, latitude and time being known.—Any star may be observed in any position, but the best results will be obtained when a circumpolar star is observed at a short distance from the elongation; the angle between the position of the star at the observation and at the elongation may be computed by the formulæ at page 135.

Azimuth, latitude and star's altitude being known.—Observe the angle between the referring mark and an east or west star, and measure the vertical angle of the star simultaneously by observing the star at the intersection of the horizontal and vertical wires of the theodolite, change face and repeat the measures of the horizontal and vertical angles, taking the mean of each as a "complete observation." The star should not be at a high altitude; it should be situated near the prime vertical, and rather on the side towards the apparent pole than on the opposite side.

This method is extensively practised in the Indian Surveys for the determination of verificatory azimuths for revenue surveys, for which it has been found more convenient than any other method. The observations are usually taken between sunset and dark, when there is sufficient light to dispense with lamps for illuminating the wires of the telescope or indicating the referring mark; a lamp to illuminate the graduations of the circles is, however, generally necessary.

General Remarks.—The observed zenith distances should always be corrected for refraction; barometer and thermometer readings should, therefore, be taken during the observations, for the better determination of the refraction. When no barometer is at hand, the height of the station of observation should be given, as deduced by the boiling point or otherwise, or even approximately estimated. It may be well to remember that in determining latitude, errors of refraction may be eliminated by observing pairs of north and south stars of the same zenith distance.

Formulae and Examples.

Latitude by Circum-meridian Observations of a Star.

Let ϕ be the true latitude, ζ the true zenith distance on the meridian, ζ_0 the observed zenith distance corrected for refraction, δ the declination of the star,* ϕ_0 an approximate value of ϕ , $= \delta \pm \zeta_0$, t the hour angle of the star.

$$\text{Put } A = \frac{\cos \phi_0 \cos \delta}{\sin \zeta_0} \text{ and } m = \frac{2}{\sin 1''} \sin^2 \frac{1}{2} t.$$

$$\text{Then } \zeta = \zeta_0 - A m, \text{ and } \phi = \delta \pm \zeta.$$

The values of m are tabulated in Chauvenet's 'Astronomy.'
 Alternative forms of m , } $m = \text{cosec } 1'' \text{ versin } t.$
 adapted for various } $= .00055 t^2$, when t is given in seconds of time.
 logarithmic tables. } $= 2 t^2$ nearly, ,, ,, minutes ,,
 Supposing n observations to be taken, then, since A is constant,

$$\zeta = \zeta_0 - A \frac{m_1 + m_2 + \dots + m_n}{n}.$$

* When the sun is observed, the declination corresponding to the mean of the times of observation should be used.

Example.—CIRCUM-MERIDIAN OBSERVATIONS FOR LATITUDE TO β URSÆ MINORIS,
NORTH OF THE ZENITH.

Face.	Circle Readings.*	Mean Zenith Distances of Pairs of Observations.	Chronometer.			t , in Minutes of Time.	t^2 .	Data.
			H.	M.	S.			
Left	Alt. $\begin{matrix} 0 & ' & '' \\ 54 & 10 & 20 \end{matrix}$	$\begin{matrix} 0 & ' & '' \\ 35 & 47 & 38 \end{matrix}$	14	45	47	7.2	52	R. of Star .. H. M. S. 14 51 14
Right	Z. D. $\begin{matrix} 35 & 45 & 35 \end{matrix}$	$\begin{matrix} 35 & 47 & 38 \end{matrix}$	47	1		6.0	36	Chron. Error + 1 46
Left	Alt. $\begin{matrix} 35 & 45 & 0 \end{matrix}$	$\begin{matrix} 35 & 47 & 5 \end{matrix}$	48	55		4.1	17	Chron. Time of Transit } 14 53 0
Right	Z. D. $\begin{matrix} 54 & 11 & 0 \end{matrix}$	$\begin{matrix} 35 & 47 & 8 \end{matrix}$	51	30		1.5	2	
Left	Alt. $\begin{matrix} 35 & 45 & 30 \end{matrix}$	$\begin{matrix} 35 & 47 & 25 \end{matrix}$	54	37		1.6	3	δ = 74 46 37 ζ_0 = 35 48 5
Right	Z. D. $\begin{matrix} 35 & 45 & 50 \end{matrix}$	$\begin{matrix} 35 & 47 & 40 \end{matrix}$	56	22		3.4	12	
Left	Alt. $\begin{matrix} 54 & 10 & 30 \end{matrix}$	$\begin{matrix} 35 & 47 & 40 \end{matrix}$	57	43		4.7	22	ϕ_0 = 38 58 32
Right	Z. D. $\begin{matrix} 54 & 10 & 30 \end{matrix}$	$\begin{matrix} 35 & 47 & 40 \end{matrix}$	58	48		5.6	31	
			15	0	18	7.3	53	
			2	10		9.2	85	
	Mean	$\begin{matrix} 35 & 47 & 23 \\ + & 42 & \\ \hline 35 & 48 & 5 \end{matrix}$				Mean	31.3	log cos ϕ_0 9.8906
	Refraction ..	$\begin{matrix} - & 21 & \\ \hline 35 & 48 & 5 \end{matrix}$						log cos δ 9.4192
	$\zeta_0 =$	$\begin{matrix} 35 & 48 & 5 \\ - & 21 & \\ \hline 35 & 47 & 44 \end{matrix}$				$31.3 \times 2 = 62.6$		log cosec ζ_0 0.2328
	$\zeta =$	$\begin{matrix} 35 & 47 & 44 \\ \phi = 38^\circ 58' 53'' \end{matrix}$						log A 9.5426
								log 62.6 1.7965
								log Am 1.3391

For the above formula t should be less than 20 minutes, and ζ greater than 10° .

Longitude by Lunar Zenith Distances.

The local time and the chronometer error having been determined from the star observations

Let ζ_0 = the observed zenith distance of the moon's limb.

Θ = the local sidereal time of the observation of ζ_0 .

L_1 = an assumed value of the longitude.

ΔL_1 = the required correction of L_1 .

L = the true longitude = $L_1 + \Delta L_1$.

ϕ = the latitude.

Find the Greenwich time corresponding to Θ and L_1 , for which take

δ = the moon's declination.

π = the moon's equatorial horizontal parallax.

S = the moon's geocentric semi-diameter.

} from the
'Naut. Alm.'

* The circle readings will be alternately altitudes and zenith distances \pm the index error of the instrument, which error is eliminated in the mean of a pair of observations.

Let S_1 be the moon's apparent semi-diameter, and π_1 the corrected parallax,

$$\text{then } S_1 = S + \Delta S, \text{ and } \pi_1 = \pi + \Delta \pi;$$

and the values of ΔS and $\Delta \pi$ may be interpolated from the tables below, which are abridged from Chauvenet.

Also put $\delta_1 = \delta + e^2 \pi_1 \sin \phi \cos \delta$, in which $\log e^2 = 7.8244$; and let r be the refraction for the apparent zen. dis. ζ_0 ;

$$\begin{aligned} \text{and let } \zeta_2 &= \zeta_0 + r \pm S_1, \\ \text{and } \zeta_1 &= \zeta_2 - \pi_1 \sin \zeta_2; \end{aligned}$$

then the hour angle, t , is found from the equation

$$\sin^2 \frac{1}{2} t = \frac{\sin \frac{1}{2} [\zeta_1 + (\phi - \delta_1)] \sin \frac{1}{2} [\zeta_1 - (\phi - \delta_1)]}{\cos \phi \cos \delta_1},$$

after which the moon's right ascension, \mathcal{R} , is found by the formula

$$\mathcal{R} = \Theta - t.$$

Values of ΔS , always +.							Value of $\Delta \pi$, always +.			
Apparent Zen. Dis. of Moon.	Horizontal Semi-diameter.						Latitude.	Equatorial Parallax.		
	' 14 30	' 15 0	' 15 30	' 16 0	' 16 30	' 17 0		' 53	' 57	' 61
0	"	"	"	"	"	"	0	"	"	"
0	13.7	14.6	15.6	16.7	17.7	18.8	0	0.0	0.0	0.0
10	13.5	14.4	15.4	16.4	17.5	18.6	10	0.3	0.3	0.4
20	12.9	13.8	14.7	15.7	16.7	17.7	20	1.2	1.3	1.4
30	11.8	12.7	13.5	14.4	15.4	16.3	30	2.7	2.9	3.1
40	10.5	11.2	12.0	12.8	13.6	14.4	40	4.4	4.7	5.1
50	8.8	9.4	10.1	10.7	11.4	12.1	50	6.2	6.7	7.2
60	6.9	7.3	7.9	8.4	8.9	9.5	60	8.0	8.6	9.2
70	4.7	5.1	5.4	5.8	6.1	6.5	70	9.4	10.1	10.8
80	2.4	2.6	2.8	3.0	3.2	3.4	80	10.3	11.1	11.9
90	0.1	0.1	0.1	0.1	0.2	0.2	90	10.6	11.4	12.2

The Greenwich mean time corresponding to the moon's \mathcal{R} must be found from the 'Nautical Almanac'; with this and the local mean time a value of the longitude is determined, which, however, is approximate only, as t ,

is computed with an approximate value of δ depending on the assumed longitude. Put L_2 for the approximate value of the longitude which is thus determined, and

put $\beta =$ the increase of δ in a unit of time $\left\{ \begin{array}{l} \text{at the Greenwich mean} \\ \text{time of the observation of} \\ \text{the moon;} \end{array} \right.$
 and $\lambda =$ " " \mathcal{R} " "

$$\text{also let } a = \frac{\beta}{15\lambda} \left\{ \frac{\tan \phi}{\sin t} - \frac{\tan \delta}{\tan t} \right\};$$

$$\text{then } \Delta L_1 = \frac{L_2 - L_1}{1 + a}, \text{ and } L = L_1 + \Delta L_1.$$

These formulæ are demonstrated in Chauvenet, vol. i. pages 383 to 385; and when several observations have to be reduced, they entail less labour of computation than any other formula.

Example.—In latitude $\phi = 38^\circ 58' 53''$ and assumed longitude $L_1 = 5$ h. 6 m. west of Greenwich, on May 2nd, 1849, the moon being east of the meridian, the zenith distance of the moon's upper limb was observed to be $57^\circ 47' 28\cdot5''$, when the local mean time was 5 h. 33 m. 21·6 s., and the local sidereal time $\Theta = 8$ h. 16 m. 14·61 s.

Approximate Greenwich mean time,

10 h. 39 m. 21·6 s.

for which we find from the

'N. A.' $\delta = +3^\circ 47' 47\cdot6''$

$S = 15 \quad 16\cdot4$

$\pi = 56 \quad 3\cdot1$

Bar. 30·45 in.)	$\zeta_0 =$	57	47	28·5
Att. Therm. 63° F.)	$r =$	+	1	30·9
Ext. „ 65° F.)	$S_1 =$	+	15	24·5

$\zeta_2 = 58 \quad 4 \quad 23\cdot9$

$-\pi_1 \sin \zeta_2 = - \quad 47 \quad 38\cdot1$

and from the tables on page we find

$\Delta S = \quad + \quad 8\cdot1$

$\Delta \pi = \quad + \quad 4\cdot4$

$e^2 \pi_1 \sin \phi \left. \begin{array}{l} \right\} = \quad + \quad 14\cdot1 \\ \cos \delta \end{array} \right.$

$\zeta_1 = 57 \quad 16 \quad 45\cdot8$

$\delta_1 = \underline{\underline{3 \quad 48 \quad 1\cdot7}}$

With these values of δ_1 , ζ_1 , and ϕ we find—

H. M. S.
 $t = -3 \quad 19 \quad 53\cdot64;$

but $\Theta = 8 \quad 16 \quad 14\cdot61;$

whence the computed $\mathcal{R} = 11 \quad 36 \quad 8\cdot25.$

The corresponding Greenwich mean time for this value	}	H.	M.	S.	
of the \mathcal{R} is		10	39	48	7
The local mean time is		5	33	21	6
Whence the approx. long. L_2 is		5	6	27	1

For the Greenwich mean time $10^{\text{h}} 39^{\text{m}} 48.7^{\text{s}}$ { increase of \mathcal{R} in 1 = $2.014 = \lambda$.
 ,, δ ,, = $10.01 = \beta$.

Whence $a = -0.3317$; and since $L_2 - L_1 = +27.1$ s.,

$$\Delta L_1 = 40.6, \text{ and } L = 5^{\text{h}} 6^{\text{m}} 40.6^{\text{s}}.$$

Formulae for the reduction of Azimuth Observations.

(1.) When a star is observed at an elongation.

Let A be the azimuth, δ the declination, ϕ the latitude.

$$\text{Then } \sin A = \frac{\cos \delta}{\cos \phi}.$$

(2.) When a star is observed at a short distance from the elongation.

Let t be the hour angle at the time of elongation,

$$\text{then } \cos t = \frac{\tan \phi}{\tan \delta}.$$

Let dt be the difference between the hour angles at the times of elongation and of observation, and dA the corresponding difference of azimuth,

$$\text{then } \tan dA = -2 \sin^2 \frac{dt}{2} \sec \phi \cot \delta \operatorname{cosec} t;$$

whence if dt is expressed in *minutes of time*, and κ is a constant,

$$\log \kappa \text{ being } = .29303 + \log \sec \phi + \log \cot \delta + \log \operatorname{cosec} t,$$

$$dA'' = -\kappa (dt)^2.$$

(3.) When two stars are observed at their elongations.

Let their azimuths be A_1 and A_2 , and their declinations δ_1 and δ_2 ,

$$\text{then } \sin A_1 = \frac{\cos \delta_1}{\cos \delta_2} \sin A_2.$$

The value of $A_1 + A_2$ or of $A_1 - A_2$ is given by the observations, $A_1 + A_2$ if the stars are at opposite elongations, $A_1 + A_2$ if they are at the same elongation. Suppose that we have

$$A_1 \pm A_2 = m,$$

$$\text{then } \cot A_1 = \cot m \pm \frac{\cos \delta_2}{\cos \delta_1} \operatorname{cosec} m,$$

$$\text{or } \cot A_2 = \cot m \pm \frac{\cos \delta_1}{\cos \delta_2} \operatorname{cosec} m.$$

21. ADJUSTMENT OF THE "EVEREST THEODOLITE."

(Furnished by CAPTAIN PRATT, R.E.)

It is stated that this theodolite is likely to be adopted into the service of the Royal Engineers. It is therefore thought advisable to describe its adjustments.

1. *Correction for Parallax.*—Adjust the eye-piece to distinct vision of cross hairs, and correct for parallax by means of the object-glass screw.

2. *Making the Level of the Horizontal Limb parallel to that Limb.*—Clamp the tribrach * to axis, and unclamp the horizontal vernier-plate. Move the latter so that the horizontal limb's level may be over, or parallel to, two foot-screws. By means of these screws bring the bubble to the centre of level. Turn the vernier-plate round 180° , and correct the level's error half by the foot-screws and half by the level's capstan-headed screws. Turn the vernier-plate back to its original position; and if the bubble is not now exactly in the centre, correct as before. Repeat the process till accuracy is obtained.

3. *Levelling the Instrument, i.e., making its vertical axis truly vertical.*—Clamp the tribrach to axis, and unclamp the horizontal vernier-plate. Level the horizontal limb's level by the foot-screws. Turn the horizontal vernier-plate round 90° and re-level. This will make the vertical axis approximately vertical. Then bring the bubble of the vertical limb's level to the centre of bulb by the two antagonising screws at bottom of

* Modern instruments are set on a tribrach, or 3-armed support, at the top of the stand, instead of being screwed on to the top of it. This is a great improvement in many ways.

vertical vernier-plate. Turn round 180° ; and if the vertical limb's level is disturbed, correct half of the error by the foot-screws and half by the two antagonistic screws. Turn the horizontal plate 90° , and repeat the process till accuracy is obtained.

If the bubble of the level attached to the horizontal plate is now disturbed, bring it to centre of bulb by the capstan-headed screw, so as to make it an index of horizontality.

4. Collimation.

(a) *Vertical Collimation*.—Unclamp the vertical limb, and make its level horizontal by means of the antagonising screws. By means of the vertical limb's tangent-screw get the horizontal spider-line to cover some well-defined distant point. Read off the angle on the vertical verniers.

Reverse the instrument on its bearings, re-level, and re-intersect the same object. If now the vertical verniers read as at first, the vertical collimation is correct. If not, the mean of the readings is the true angular deviation from the horizontal. By means of the vertical limb's tangent-screw make the vertical verniers read this true deviation, and intersect the distant point by means of the antagonising screws.

This will disturb the level of the vertical limb. Restore its horizontality by means of the capstan-headed adjusting screws. The verniers should now read the same angle in both positions of the transit axis. If not, repeat the process till accuracy is obtained.

(b) *Horizontal Collimation*.—Intersect some well-defined distant point with the spider-lines. Reverse the instrument on its bearings. If there is any deviation from the intersection, correct half with the tangent-screw of the horizontal limb and half with the capstan-headed screws which move the diaphragm. Reverse the instrument on its bearings, and repeat similar corrections till accuracy is obtained.

22. TABLES.

Explanation of the Tables.

Table I. contains the sun's declination, to the nearest minute, for the years 1883-84-85 and '86; the declinations for the years 1887-88-89, and '90 are almost equally correct.

Table II. contains the equation of time for 1883-84-85 and '86 to the nearest second, and will serve very well for common purposes for the 4th or 8th years after. The error will be greatest from the latter end

of May to the middle of July, to 2" or 3" in a period of four years. The words "add" or "sub" indicate the manner in which the equation is to be applied to *apparent time* to convert it into mean time.

Table III. contains the sun's mean right ascension. The months are given at the top of the table, the days in the side column. It will be found useful for ascertaining the approximate time of an object's meridian passage, but where accuracy is necessary recourse must be had to the 'Nautical Almanac.'

To find the approximate time of a star passing the meridian, subtract the sun's right ascension from the star's right ascension (increasing the star's right ascension by 24 hours if it is less than the sun's right ascension), and the remainder will be the approximate time of the star passing the meridian.

Table IV. contains the mean places of 44 stars of the first and second magnitudes for the 1st of January, 1882, with their annual variation in right ascension and declination.

Tables V. and VI.—Table V. contains the approximate times of the meridian passages of 44 of the principal stars for the 1st of the month. To find the time of passage on any other day, *subtract* the portion of time corresponding to the day of the month in Table VI. from the time in Table V. As the times given in these tables are *apparent*, they must be converted into *mean* time by applying the equation of time as directed in Table II. should the mean time of meridian passage be required. The result arrived at by the use of these tables is only approximate, but will seldom be as much as 2 m. in error.

N.B. The altitude of any star when passing the meridian may be found by adding together the complement of the latitude of the place of observation and the declination of the star, when they are of the same name, or taking their difference when of contrary names; the altitude to be reckoned from the south point of the horizon when the latitude is north, and the contrary when south; but when the sum exceeds 90° it is to be taken from 180°, and the altitude is to be reckoned from the north in north latitude, and the south in south latitude. When using the artificial horizon, the altitude to which the index of the sextant is to be set must, of course, be *double the altitude* found by this method.

Table VII. contains the refraction for the barometer at 30 inches and Fahrenheit's thermometer at 50°. The two small tables at the side

contain corrections when the barometer differs from 30. inches or the thermometer from 50°.

Table VIII. exhibits half the time that a celestial body continues above the horizon when the latitude and declination are the same name; or below it when they are contrary names, and affords the means for computing the rising and setting of the sun, moon and stars, and the length of the night or day.

To find the time of the Sun's Rising or Setting, enter Table VIII. with the latitude and declination, and the tabular value will show the apparent time of the sun's setting when the latitude and declination are the same name, or of its rising when the latitude and declination are of contrary names, and this, subtracted from 12 hours, will give the apparent time of the sun's rising in the former case, and of its setting in the latter.

Double the time of rising will give the length of the night.

Double the time of setting will give the length of the day.

(*Example.*) Required the (apparent) time of the sun's rising and setting, and the length of the day and night in lat. 46° N., and the declination 18 N.

Tabular value answering to lat. 46° and decl. 18° is 7 h. 19 m. Hence in lat. N. 46°, decl. N. 18, time of sunset is 7 h. 19 m., and that of sunrise is 12 h. — 7 h. 19 m. = 4 h. 41 m.

The same is true for lat. S. 46°, decl. S. 18°.

Conversely, both for lat. N. 46°, decl. S. 18°, and for lat. S. 46°, decl. N. 18°, the time of sunrise is 7 h. 19 m., and that of sunset is 4 h. 41 m.

In the first pair of cases the length of the day is 2×7 h. 19 m. = 14 h. 38 m., and that of the night is 2×4 h. 41 m. = 9 h. 22 m.; and in the second pair, conversely, the length of the night is 14 h. 38 m., and that of the day 9 h. 32 m.

To find the time of a Star's Rising and Setting, subtract the sun's right ascension, Table III., from the star's right ascension, Table IV. (increasing the star's right ascension by 24 hours if it is less than the sun's right ascension), and the remainder will be the approximate time of the star's passing the meridian, then the latitude and declination found in this table will give the time the star takes in ascending from the horizon to the meridian, and descending from the meridian to the horizon, when the latitude and declination are the same names; therefore, if these hours and

minutes be subtracted from the time of its passage over the meridian, the remainder will be the apparent time of its rising; and, if added, the sum will be the time of its setting.

When the latitude and declination are of contrary names, the time found in the table will be the half of the continuance of the star under the horizon; consequently it is to be subtracted from 12 hours to give half the time of its continuance above the horizon.

(*Example.*) At what time (apparent) does the star β *Leonis* rise and set on May 30th in lat. 46° N.?

	H.	M.
Star's R. A.	11	43
Sun's R. A.	4	27
<hr/>		
Star's approximate meridian passage	7	16
Time in table answering to lat. 46° N. and star's } declination $15^{\circ} 15'$ N. }	7	4
<hr/>		
Remainder = time of star's rising	00	12
<hr/>		
Sum = time of star's setting	14	20 P.M.
<hr/>		
OR	2	20 A.M.

(*Example.*) At what time (apparent) does the star α *Ophiuchi* rise and set on May 12th, in lat. 30° S.?

	H.	M.
Star's R. A.	17	29
Sun's R. A.	3	15
<hr/>		
Star's approximate meridian passage	14	14
Time answering in table to 30° S. lat., and star's } declination $12^{\circ} 39'$ N. = 6 h. 36 m. which, sub- } tracted from 12, gives 5 h. 30 m. }	5	30
<hr/>		
Remainder = time of star's rising	8	44
<hr/>		
Sum = time of star's setting	19	44 P.M.
<hr/>		
OR	7	44 A.M.

Table IX., giving the distance of the horizon as seen over water from different heights above it, will be found very useful both in checking exaggerated estimates of the width of lakes whose opposite shores are invisible, and also as a rude means of judging the distance of objects seen across water.

Table X. gives the values of $\frac{2 \sin^2 \text{half-hour angle}}{\sin 1''}$, and is used in finding the latitude by altitudes of the sun, or of stars when they are near the meridian: the manner of using it is shown in the example (page 56).

Table XI. gives the number of geographical miles, or minutes of the equator, contained in a degree of longitude under each parallel of latitude on the supposition of the earth's spheroidal shape with a compression of $\frac{1}{304}$.

Table XII. is for converting statute into geographical miles.

Table XIII. is for converting geographical into statute miles.

Table XIV. contains a comparison of Fahrenheit, Reaumur, and Centegrade thermometer scales.

Table XV. contains a comparison of English and French barometer scales to hundredths of an inch.

Table XVI. gives the natural cosines of angles from 0° to 90° . The several columns of cosines are headed by degrees, the accompanying minutes being inserted in the first column on the left of the page; this is equally a column of seconds, and is accordingly headed with the marks for minutes and seconds. The number of degrees and minutes of an arc or angle is found in the column of cosines under the degrees and in a line with the minutes found in the first column; if there are seconds also in the arc or angle, again refer to the first column for these, and in the same horizontal line with them in the column headed "parts for," next to the column from which the cosine has been extracted, will be found the correction for seconds, which is always to be *subtracted*, and the remainder will be the cosine of the given degrees, minutes, and seconds. When the angle or arc for which the cosine is required is greater than 90° , the table must be entered with its supplement and the corresponding cosine regarded as negative. The decimal points have not been inserted before each cosine; and in the computation, for which this table was specially prepared by *Professor J. R. Young*, the numbers may always be regarded as integers.

Example 1. Suppose the natural cosine of $39^{\circ} 22' 33''$ were required: Turning to the page containing 39 on the top, we find "parts" against $33''$ to be 103, and the cosine against $22'$ to be 773103; subtracting 103 from this, we get the cosine required, 773000.

2. Required the cosine for $120^{\circ} 18' 20''$: the supplement of this is $59^{\circ} 41' 40''$. Under 59° and against $40''$ we find 168 parts, and against $41'$ the cosine is 504779; subtracting the 168 from this 504611, which is negative because the proposed angle is greater than 90° . Since the sine of any angle is the cosine of its complement, the sine of an angle may be obtained from this table, by taking out the cosine of the defect from, or the excess above 90° . The sine of $50^{\circ} 37' 27''$ is, for instance, the same as the cosine of $39^{\circ} 22' 33''$: and the sine of $149^{\circ} 41' 40''$ is the same as the cosine of $59^{\circ} 41' 40''$. The tangent of an angle is its sine divided by its cosine, and may be also readily found from this table.

3. Required the angle whose cosine is 568293:

By the table	568323 = 55	22
Given cosine	568293	
								"
Parts for secs.		30 7'5

Angle required is $55^{\circ} 22' 7''.5$.

If the cosine given had been negative — 568293, the supplement of this angle, namely, $124^{\circ} 37' 52''.5$, would have been the angle to which that cosine belongs.

TABLE I.—DECLINATION OF THE SUN FOR THE YEARS 1883 AND 1887 AT MEAN NOON AT GREENWICH.

Day.	Jan.	Feb.	March.	April.	May.	June.	July.	Aug.	Sept.	Oct.	Nov.	Dec.
1	0 1 23 18.	0 1 17 78.	0 1 7 368.	0 1 4 31N.	0 1 15 3N.	0 1 22 3N.	0 1 23 8N.	0 1 18 3N.	0 1 8 19N.	0 1 3 108.	0 1 14 258.	0 1 21 498.
2	22 56	16 49	7 13	4 54	15 21	22 11	23 4	17 48	7 57	3 33	14 44	21 58
3	22 50	16 32	6 50	5 17	15 39	22 19	22 59	17 33	7 35	3 56	15 3	22 6
4	22 44	16 14	6 27	5 40	15 57	22 26	22 54	17 17	7 13	4 19	15 22	22 15
5	22 37	15 56	6 4	6 3	16 14	22 33	22 49	17 1	6 51	4 42	15 40	22 23
6	22 30	15 38	5 41	6 26	16 31	22 39	22 43	16 44	6 29	5 6	15 59	22 30
7	22 23	15 19	5 18	6 48	16 48	22 45	22 37	16 28	6 6	5 29	16 16	22 37
8	22 15	15 0	4 54	7 11	17 4	22 51	22 30	16 11	5 44	5 52	16 34	22 44
9	22 7	14 41	4 31	7 33	17 20	22 56	22 23	15 54	5 21	6 14	16 51	22 50
10	21 58	14 22	4 7	7 56	17 36	23 1	22 16	15 36	4 59	6 37	17 8	22 55
11	21 49	14 2	3 44	8 18	17 52	23 5	22 8	15 19	4 36	7 0	17 25	23 1
12	21 39	13 42	3 20	8 40	18 7	23 9	22 0	15 1	4 13	7 23	17 42	23 5
13	21 29	13 22	2 57	9 1	18 22	23 13	21 51	14 43	3 50	7 45	17 58	23 10
14	21 19	13 2	2 33	9 23	18 37	23 16	21 43	14 24	3 27	8 8	18 14	23 13
15	21 8	12 41	2 9	9 45	18 51	23 19	21 33	14 6	3 4	8 30	18 29	23 17
16	20 57	12 20	1 46	10 6	19 5	23 21	21 24	13 47	2 41	8 52	18 44	23 20
17	20 45	12 0	1 22	10 27	19 19	23 23	21 14	13 28	2 18	9 14	18 59	23 22
18	20 33	11 39	0 58	10 48	19 32	23 25	21 3	13 9	1 54	9 36	19 14	23 24
19	20 21	11 17	0 34	11 9	19 45	23 26	20 53	12 49	1 31	9 58	19 28	23 25
20	20 8	10 56	0 118.	11 30	19 58	23 27	20 42	12 29	1 8	10 19	19 42	23 26
21	19 55	10 34	0 13N.	11 50	20 10	23 27	20 30	12 10	0 44	10 41	19 55	23 27
22	19 41	10 12	0 37	12 11	20 22	23 27	20 19	11 49	0 21N.	11 2	20 8	23 27
23	19 27	9 50	1 0	12 31	20 34	23 27	20 7	11 29	0 28.	11 23	20 21	23 27
24	19 13	9 28	1 24	12 50	20 45	23 26	19 54	11 9	0 26	11 44	20 33	23 26
25	18 58	9 6	1 48	13 10	20 56	23 24	19 41	10 48	0 49	12 5	20 45	23 24
26	18 43	8 44	2 11	13 30	21 7	23 23	19 28	10 27	1 13	12 26	20 57	23 23
27	18 28	8 21	2 35	13 49	21 17	23 20	19 15	10 6	1 36	12 46	21 8	23 20
28	18 12	7 59	2 58	14 8	21 27	23 18	19 1	9 45	1 59	13 6	21 19	23 18
29	17 56	..	3 21	14 27	21 37	23 15	18 47	9 24	2 23	13 27	21 29	23 14
30	17 40	..	3 45	14 45	21 46	23 12	18 33	9 3	2 46	13 46	21 39	23 11
31	17 23	..	4 8	..	21 55	..	18 18	8 41	..	14 6	..	23 7

TABLE I. (continued).—DECLINATION OF THE SUN FOR THE YEARS 1884 AND 1888
AT MEAN NOON AT GREENWICH.

Day	Jan.	Feb.	March.	April.	May.	June.	July.	Aug.	Sept.	Oct.	Nov.	Dec.
1	0 1 23 28.	0 1 17 11.8.	0 1 7 19.8.	0 1 4 49N.	0 1 15 17N.	0 1 22 9N.	0 1 23 5N.	0 1 17 52N.	0 1 8 3N.	0 1 3 27.8.	0 1 14 40.8.	0 1 21 56.8.
2	22 57	16 53	6 56	5 12	15 35	22 17	23 0	17 37	7 41	3 50	14 59	22 4
3	22 51	16 36	6 33	5 35	15 53	22 24	22 55	17 21	7 19	4 14	15 18	22 13
4	22 45	16 18	6 10	5 58	16 10	22 31	22 50	17 5	6 57	4 37	15 36	22 21
5	22 39	16 0	5 46	6 20	16 27	22 38	22 44	16 48	6 34	5 0	15 54	22 28
6	22 32	15 42	5 23	6 43	16 44	22 44	22 38	16 32	6 12	5 23	16 12	22 35
7	22 25	15 23	5 0	7 5	17 0	22 49	22 32	16 15	5 49	5 46	16 30	22 42
8	22 17	15 5	4 36	7 28	17 16	22 55	22 25	15 58	5 27	6 9	16 47	22 48
9	22 9	14 46	4 13	7 50	17 32	23 0	22 18	15 41	5 4	6 32	17 4	22 54
10	22 0	14 26	3 49	8 12	17 48	23 4	22 10	15 23	4 41	6 54	17 21	22 59
11	21 51	14 7	3 26	8 34	18 3	23 8	22 2	15 5	4 19	7 17	17 38	23 4
12	21 42	13 47	3 2	8 56	18 18	23 12	21 54	14 47	3 56	7 40	17 54	23 9
13	21 32	13 27	2 39	9 18	18 33	23 15	21 45	14 29	3 33	8 2	18 10	23 11
14	21 21	13 7	2 15	9 39	18 48	23 18	21 36	14 10	3 10	8 24	18 25	23 16
15	21 11	12 46	1 51	10 1	19 2	23 21	21 26	13 52	2 46	8 47	18 41	23 19
16	21 0	12 26	1 28	10 22	19 15	23 23	21 16	13 33	2 23	9 9	18 56	23 21
17	20 48	12 5	1 4	10 43	19 29	23 25	21 6	13 13	2 0	9 31	19 10	23 24
18	20 36	11 44	0 40	11 4	19 42	23 26	20 55	12 54	1 37	9 52	19 24	23 25
19	20 24	11 22	0 17.8.	11 25	19 55	23 27	20 45	12 34	1 13	10 14	19 38	23 26
20	20 11	11 1	0 7N.	11 45	20 7	23 27	20 33	12 14	0 50	10 36	19 52	23 27
21	19 58	10 39	0 31	12 6	20 19	23 27	20 22	11 54	0 27	10 57	20 5	23 27
22	19 44	10 18	0 55	12 26	20 31	23 27	20 10	11 34	0 3N.	11 18	20 18	23 27
23	19 31	9 56	1 18	12 46	20 43	23 26	19 57	11 14	0 20.8.	11 39	20 30	23 26
24	19 16	9 34	1 42	13 5	20 54	23 25	19 45	10 53	0 44	12 0	20 42	23 25
25	19 2	9 12	2 5	13 25	21 4	23 23	19 32	10 32	1 7	12 21	20 54	23 23
26	18 47	8 49	2 29	13 44	21 15	23 21	19 18	10 12	1 30	12 41	21 5	23 21
27	18 32	8 27	2 52	14 3	21 25	23 18	19 5	9 50	1 54	13 2	21 16	23 18
28	18 16	8 4	3 16	14 22	21 34	23 16	18 51	9 29	2 17	13 22	21 27	23 15
29	18 0	7 41	3 39	14 41	21 44	23 12	18 37	9 8	2 41	13 42	21 37	23 12
30	17 44	..	4 2	14 59	21 52	23 9	18 22	8 46	3 4	14 1	21 46	23 8
31	17 27	..	4 26	..	22 1	..	18 7	8 25	..	14 21	..	23 3

TABLE I. (continued).—DECLINATION OF THE SUN FOR THE YEARS 1885 AND 1889
AT MEAN NOON AT GREENWICH.

Day.	Jan.	Feb.	March.	April.	May.	June.	July.	Aug.	Sept.	Oct.	Nov.	Dec.
1	0 1 22 58 s.	0 1 16 58 s.	0 1 7 24 s.	0 1 4 43 N.	0 1 15 13 N.	0 1 22 7 N.	0 1 23 6 N.	0 1 17 56 N.	0 1 8 8 N.	0 1 3 21 s.	0 1 14 35 s.	0 1 21 53 s.
2	22 53	16 40	7 1	5 6	15 31	22 15	23 1	17 40	7 46	3 45	14 54	22 2
3	22 47	16 23	6 38	5 29	15 48	22 22	22 56	17 25	7 24	4 8	15 13	22 11
4	22 41	16 5	6 15	5 52	16 6	22 29	22 51	17 9	7 2	4 31	15 31	22 19
5	22 34	15 46	5 52	6 15	16 23	22 36	22 46	16 53	6 40	4 54	15 50	22 26
6	22 27	15 28	5 29	6 37	16 40	22 42	22 40	16 36	6 18	5 17	16 8	22 34
7	22 19	15 9	5 6	7 0	16 56	22 48	22 33	16 19	5 55	5 40	16 25	22 40
8	22 11	14 50	4 41	7 22	17 12	22 53	22 27	16 2	5 32	6 3	16 43	22 47
9	22 2	14 31	4 19	7 45	17 28	22 58	22 19	15 45	5 10	6 26	17 0	22 53
10	21 53	14 11	3 55	8 7	17 44	23 3	22 12	15 27	4 47	6 49	17 17	22 58
11	21 44	13 52	3 32	8 29	18 0	23 7	22 4	15 10	4 24	7 11	17 34	23 3
12	21 34	13 32	3 8	8 51	18 15	23 11	21 56	14 52	4 1	7 34	17 50	23 7
13	21 24	13 12	2 44	9 13	18 29	23 15	21 47	14 33	3 38	7 56	18 6	23 12
14	21 13	12 51	2 21	9 34	18 44	23 18	21 38	14 15	3 15	8 19	18 22	23 15
15	21 2	12 31	1 57	9 56	18 58	23 20	21 28	13 56	2 52	8 41	18 37	23 18
16	20 51	12 10	1 33	10 17	19 12	23 22	21 19	13 37	2 29	9 3	18 52	23 21
17	20 39	11 49	1 10	10 38	19 26	23 24	21 9	13 18	2 6	9 25	19 7	23 23
18	20 27	11 28	0 46	10 59	19 39	23 25	20 58	12 59	1 42	9 47	19 21	23 25
19	20 14	11 6	0 22 s.	11 20	19 52	23 26	20 47	12 39	1 19	10 9	19 35	23 26
20	20 1	10 45	0 2 N.	11 40	20 4	23 27	20 36	12 19	0 56	10 30	19 49	23 27
21	19 48	10 23	0 25	12 1	20 17	23 27	20 24	11 59	0 33	10 52	20 2	23 27
22	19 34	10 1	0 49	12 21	20 28	23 27	20 13	11 39	0 9 N.	11 13	20 15	23 27
23	19 20	9 39	1 12	12 41	20 40	23 26	20 0	11 19	0 14 s.	11 34	20 27	23 26
24	19 5	9 17	1 36	13 1	20 51	23 25	19 48	10 58	0 38	11 55	20 39	23 25
25	18 50	8 55	2 0	13 20	21 2	23 23	19 35	10 38	1 1	12 16	20 51	23 24
26	18 35	8 32	2 23	13 39	21 12	23 21	19 22	10 17	1 25	12 36	21 2	23 22
27	18 20	8 10	2 47	13 59	21 22	23 19	19 8	9 56	1 48	12 56	21 13	23 19
28	18 4	7 47	3 10	14 17	21 32	23 16	18 54	9 34	2 11	13 17	21 24	23 16
29	17 48	..	3 33	14 36	21 41	23 13	18 40	9 13	2 35	13 37	21 34	23 13
30	17 31	..	3 57	14 54	21 50	23 10	18 26	8 52	2 58	13 56	21 44	23 9
31	17 15	..	4 20	..	21 59	..	18 11	8 30	..	14 16	..	23 4

TABLE I. (continued).—DECLINATION OF THE SUN FOR THE YEARS 1886 AND 1900
AT MEAN NOON AT GREENWICH.

Day.	Jan.	Feb.	March.	April.	May.	June.	July.	Aug.	Sept.	Oct.	Nov.	Dec.
1	0 1 22 59.8.	0 1 17 28.	0 1 7 30.8.	0 1 4 37N.	0 1 15 8N.	0 1 22 5N.	0 1 23 7N.	0 1 17 59N.	0 1 8 13N.	0 1 3 16.8.	0 1 14 31.8.	0 1 21 51.8.
2	22 54	16 45	7 7	5 0	15 26	22 13	23 2	17 44	7 52	3 39	14 50	22 0
3	22 48	16 27	6 44	5 23	15 44	22 20	22 58	17 28	7 30	4 2	15 8	22 9
4	22 42	16 9	6 21	5 46	16 1	22 28	22 53	17 13	7 7	4 26	15 27	22 17
5	22 35	15 51	5 58	6 9	16 19	22 34	22 47	16 56	6 45	4 49	15 45	22 25
6	22 28	15 33	5 35	6 32	16 35	22 41	22 41	16 40	6 23	5 12	16 3	22 32
7	22 21	15 14	5 11	6 54	16 52	22 47	22 35	16 23	6 0	5 35	16 21	22 39
8	22 13	14 55	4 48	7 17	17 9	22 52	22 28	16 6	5 38	5 58	16 39	22 45
9	22 4	14 36	4 24	7 39	17 25	22 57	22 21	15 49	5 15	6 21	16 56	22 51
10	21 56	14 16	4 1	8 1	17 40	23 2	22 14	15 32	4 52	6 43	17 13	22 57
11	21 46	13 57	3 37	8 24	17 56	23 6	22 6	15 14	4 30	7 6	17 30	23 2
12	21 37	13 37	3 14	8 45	18 11	23 10	21 58	14 56	4 7	7 29	17 46	23 6
13	21 26	13 17	2 50	9 7	18 26	23 14	21 49	14 38	3 44	7 51	18 1	23 11
14	21 16	12 56	2 27	9 29	18 41	23 17	21 40	14 19	3 21	8 14	18 18	23 14
15	21 5	12 36	2 3	9 50	18 55	23 20	21 31	14 1	2 58	8 36	18 33	23 17
16	20 54	12 15	1 39	10 12	19 9	23 22	21 21	13 42	2 34	8 58	18 48	23 20
17	20 42	11 54	1 15	10 33	19 22	23 24	21 11	13 23	2 11	9 20	19 3	23 23
18	20 30	11 33	0 52	10 54	19 36	23 25	21 1	13 3	1 48	9 42	19 17	23 24
19	20 17	11 12	0 28	11 15	19 49	23 26	20 50	12 44	1 25	10 4	19 31	23 26
20	20 4	10 50	0 4.8.	11 35	20 1	23 27	20 39	12 24	1 1	10 25	19 45	23 27
21	19 51	10 28	0 19N.	11 56	20 14	23 27	20 27	12 4	0 38	10 47	19 59	23 27
22	19 37	10 7	0 43	12 16	20 25	23 27	20 15	11 44	0 15N.	11 8	20 12	23 27
23	19 23	9 45	1 7	12 36	20 37	23 26	20 3	11 24	0 9.8.	11 29	20 24	23 26
24	19 9	9 22	1 30	12 56	20 48	23 25	19 51	11 3	0 32	11 50	20 36	23 25
25	18 54	9 0	1 54	13 15	20 59	23 24	19 38	10 43	0 56	12 11	20 48	23 24
26	18 39	8 38	2 17	13 35	21 10	23 22	19 25	10 22	1 19	12 31	21 0	23 22
27	18 24	8 15	2 41	13 54	21 20	23 20	19 11	10 1	1 42	12 52	21 11	23 20
28	18 8	7 53	3 4	14 13	21 30	23 17	18 58	9 40	2 6	13 12	21 22	23 17
29	17 52	..	3 28	14 32	21 39	23 14	18 43	9 18	2 29	13 32	21 32	23 13
30	17 36	..	3 51	14 50	21 48	23 10	18 29	8 57	2 53	13 52	21 42	23 10
31	17 19	..	4 14	..	21 57	..	18 14	8 35	..	14 11	..	23 5

TABLES.

TABLE II.—EQUATION OF TIME FOR THE YEAR 1883, FOR APPARENT
AT GREENWICH.

Day.	Jan.	Feb.	March.	April.	May.	June.	July.	Aug.	Sept.	Oct.	Nov.
	Add m. s.	Add m. s.	Add m. s.	Add m. s.	Sub. m. s.	Sub. m. s.	Add m. s.	Add m. s.	Sub. m. s.	Sub. m. s.	Sub. m. s.
1	3 45	13 49	12 33	3 59	3 0	2 29	3 30	6 6	0 3	10 16	16 18
2	4 13	13 56	12 21	3 41	3 8	2 20	3 41	6 3	0 22	10 35	16 19
3	4 41	14 3	12 9	3 23	3 14	2 10	3 53	5 58	0 41	10 54	16 19
4	5 9	14 9	11 56	3 5	3 20	2 0	4 4	5 53	1 0	11 12	16 19
5	5 36	14 14	11 42	2 47	3 26	1 50	4 15	5 48	1 20	11 30	16 17
6	6 3	14 18	11 28	2 30	3 31	1 39	4 25	5 42	1 40	11 48	16 15
7	6 29	14 22	11 14	2 13	3 36	1 28	4 35	5 35	2 0	12 5	16 12
8	6 55	14 25	10 59	1 56	3 39	1 17	4 45	5 28	2 20	12 22	16 8
9	7 20	14 27	10 44	1 39	3 43	1 5	4 54	5 20	2 41	12 38	16 3
10	7 44	14 28	10 29	1 23	3 45	0 54	5 3	5 12	3 1	12 54	15 58
11	8 9	14 28	10 13	1 6	3 48	0 42	5 11	5 3	3 22	13 10	15 52
12	8 32	14 28	9 57	0 50	3 49	0 30	5 19	4 53	3 43	13 25	15 44
13	8 55	14 27	9 41	0 35	3 50	0 17	5 27	4 43	4 4	13 40	15 36
14	9 17	14 25	9 24	0 19	3 51	0 5	5 34	4 32	4 25	13 54	15 28
15	9 39	14 22	9 7	0 4 Sub.	3 51	0 8	5 40	4 21	4 46	14 7	15 18
16	9 59	14 19	8 50	0 10	3 50	0 20	5 46	4 9	5 8	14 20	15 7
17	10 20	14 14	8 33	0 25	3 49	0 33	5 51	3 56	5 29	14 33	14 56
18	10 39	14 10	8 15	0 39	3 47	0 46	5 56	3 43	5 50	14 45	14 44
19	10 58	14 4	7 57	0 52	3 45	0 59	6 1	3 30	6 11	14 56	14 31
20	11 15	13 58	7 39	1 6	3 43	1 12	6 4	3 16	6 33	15 7	14 17
21	11 33	13 51	7 21	1 18	3 39	1 25	6 8	3 2	6 54	15 16	14 2
22	11 49	13 43	7 3	1 31	3 35	1 38	6 10	2 47	7 15	15 26	13 46
23	12 4	13 35	6 44	1 43	3 31	1 51	6 13	2 32	7 36	15 34	13 30
24	12 19	13 26	6 26	1 54	3 26	2 3	6 14	2 16	7 56	15 42	13 13
25	12 33	13 17	6 7	2 5	3 21	2 16	6 51	2 0	8 17	15 49	12 55
26	12 46	13 7	5 49	2 16	3 15	2 29	6 16	1 43	8 37	15 56	12 36
27	12 59	12 56	5 30	2 26	3 8	2 41	6 15	1 27	8 58	16 1	12 17
28	13 10	12 45	5 12	2 35	3 1	2 54	6 15	1 9	9 18	16 6	11 56
29	13 21	..	4 53	2 44	2 54	3 6	6 14	0 52	9 37	16 10	11 35
30	13 31	...	4 35	2 52	2 46	3 18	6 12	0 34	9 57	16 14	11 14
31	13 40	..	4 17	..	2 38	..	6 9	0 16	..	16 16	..

TABLE II. (continued).—EQUATION OF TIME FOR THE YEAR 1884,
FOR APPARENT NOON AT GREENWICH.

Day.	Jan.	Feb.	March.	April.	May.	June.	July.	Aug.	Sept.	Oct.	Nov.	Dec.
	Add m. s.	Add m. s.	Add m. s.	Add m. s.	Sub. m. s.	Sub. m. s.	Add m. s.	Add m. s.	Sub. m. s.	Sub. m. s.	Sub. m. s.	Sub. m. s.
1	3 38	13 47	12 25	3 46	3 5	2 22	3 39	6 3	0 17	10 30	16 19	10 34
2	4 7	13 55	12 12	3 28	3 12	2 12	3 50	5 59	0 37	10 49	16 19	10 10
3	4 35	14 2	12 0	3 10	3 18	2 3	4 1	5 54	0 56	11 8	16 19	9 46
4	5 2	14 8	11 46	2 52	3 24	1 53	4 11	5 48	1 16	11 26	16 18	9 22
5	5 29	14 13	11 32	2 35	3 30	1 42	4 22	5 42	1 36	11 44	16 16	8 57
6	5 56	14 18	11 18	2 17	3 34	1 32	4 32	5 36	1 56	12 1	16 13	8 32
7	6 22	14 21	11 3	2 0	3 39	1 21	4 41	5 28	2 16	12 18	16 9	8 6
8	6 48	14 24	10 48	1 43	3 42	1 9	4 50	5 21	2 37	12 35	16 5	7 39
9	7 13	14 26	10 33	1 26	3 45	0 58	4 59	5 12	2 57	12 51	16 0	7 12
10	7 38	14 27	10 17	1 10	3 48	0 46	5 8	5 3	3 18	13 7	15 53	6 45
11	8 2	14 28	10 1	0 54	3 50	0 34	5 16	4 54	3 39	13 22	15 46	6 17
12	8 25	14 27	9 44	0 38	3 51	0 22	5 23	4 44	4 0	13 37	15 38	5 48
13	8 48	14 26	9 28	0 22	3 52	0 9	5 30	4 33	4 21	13 51	15 30	5 20
14	9 11	14 24	9 11	0 7	3 52	0 3	5 37	4 22	4 42	14 4	15 20	4 51
15	9 32	14 22	8 53	0 8	3 52	0 16	5 43	4 10	5 3	14 17	15 9	4 22
16	9 53	14 18	8 36	0 22	3 51	0 29	5 48	3 58	5 24	14 30	14 58	3 52
17	10 13	14 14	8 18	0 36	3 49	0 42	5 54	3 45	5 45	14 42	14 46	3 23
18	10 33	14 10	8 1	0 50	3 47	0 55	5 58	3 32	6 7	14 53	14 33	2 53
19	10 52	14 4	7 43	1 3	3 44	1 8	6 2	3 19	6 28	15 3	14 19	2 23
20	11 10	13 58	7 25	1 16	3 41	1 21	6 6	3 5	6 49	15 13	14 4	1 53
21	11 27	13 52	7 7	1 28	3 37	1 34	6 9	2 50	7 10	15 23	13 49	1 23
22	11 44	13 44	6 48	1 40	3 33	1 47	6 11	2 35	7 30	15 31	13 33	0 53
23	12 0	13 37	6 30	1 52	3 28	2 0	6 13	2 20	7 51	15 39	13 15	0 23
24	12 15	13 28	6 12	2 3	3 22	2 13	6 15	2 4	8 12	15 47	12 58	0 7
25	12 29	13 19	5 53	2 13	3 16	2 26	6 15	1 47	8 32	15 53	12 39	0 37
26	12 43	13 9	5 35	2 23	3 10	2 38	6 15	1 31	8 52	15 59	12 20	1 7
27	12 56	12 59	5 17	2 32	3 3	2 51	6 15	1 14	9 12	16 4	12 0	1 36
28	13 8	12 48	4 58	2 41	2 55	3 3	6 14	0 56	9 32	16 8	11 39	2 5
29	13 19	12 37	4 40	2 50	2 48	3 15	6 12	0 38	9 52	16 12	11 18	2 35
30	13 29	..	4 22	2 58	2 39	3 27	6 10	0 20	10 11	16 15	10 56	3 3
31	13 38	..	4 4	..	2 31	..	6 7	0 1	..	16 17	..	3 32

TABLE II. (continued).—EQUATION OF TIME FOR THE YEAR 1885,
FOR APPARENT NOON AT GREENWICH.

Day.	Jan.	Feb.	March.	April.	May.	June.	July.	Aug.	Sept.	Oct.	Nov.	Dec.
	Add	Add	Add	Add	Sub.	Sub.	Add	Add	Sub.	Sub.	Sub.	Sub
	m. s.	m. s.	m. s.	m. s.	m. s.	m. s.	m. s.	m. s.	m. s.	m. s.	m. s.	m. s.
1	4 0	13 53	12 28	3 50	3 4	2 25	3 34	6 2	0 14	10 27	16 19	10 40
2	4 28	14 0	12 15	3 32	3 11	2 16	3 45	5 58	0 33	10 46	16 20	10 17
3	4 56	14 6	12 2	3 14	3 18	2 7	3 56	5 54	0 52	11 4	16 20	9 53
4	5 23	14 12	11 49	2 56	3 24	1 57	4 7	5 48	1 12	11 22	16 18	9 28
5	5 50	13 16	11 35	2 38	3 29	1 46	4 18	5 42	1 32	11 40	16 17	9 3
6	6 16	14 20	11 21	2 21	3 34	1 36	4 28	5 36	1 52	11 58	16 14	8 38
7	6 42	14 23	11 7	2 4	3 39	1 25	4 38	5 29	2 12	12 15	16 10	8 12
8	7 7	14 26	10 52	1 47	3 42	1 13	4 47	5 22	2 32	12 31	16 6	7 45
9	7 32	14 27	10 36	1 30	3 45	1 2	4 56	5 14	2 53	12 47	16 1	7 18
10	7 56	14 28	10 21	1 14	3 48	0 50	5 5	5 5	3 13	13 3	15 55	6 51
11	8 20	14 28	10 5	0 57	3 50	0 38	5 13	4 56	3 34	13 18	15 48	6 23
12	8 43	14 27	9 48	0 42	3 51	0 25	5 21	4 46	3 55	13 33	15 40	5 55
13	9 6	14 26	9 32	0 26	3 52	0 13	5 28	4 35	4 16	13 47	15 31	5 26
14	9 28	14 23	9 15	0 11	3 52	0 0	5 35	4 25	4 37	14 1	15 22	4 57
15	9 49	14 20	8 58	0 4	3 52	0 13	5 41	4 13	4 58	14 14	15 12	4 28
16	10 10	14 17	8 41	0 18	3 51	0 26	5 47	4 1	5 19	14 27	15 1	3 59
17	10 29	14 12	8 23	0 32	3 49	0 39	5 52	3 48	5 40	14 39	14 49	3 30
18	10 49	14 7	8 6	0 46	3 47	0 52	5 57	3 35	6 1	14 50	14 36	3 0
19	11 7	14 1	7 48	0 59	3 44	1 5	6 1	3 22	6 23	15 1	14 22	2 31
20	11 25	13 55	7 30	1 12	3 41	1 18	6 5	3 8	6 44	15 11	14 8	2 1
21	11 41	13 47	7 12	1 25	3 38	1 30	6 8	2 53	7 5	15 21	13 53	1 31
22	11 58	13 40	6 54	1 37	3 34	1 43	6 10	2 38	7 26	15 30	13 37	1 1
23	12 13	13 31	6 36	1 48	3 29	1 56	6 12	2 23	7 47	15 38	13 20	0 31
24	12 27	13 22	6 17	2 0	3 24	2 9	6 14	2 7	8 7	15 46	13 3	0 1
25	12 41	13 12	5 59	2 10	3 18	2 22	6 14	1 50	8 28	15 52	12 45	0 28
26	12 54	13 2	5 40	2 21	3 12	2 34	6 14	1 34	8 48	15 59	12 26	0 58
27	13 6	12 51	5 22	2 30	3 5	2 47	6 14	1 17	9 9	16 4	12 6	1 28
28	13 17	12 40	5 3	2 40	2 58	2 59	6 13	0 59	9 29	16 9	11 45	1 57
29	13 27	..	4 45	2 48	2 51	3 11	6 11	0 41	9 48	16 12	11 24	2 26
30	13 37	..	4 26	2 57	2 43	3 22	6 9	0 23	10 8	16 15	11 2	2 55
31	13 45	..	4 8	..	2 34	..	6 6	0 5	..	16 18	..	3 24

HINTS TO TRAVELLERS.

TABLE II. (continued).—EQUATION OF TIME FOR THE YEAR 1886,
FOR APPARENT NOON AT GREENWICH.

Day.	Jan.	Feb.	March.	April.	May.	June.	July.	Aug.	Sept.	Oct.	Nov.	Dec.
	Add	Add	Add	Add	Sub.	Sub.	Add	Add	Sub.	Sub.	Sub.	Sub.
	m. s.	m. s.	m. s.	m. s.	m. s.	m. s.	m. s.	m. s.	m. s.	m. s.	m. s.	m. s.
1	3 53	13 51	12 30	3 54	3 2	2 27	3 33	6 5	0 8	10 21	16 18	10 44
2	4 21	13 58	12 18	3 36	3 10	2 18	3 44	6 1	0 27	10 40	16 18	10 21
3	4 49	14 5	12 5	3 18	3 16	2 8	3 55	5 57	0 46	10 58	16 18	9 58
4	5 16	14 10	11 52	3 0	3 22	1 58	4 6	5 52	1 5	11 17	16 18	9 33
5	5 41	14 15	11 38	2 43	3 28	1 47	4 17	5 46	1 25	11 35	16 16	9 8
6	6 10	14 20	11 24	2 25	3 32	1 37	4 27	5 40	1 45	11 52	16 14	8 43
7	6 36	14 23	11 10	2 8	3 37	1 26	4 37	5 33	2 5	12 9	16 10	8 18
8	7 2	14 25	10 55	1 51	3 41	1 14	4 47	5 25	2 26	12 26	16 6	7 51
9	7 27	14 27	10 40	1 34	3 44	1 3	4 56	5 17	2 46	12 42	16 2	7 25
10	7 51	14 28	10 25	1 18	3 46	0 51	5 4	5 9	3 7	12 58	15 56	6 57
11	8 15	14 28	10 9	1 2	3 48	0 39	5 13	4 59	3 28	13 14	15 49	6 30
12	8 38	14 27	9 53	0 46	3 50	0 27	5 20	4 49	3 49	13 29	15 42	6 2
13	9 1	14 26	9 36	0 30	3 51	0 15	5 28	4 39	4 10	13 43	15 34	5 34
14	9 23	14 24	9 19	0 15	3 51	0 2	5 34	4 28	4 31	13 57	15 25	5 5
15	9 44	14 21	9 2	0 0	3 51	0 10	5 41	4 17	4 52	14 11	15 15	4 36
16	10 5	14 17	8 45	0 15	3 51	0 23	5 46	4 5	5 14	14 24	15 4	4 7
17	10 24	14 13	8 27	0 29	3 49	0 36	5 52	3 52	5 35	14 36	14 52	3 38
18	10 44	14 7	8 10	0 43	3 48	0 49	5 57	3 39	5 56	14 47	14 40	3 8
19	11 2	14 2	7 52	0 57	3 45	1 2	6 1	3 26	6 17	14 58	14 26	2 38
20	11 20	13 55	7 34	1 10	3 42	1 14	6 4	3 12	6 38	15 9	14 12	2 9
21	11 36	13 48	7 15	1 23	3 39	1 27	6 7	2 57	6 59	15 18	13 57	1 39
22	11 53	13 40	6 57	1 35	3 35	1 40	6 10	2 42	7 20	15 27	13 41	1 9
23	12 8	13 32	6 39	1 47	3 30	1 53	6 12	2 27	7 41	15 36	13 24	0 38
24	12 23	13 23	6 20	1 58	3 25	2 6	6 14	2 11	8 2	15 43	13 7	0 8
25	12 36	13 13	6 2	2 9	3 20	2 19	6 15	1 55	8 22	15 50	12 49	0 22
26	12 49	13 3	5 43	2 19	3 14	2 32	6 15	1 39	8 43	15 56	12 30	0 51
27	13 2	12 53	5 25	2 29	3 7	2 44	6 15	1 22	9 3	16 2	12 10	1 21
28	13 13	12 41	5 7	2 38	3 0	2 56	6 14	1 5	9 23	16 7	11 50	1 51
29	13 24	..	4 48	2 47	2 52	3 9	6 13	0 47	9 42	16 10	11 28	2 20
30	13 33	..	4 30	2 55	2 44	3 21	6 11	0 29	10 2	16 14	11 7	2 49
31	13 42	..	4 11	..	2 36	..	6 8	0 11	..	16 16	..	3 18

TABLE III.—SUN'S MEAN RIGHT ASCENSION.

Days.	Jan.	Feb.	March.	April.	May.	June.	July.	Aug.	Sept.	Oct.	Nov.	Dec.
	h. m.	h. m.	h. m.	h. m.	h. m.	h. m.	h. m.	h. m.	h. m.	h. m.	h. m.	h. m.
1	18 46	20 58	22 48	0 42	2 33	4 35	6 40	8 45	10 41	12 29	14 25	16 29
2	18 50	21 02	22 52	0 45	2 37	4 40	6 44	8 49	10 44	12 32	14 29	16 33
3	18 54	21 06	22 56	0 49	2 40	4 44	6 48	8 52	10 48	12 36	14 33	16 37
4	18 59	21 10	22 59	0 53	2 44	4 48	6 52	8 56	10 52	12 40	14 37	16 42
5	19 3	21 14	23 03	0 56	2 48	4 52	6 56	9 00	10 55	12 43	14 41	16 46
6	19 8	21 18	23 07	1 00	2 52	4 56	7 00	9 04	10 59	12 47	14 45	16 51
7	19 12	21 22	23 10	1 04	2 56	5 00	7 04	9 08	11 02	12 51	14 49	16 55
8	19 16	21 26	23 14	1 07	3 00	5 04	7 09	9 12	11 06	12 54	14 53	16 59
9	19 21	21 30	23 18	1 11	3 04	5 08	7 13	9 15	11 10	12 58	14 57	17 04
10	19 25	21 34	23 21	1 15	3 08	5 13	7 17	9 19	11 13	13 02	15 01	17 08
11	19 29	21 38	23 25	1 18	3 11	5 17	7 21	9 23	11 17	13 05	15 05	17 13
12	19 34	21 42	23 29	1 22	3 15	5 21	7 25	9 27	11 20	13 09	15 09	17 17
13	19 38	21 46	23 33	1 26	3 19	5 25	7 29	9 31	11 24	13 13	15 13	17 21
14	19 42	21 50	23 36	1 29	3 23	5 29	7 33	9 34	11 28	13 16	15 17	17 26
15	19 47	21 54	23 40	1 33	3 27	5 33	7 37	9 38	11 31	13 20	15 21	17 30
16	19 51	21 58	23 43	1 37	3 31	5 37	7 41	9 42	11 35	13 24	15 25	17 35
17	19 55	22 02	23 47	1 40	3 35	5 42	7 45	9 46	11 38	13 28	15 30	17 39
18	20 00	22 05	23 51	1 44	3 39	5 46	7 49	9 49	11 42	13 31	15 34	17 43
19	20 04	22 09	23 54	1 48	3 43	5 50	7 53	9 53	11 46	13 35	15 38	17 48
20	20 08	22 13	23 58	1 51	3 47	5 54	7 57	9 57	11 49	13 39	15 42	17 52
21	20 12	22 17	0 02	1 55	3 51	5 58	8 01	10 00	11 53	13 43	15 46	17 57
22	20 17	22 21	0 05	1 59	3 55	6 02	8 05	10 04	11 56	13 46	15 50	18 01
23	20 21	22 25	0 09	2 03	3 59	6 07	8 09	10 08	12 00	13 50	15 55	18 06
24	20 25	22 28	0 13	2 06	4 03	6 11	8 13	10 12	12 04	13 54	15 59	18 10
25	20 29	22 32	0 16	2 10	4 07	6 15	8 17	10 15	12 07	13 58	16 03	18 15
26	20 33	22 36	0 20	2 14	4 11	6 19	8 21	10 19	12 11	14 02	16 07	18 19
27	20 37	22 40	0 23	2 18	4 15	6 23	8 25	10 23	12 14	14 06	16 12	18 23
28	20 42	22 43	0 27	2 21	4 19	6 27	8 29	10 26	12 18	14 09	16 16	18 28
29	20 46	22 46	0 31	2 25	4 23	6 31	8 33	10 30	12 22	14 13	16 20	18 32
30	20 50	..	0 34	2 29	4 27	6 36	8 37	10 33	12 25	14 17	16 25	18 37
31	20 54	..	0 38	..	4 31	..	8 41	10 37	..	14 21	..	18 41

TABLE IV.—MEAN PLACES OF 44 OF THE PRINCIPAL FIXED STARS FOR JANUARY 1ST, 1883.

Name.	Mag.	Right Asc.			Ann.Var	Declination.			Ann.Var.
		h.	m.	s.		°	'	"	
α Andromedæ	2	0	2	20.434	+3.09	+28	26	39.99	+19.90
γ Pegasi ... (<i>Algenib</i>) .. .	3,2	0	7	12.679	3.08	+14	31	58.21	20.02
α Cassiopeæ	2,3	0	33	52.403	3.37	+55	53	43.49	19.79
β Ceti	2	0	37	42.872	3.01	-18	38	45.05	19.80
α Ursæ Minoris ... (<i>Polaris</i>) ..	2	1	15	50.214	22.09	+88	41	5.88	18.96
α Eridani ... (<i>Achernar</i>) .. .	1	1	33	21.260	2.24	-57	49	53.45	18.38
α Arletis	2	2	0	34.694	3.37	+22	54	30.49	17.19
α Persæ	2	3	15	58.418	4.25	+49	26	36.05	13.11
α Tauri ... (<i>Aldebaran</i>) .. .	1	4	29	12.440	3.44	+16	16	22.30	7.57
α Aurigæ ... (<i>Capella</i>) .. .	1	5	8	2.822	4.42	+45	52	38.05	4.08
β Orionis ... (<i>Rigel</i>) .. .	1	5	8	54.867	2.88	-8	20	17.30	4.41
β Tauri	2	5	18	53.816	3.79	+28	30	25.03	3.38
α Columbæ	2	5	35	24.791	2.17	-14	8	14.78	2.11
α Orionis ... (<i>Belguese</i>) .. .	1	5	48	50.251	3.25	+7	23	1.70	0.98
α Argûs ... (<i>Canopus</i>) .. .	1	6	21	21.199	1.33	-52	37	55.84	-1.87
α Canis Majoris ... (<i>Sirius</i>) ..	1	6	39	59.518	2.65	-16	33	23.82	4.72
ϵ Canis Majoris	2,1	6	54	1.665	2.36	-28	48	49.70	4.70
α^2 Geminorum ... (<i>Castor</i>) ..	2,1	7	27	8.073	3.84	+32	8	37.76	7.52
α Canis Minoris ... (<i>Procyon</i>) ..	1	7	33	10.646	3.14	+5	31	24.05	9.01
β Geminorum ... (<i>Pollux</i>) ..	1,2	7	38	9.317	3.68	+28	18	27.13	8.39
ι Argûs	2	9	13	57.436	1.61	-58	47	4.12	15.02
α Hydræ	2	9	21	50.213	2.95	-8	9	8.09	15.43
α Leonis ... (<i>Regulus</i>) .. .	1,2	10	2	8.399	3.20	+12	32	18.65	17.45
η Argûs	1,6	10	40	31.399	2.31	-59	4	10.58	18.86
α Ursæ Majoris	2	10	56	29.965	3.75	+62	22	55.56	19.38
β Leonis	2	11	43	5.453	3.06	+15	13	33.79	20.10
γ Ursæ Majoris	2,3	11	47	40.397	3.18	+54	20	42.27	20.02
α^1 Ophiuchi	1	12	20	5.827	3.29	-62	27	0.89	19.99
α Virginis ... (<i>Spica</i>) .. .	1	13	19	1.725	3.15	-10	33	0.92	18.91
η Ursæ Majoris	2	13	42	55.813	2.37	+49	53	50.61	18.09
β Centauri	1	13	55	34.519	4.18	-59	48	28.01	17.61
α Bootis ... (<i>Arcturus</i>) .. .	1	14	10	19.503	2.73	+19	47	32.98	18.83
α^2 Centauri	1	14	31	39.161	4.01	-60	21	14.15	15.38
α Coronæ Borealis ... (<i>Alphecca</i>)	2	15	29	44.079	2.54	+27	6	33.39	12.30
β^1 Scorpil	2	15	58	38.050	3.47	-19	29	3.03	10.15
α Scorpil ... (<i>Antares</i>) .. .	1	16	22	14.060	3.67	-26	10	15.83	8.33
α Trianguli Australis	2	16	36	17.199	6.29	-68	48	37.49	7.20
α Ophiuchi	2	17	29	30.131	2.78	+12	38	46.84	2.86
α Lyræ ... (<i>Vega</i>) .. .	1	18	32	58.614	2.03	+38	40	31.09	+3.15
α Aquilæ ... (<i>Altair</i>) .. .	1,2	19	45	4.467	2.91	+8	33	36.56	9.25
α Pavonis	2	20	16	23.014	4.78	-57	6	29.28	11.20
α Gruis	2	22	0	51.173	3.81	-47	31	36.91	17.25
α Piscis Australis .. (<i>Pomalhaut</i>)	1,2	22	51	10.909	3.32	-30	14	32.23	18.97
α Pegasi ... (<i>Markab</i>) .. .	2	22	58	55.944	2.98	+14	34	33.71	19.32

In this table North Declination is denoted by +, South Declination by -; to reduce the declination to any other date the corrections must be applied algebraically.

LIST AND ONLY MEASUREMENTS OF THE STARS

Mag.	Stars.	Jan.	Feb.	March.	April.	May.	June.	July.	Aug.	Sept.	Oct.	Nov.	Dec.
		h. m.	h. m.	h. m.	h. m.	h. m.	h. m.	h. m.	h. m.	h. m.	h. m.	h. m.	h. m.
2	α Andromedæ	5 14	3 4	1 13	23 19	21 28	19 35	17 21	15 16	13 20	11 32	9 36	7 32
2,3	γ Pegasi ... (Algenib)	5 19	3 7	1 44	23 24	21 33	19 30	17 52	15 21	13 25	11 37	9 41	7 37
3	α Cassiopeæ	5 46	3 33	1 44	23 51	21 59	19 57	17 56	15 48	13 52	12 4	10 7	8 4
2,3	β Ceti	5 50	3 37	1 48	23 55	22 3	20 1	17 56	15 52	13 55	12 7	10 11	8 7
2,3	γ Ursæ Minoris ... (Polaris)	6 26	4 14	2 25	0 31	22 40	20 37	18 33	16 28	14 32	12 44	10 48	8 44
1	α Eridani ... (Achernar)	6 45	4 23	2 44	0 50	22 59	20 56	18 52	16 47	14 51	13 3	11 7	9 3
2,3	α Arctis	7 12	5 0	3 11	1 18	23 26	21 23	19 19	17 14	15 18	13 30	11 34	9 30
2,3	α Persæ	8 28	6 16	4 26	2 33	0 42	22 39	20 34	18 30	16 34	14 46	12 49	10 46
1	α Tauri ... (Aldebaran)	9 41	7 29	5 40	3 46	1 55	23 52	21 48	19 43	17 47	15 59	14 3	11 59
1	α Aurigæ ... (Capella)	10 20	8 8	6 19	4 25	2 34	0 31	22 27	20 22	18 26	16 38	14 41	12 38
1	β Orionis ... (Rigel)	10 21	8 9	6 19	4 25	2 34	0 31	22 27	20 22	18 26	16 38	14 41	12 38
1	β Tauri	10 31	8 18	6 29	4 36	2 44	0 58	22 37	20 33	18 37	16 49	14 52	12 48
3	α Columbæ	10 47	8 35	6 46	4 52	3 1	0 58	22 54	20 49	18 53	17 5	15 9	13 5
1	α Orionis ... (Betelgeuse)	11 1	8 48	6 59	5 6	3 14	1 12	23 7	21 3	19 7	17 19	15 22	13 18
1	α Argus ... (Tanogus)	11 33	9 21	7 32	5 38	3 47	1 44	23 40	21 35	19 39	17 51	15 55	13 51
1	α Canis Majoris ... (Sirius)	11 52	9 40	7 51	5 57	4 5	2 3	23 59	21 54	19 58	18 10	16 13	14 10
2	α Canis Majoris	12 6	9 54	8 5	6 11	4 20	2 17	0 13	22 8	20 12	18 24	16 28	14 24
2	α Geminorum ... (Castor)	12 39	10 27	8 38	6 44	4 53	2 50	0 46	22 41	20 45	18 57	17 1	14 57
1,2	γ Argus	15 52	13 40	11 51	9 58	8 6	6 3	3 59	1 54	23 58	22 10	20 14	18 10
1,2	β Canis Minoris ... (Procyon)	12 45	10 33	8 44	6 50	4 59	3 1	0 57	22 42	20 51	19 3	17 12	15 3
1	β Geminorum ... (Pollux)	12 50	10 38	8 49	6 55	5 4	3 1	0 57	22 52	20 56	19 8	17 12	15 8
2	α Argus	14 26	12 14	10 25	8 31	6 40	4 37	2 33	0 26	22 32	20 44	18 48	16 44
2	α Hydræ	14 34	12 21	10 32	8 39	6 47	4 45	2 40	0 36	22 40	20 52	18 56	16 51
2	α Leonis ... (Regulus)	15 14	13 2	11 13	9 19	7 28	5 25	3 21	1 16	23 21	21 32	19 36	17 32
1,2	γ Argus	15 52	13 40	11 51	9 58	8 6	6 3	3 59	1 54	23 58	22 10	20 14	18 10
1,2	α Ursæ Majoris	16 8	13 56	12 7	10 13	8 22	6 19	4 15	2 10	0 14	22 26	20 30	18 26
2	γ Leonis	16 55	14 43	12 54	11 0	9 9	7 6	5 2	2 57	1 1	23 13	21 17	19 13
2	γ Ursæ Majoris	16 59	14 47	12 58	11 5	9 13	7 10	5 6	3 1	1 5	23 17	21 21	19 17
1	γ Crucis	17 32	15 20	13 31	11 37	9 46	7 43	5 39	3 34	1 38	23 50	21 54	19 50
1	α Virginis ... (Spica)	18 31	16 19	14 30	12 36	10 45	8 42	6 38	4 33	2 37	0 49	22 52	20 49
2,3	γ Ursæ Majoris	18 55	16 43	14 54	13 0	11 9	9 6	7 2	4 57	3 1	1 13	23 16	21 13
1,2	β Centauri	19 7	16 55	15 6	13 12	11 21	9 18	7 14	5 9	3 13	1 25	23 29	21 25
1	α Bootis ... (Arcturus)	19 22	17 10	15 21	13 27	11 36	9 33	7 29	5 24	3 28	1 40	23 44	21 40
1	α Centauri	19 43	17 31	15 42	13 49	11 57	9 54	7 50	5 45	3 49	2 1	0 5	22 1
2,3	α Coronæ Borealis ... (Alphacca)	20 42	18 29	16 40	14 47	12 55	10 53	8 48	6 44	4 48	3 0	1 32	23 28
2	β Scorpii	21 10	18 58	17 9	15 16	13 24	11 21	9 17	7 12	5 16	3 28	1 32	23 28
2	α Scorpis ... (Antares)	21 34	19 22	17 33	15 39	13 48	11 45	9 41	7 36	5 40	3 52	1 56	23 52
2	α Trianguli Australis	21 48	19 16	17 47	15 53	14 2	11 59	9 55	7 50	5 45	4 6	2 9	0 59
2,3	α Ophiuchi	22 41	20 29	18 40	16 46	14 55	12 52	10 48	8 43	6 47	4 59	3 3	0 59
1	α Lyræ ... (Vega)	23 45	21 33	19 44	17 50	15 59	13 56	11 52	9 57	7 51	6 3	4 7	2 2
1,2	α Aquilæ ... (Altair)	0 57	22 45	20 56	19 02	17 11	15 8	13 4	10 59	9 3	7 15	5 19	3 15
2	α Pavonis	1 28	23 16	21 27	19 33	17 42	15 39	13 35	11 30	9 34	7 46	5 50	3 46
1,2	α Grulæ	3 13	1 0	23 11	21 18	19 26	17 24	15 19	13 15	11 19	9 31	7 34	5 30
1	α Piscis Australis ... (Fomalhaut)	4 3	1 51	0 2	22 8	20 17	18 14	16 10	14 5	12 9	10 21	8 25	6 21
2	α Pegasi ... (Miktab)	4 11	1 59	0 10	22 16	20 25	18 22	16 18	14 13	12 17	10 29	8 32	6 29

TABLE VI.—CORRECTION FOR THE DAY OF THE MONTH, TO BE *subtracted* FROM THE APPARENT TIME OF A STAR'S MERIDIAN PASSAGE ON THE FIRST DAY OF THE MONTH.

Days.	Jan.	Feb.	March.	April.	May.	June.	July.	Aug.	Sept.	Oct.	Nov.	Dec.
	h. m.	h. m.	h. m.	h. m.	h. m.	h. m.	h. m.	h. m.	h. m.	h. m.	h. m.	h. m.
1	0 0	0 0	0 0	0 0	0 0	0 0	0 0	0 0	0 0	0 0	0 0	0 0
2	0 4	0 4	0 4	0 4	0 4	0 4	0 4	0 4	0 4	0 4	0 4	0 4
3	0 9	0 8	0 7	0 7	0 8	0 8	0 8	0 8	0 7	0 7	0 8	0 9
4	0 13	0 12	0 11	0 11	0 11	0 12	0 12	0 12	0 11	0 11	0 12	0 13
5	0 18	0 16	0 15	0 15	0 15	0 16	0 16	0 15	0 14	0 15	0 16	0 17
6	0 22	0 20	0 19	0 18	0 19	0 21	0 21	0 19	0 18	0 18	0 20	0 22
7	0 26	0 24	0 22	0 22	0 23	0 25	0 25	0 23	0 22	0 22	0 24	0 26
8	0 30	0 28	0 26	0 26	0 27	0 29	0 29	0 27	0 25	0 25	0 28	0 30
9	0 35	0 32	0 30	0 29	0 30	0 33	0 33	0 31	0 29	0 29	0 32	0 35
10	0 39	0 36	0 33	0 33	0 35	0 37	0 37	0 35	0 32	0 33	0 36	0 39
11	0 43	0 40	0 37	0 36	0 39	0 41	0 41	0 38	0 36	0 37	0 40	0 44
12	0 48	0 44	0 41	0 40	0 42	0 45	0 45	0 42	0 40	0 40	0 44	0 48
13	0 52	0 48	0 44	0 44	0 46	0 49	0 49	0 46	0 43	0 44	0 48	0 52
14	0 56	0 52	0 48	0 48	0 50	0 54	0 53	0 50	0 47	0 48	0 52	0 57
15	1 1	0 56	0 52	0 51	0 54	0 58	0 57	0 53	0 50	0 51	0 56	1 1
16	1 5	1 0	0 55	0 55	0 58	1 2	1 1	0 57	0 54	0 55	1 0	1 6
17	1 9	1 3	0 59	0 59	1 2	1 6	1 5	1 1	0 58	0 59	1 4	1 10
18	1 13	1 7	1 2	1 2	1 6	1 10	1 9	1 5	1 1	1 3	1 9	1 15
19	1 18	1 11	1 6	1 6	1 10	1 14	1 13	1 8	1 5	1 6	1 13	1 19
20	1 22	1 15	1 10	1 10	1 14	1 19	1 17	1 12	1 8	1 10	2 17	1 24
21	1 26	1 19	1 14	1 13	1 18	1 23	1 21	1 16	1 12	1 14	1 21	1 28
22	1 31	1 23	1 17	1 17	1 22	1 27	1 25	1 19	1 16	1 18	1 25	1 32
23	1 35	1 26	1 21	1 21	1 26	1 31	1 29	1 23	1 19	1 21	1 30	1 37
24	1 39	1 30	1 24	1 25	1 30	1 35	1 33	1 27	1 23	1 25	1 34	1 41
25	1 43	1 34	1 28	1 28	1 34	1 39	1 37	1 31	1 26	1 29	1 38	1 46
26	1 47	1 38	1 32	1 32	1 38	1 44	1 41	1 34	1 30	1 33	1 42	1 50
27	1 51	1 42	1 35	1 36	1 42	1 48	1 45	1 38	1 34	1 37	1 47	1 55
28	1 56	1 45	1 39	1 40	1 46	1 52	1 49	1 42	1 37	1 41	1 51	1 59
29	2 0	..	1 43	1 44	1 50	1 56	1 53	1 45	1 41	1 44	1 53	2 3
30	2 4	..	1 46	1 47	1 55	2 0	1 57	1 49	1 44	1 48	1 59	2 8
31	2 8	..	1 50	..	1 59	..	2 1	1 52	..	1 52	..	2 12

TABLE IX.—DISTANCE OF THE SEA HORIZON UNCORRECTED FOR EFFECTS OF REFRACTION.*

Height.	Dis- tance.	Height.	Dis- tance.	Height.	Dis- tance.	Height.	Dis- tance.	Height.	Dis- tance.	Height.	Dis- tance.
Feet.		Feet.		Feet.		Feet.		Feet.		Feet.	
1·1	1	390	21	1487	41	3293	61	9032	101	17608	141
3·5	2	428	22	1561	42	3513	63	9393	103	18111	143
8·0	3	468	23	1636	43	3740	65	9760	105	18622	145
14·2	4	510	24	1713	44	3974	67	10135	107	19140	147
22·1	5	550	25	1792	45	4213	69	10518	109	19664	149
31·9	6	598	26	1872	46	4461	71	10908	111	20197	151
43·3	7	645	27	1954	47	4716	73	11304	113	20736	153
56·6	8	694	28	2039	48	4976	75	11709	115	21282	155
71·7	9	744	29	2124	49	5249	77	12120	117	21836	157
88·5	10	797	30	2212	50	5524	79	12538	119	22397	159
107	11	850	31	2301	51	5808	81	12966	121	22964	161
127	12	906	32	2393	52	6098	83	13397	123	23540	163
149	13	964	33	2485	53	6394	85	13836	125	24121	165
173	14	1023	34	2581	54	6700	87	14282	127	24711	167
199	15	1084	35	2677	55	7012	89	14737	129	25307	169
226	16	1147	36	2775	56	7332	91	15197	131	25911	171
256	17	1211	37	2875	57	7656	93	15664	133	26521	173
287	18	1278	38	2977	58	7987	95	16139	135	27139	175
319	19	1346	39	3081	59	8330	97	16622	137	27764	177
354	20	1416	40	3186	60	8678	99	17111	139	28396	179

(Approximately the distance visible in miles is the square root of the height in feet, an accidental relation easy to remember.)

* The effects of refraction at low angles are very variable, but in ordinary cases, if the height of observer be supposed to be increased by one-third, the distance of the visible sea horizon will not exceed the tabular value corresponding to the revised entry. Extraordinary cases are those of mirage, &c., for which no general rule can be given.

TABLE X.—Values of $\frac{2 \sin^2 \frac{1}{2} \text{hour } \angle}{\sin 1''}$.

		Hour Angles in Time.																				
Seconds.		0 ^m	1 ^m	2 ^m	3 ^m	4 ^m	5 ^m	6 ^m	7 ^m	8 ^m	9 ^m	10 ^m	11 ^m	12 ^m	13 ^m	14 ^m	15 ^m	16 ^m	17 ^m	18 ^m	19 ^m	
0	0	0	0	0	0	0	0	0	0	0	0	0	0	0	0	0	0	0	0	0	0	0
1	0	2	8	8	18	31	49	71	96	126	159	196	237	283	332	385	442	502	567	637	708	
2	0	2	8	18	32	49	71	97	126	157	190	227	268	314	363	416	473	534	599	668	740	
3	0	2	8	18	32	50	72	98	127	158	191	228	269	315	364	417	474	535	599	669	741	
4	0	2	8	18	32	50	72	98	128	159	192	229	270	316	365	418	475	536	599	670	742	
5	0	2	8	19	33	51	73	99	129	160	193	230	271	317	366	419	476	537	599	671	743	
6	0	2	9	19	33	51	73	99	129	160	193	230	271	317	366	419	476	537	599	671	744	
7	0	2	9	19	33	51	73	99	129	160	193	230	271	317	366	419	476	537	599	671	744	
8	0	2	9	19	33	52	74	100	130	161	194	231	272	318	367	420	477	538	599	672	744	
9	0	3	9	19	34	52	74	100	130	161	194	231	272	318	367	420	477	538	599	672	744	
10	0	3	9	20	34	52	75	101	131	162	195	232	273	319	368	421	478	539	599	673	744	
11	0	3	9	20	34	53	75	101	131	162	195	232	273	319	368	421	478	539	599	673	744	
12	0	3	9	20	35	53	75	102	132	163	196	233	274	320	369	422	479	540	599	674	744	
13	0	3	10	20	35	53	75	102	132	163	196	233	274	320	369	422	479	540	599	674	744	
14	0	3	10	20	35	54	76	103	133	164	197	234	275	321	370	423	480	540	599	674	744	
15	0	3	10	21	35	54	76	103	133	164	197	234	275	321	370	423	480	540	599	674	744	
16	0	3	10	21	36	54	77	104	134	165	198	235	276	322	371	424	481	541	599	675	744	
17	0	3	10	21	36	55	77	104	134	165	198	235	276	322	371	424	481	541	599	675	744	
18	0	3	10	21	36	55	77	105	135	166	199	236	277	323	372	425	482	542	599	675	744	
19	0	3	10	22	37	55	78	105	135	166	199	236	277	323	372	425	482	542	599	675	744	
20	0	3	11	22	37	56	79	106	136	167	200	237	278	324	373	426	483	543	599	676	744	
21	0	4	11	22	37	56	79	106	136	167	200	237	278	324	373	426	483	543	599	676	744	
22	0	4	11	22	38	57	80	107	137	168	201	238	279	325	374	427	484	544	599	676	744	
23	0	4	11	22	38	57	80	107	137	168	201	238	279	325	374	427	484	544	599	676	744	
24	0	4	11	23	38	58	81	108	138	169	202	239	280	326	375	428	485	545	599	677	744	
25	0	4	12	23	39	58	81	108	138	169	202	239	280	326	375	428	485	545	599	677	744	
26	0	4	12	23	39	58	82	109	140	171	204	241	281	327	376	429	486	546	599	678	744	
27	0	4	12	23	39	58	82	109	140	171	204	241	281	327	376	429	486	546	599	678	744	
28	0	4	12	24	39	59	82	109	141	171	204	241	281	327	376	429	486	546	599	678	744	

TABLE X.—continued.

Seconds.	Hour Angles in Time.																			
	0	1	2	3	4	5	6	7	8	9	10 ^m	11 ^m	12 ^m	13 ^m	14 ^m	15 ^m	16 ^m	17 ^m	18 ^m	19 ^m
29	0	4	12	24	39	59	82	110	141	177	216	259	306	357	412	470	533	600	670	745
30	1	4	12	24	40	59	83	110	142	177	216	260	307	358	413	471	534	601	671	746
31	1	4	12	24	40	60	84	111	142	178	217	260	307	359	414	473	535	602	673	747
32	1	5	13	24	40	60	84	111	143	178	218	261	308	359	415	474	536	603	674	749
33	1	5	13	25	41	60	84	112	143	179	218	262	309	360	415	475	538	604	675	750
34	1	5	13	25	41	61	85	112	144	180	219	263	310	361	416	476	539	606	676	751
35	1	5	13	25	41	61	85	113	145	180	220	263	311	362	417	477	540	607	678	753
36	1	5	13	25	41	62	85	113	145	181	221	264	312	363	418	478	541	608	679	754
37	1	5	13	26	42	62	86	114	146	182	221	265	312	364	419	479	542	609	680	755
38	1	5	14	26	42	62	86	114	146	182	222	266	313	365	420	480	543	610	681	756
39	1	5	14	26	42	63	87	115	147	183	223	266	314	366	421	481	544	611	683	758
40	1	5	14	26	43	63	87	115	147	183	223	267	315	367	422	482	545	612	684	759
41	1	6	14	27	43	63	88	116	148	184	224	268	316	367	423	483	546	614	685	760
42	1	6	14	27	43	64	88	116	149	185	225	269	317	368	424	484	547	615	686	761
43	1	6	14	27	44	64	89	117	149	185	225	269	317	369	425	485	548	616	687	763
44	1	6	15	27	44	64	89	117	150	186	226	270	318	370	426	486	549	617	689	764
45	1	6	15	28	44	65	89	118	150	187	227	271	319	371	427	487	551	618	690	765
46	1	6	15	28	45	65	90	118	151	188	228	272	320	372	428	488	552	619	691	767
47	1	6	15	28	45	66	90	119	151	188	228	273	321	373	429	489	553	621	692	768
48	1	6	15	28	45	66	91	119	152	188	229	273	322	374	430	490	554	622	694	769
49	1	6	16	29	45	66	91	120	153	189	230	274	322	375	431	491	555	623	695	771
50	1	7	16	29	46	67	92	120	153	190	230	275	323	376	432	492	556	624	696	772
51	1	7	16	29	46	67	92	121	154	190	231	276	324	377	433	493	557	625	697	773
52	2	7	16	29	46	68	93	121	154	191	232	276	325	378	434	494	558	626	698	774
53	2	7	16	30	47	68	93	122	155	192	232	277	326	378	435	495	559	628	700	776
54	2	7	16	30	47	68	93	122	155	192	233	278	327	379	435	496	560	629	701	777
55	2	7	17	30	47	69	94	123	156	193	234	279	327	380	437	497	562	630	702	778
56	2	7	17	30	48	69	94	124	157	194	235	279	328	381	438	498	563	631	703	780
57	2	7	17	31	48	69	95	124	157	194	235	280	329	382	439	499	564	632	705	781
58	2	8	17	31	48	70	95	125	158	195	236	281	330	383	440	500	565	633	706	782
59	2	8	17	31	49	70	96	125	158	196	237	282	331	384	441	501	566	635	707	784

TABLE XI.—NUMBER OF GEOGRAPHICAL MILES,* OR MINUTES OF THE EQUATOR, CONTAINED IN A DEGREE OF LONGITUDE UNDER EACH PARALLEL OF LATITUDE, ON THE SUPPOSITION OF THE EARTH'S SPHEROIDAL SHAPE WITH A COMPRESSION OF 304.

Parallel of Latitude.	Length of Degree.	Parallel of Latitude.	Length of Degree.	Parallel of Latitude.	Length of Degree.	Parallel of Latitude.	Length of Degree.	Parallel of Latitude.	Length of Degree.	Parallel of Latitude.	Length of Degree.	Parallel of Latitude.	Length of Degree.
0	60.000	0	51.475	0	41.750	0	29.161	0	14.560	0	29.161	0	14.560
1	59.991	31	50.930	46	40.992	61	28.240	62	13.539	76	28.240	77	13.539
2	59.984	32	50.370	47	40.220	63	27.310	64	12.514	78	27.310	79	12.514
3	59.918	33	49.793	48	39.437	64	26.372	65	11.485	79	26.372	80	11.485
4	59.854	34	49.202	49	38.642	65	25.426	66	10.452	80	25.426	81	10.452
5	59.773	35	48.596	50	37.834	66	24.471	67	9.416	81	24.471	82	9.416
6	59.673	36	47.975	51	37.015	67	23.509	68	8.377	82	23.509	83	8.377
7	59.556	37	47.339	52	36.185	68	22.540	69	7.336	83	22.540	84	7.336
8	59.419	38	46.688	53	35.343	69	21.564	70	6.292	84	21.564	85	6.292
9	59.266	39	46.021	54	34.400	70	20.581	71	5.246	85	20.581	86	5.246
10	59.094	40	45.346	55	33.627	71	19.592	72	4.199	86	19.592	87	4.199
11	58.905	41	44.654	56	32.754	72	18.596	73	3.150	87	18.596	88	3.150
12	58.697	42	43.948	57	31.870	73	17.595	74	2.101	88	17.595	89	2.101
13	58.472	43	43.229	58	30.977	74	16.588	75	1.050	89	16.588	90	1.050
14	58.229	44	42.475	59	30.074	75	15.577		0.000				0.000
15	57.968	45		60									

* To convert to Statute miles, multiply by 1.15.

TABLE XII.—TABLE FOR CONVERTING STATUTE INTO GEOGRAPHICAL MILES.

Stat. Miles.	Geo. Miles.	Stat. Miles.	Geo. Miles.	Stat. Miles.	Geo. Miles.	Stat. Miles.	Geo. Miles.
1'00	0'87	13'25	11'50	25'50	22'11	37'75	32'78
1'25	1'08	13'50	11'72	25'75	22'36	38'00	33'00
1'50	1'30	13'75	11'94	26'00	22'58	38'25	33'21
1'75	1'52	14'00	12'16	26'25	22'80	38'50	33'43
2'00	1'74	14'25	12'37	26'50	23'01	38'75	33'65
2'25	1'95	14'50	12'59	26'75	23'23	39'00	33'87
2'50	2'17	14'75	12'81	27'00	23'45	39'25	34'08
2'75	2'39	15'00	13'03	27'25	23'66	39'50	34'30
3'00	2'60	15'25	13'24	27'50	23'88	39'75	34'52
3'25	2'82	15'50	13'56	27'75	24'10	40'00	34'73
3'50	3'04	15'75	13'68	28'00	24'31	40'25	34'95
3'75	3'26	16'00	13'89	28'25	24'53	40'50	35'17
4'00	3'48	16'25	14'11	28'50	24'75	40'75	35'38
4'25	3'70	16'50	14'33	28'75	24'97	41'00	35'60
4'50	3'91	16'75	14'55	29'00	25'18	41'25	35'82
4'75	4'12	17'00	14'76	29'25	25'40	41'50	36'04
5'00	4'34	17'25	14'98	29'50	25'64	41'75	36'25
5'25	4'56	17'50	15'20	29'75	25'83	42'00	36'47
5'50	4'78	17'75	15'41	30'00	26'05	42'25	36'69
5'75	4'99	18'00	15'63	30'25	26'27	42'50	36'90
6'00	5'21	18'25	15'85	30'50	26'48	42'75	37'12
6'25	5'43	18'50	16'06	30'75	26'70	43'00	37'34
6'50	5'64	18'75	16'28	31'00	26'92	43'25	37'55
6'75	5'86	19'00	16'50	31'25	27'13	43'50	37'77
7'00	6'08	19'25	16'72	31'50	27'35	43'75	37'99
7'25	6'30	19'50	16'93	31'75	27'57	44'00	38'21
7'50	6'51	19'75	17'15	32'00	27'79	44'25	38'42
7'75	6'73	20'00	17'37	32'25	28'01	44'50	38'64
8'00	6'95	20'25	17'58	32'50	28'22	44'75	38'86
8'25	7'16	20'50	17'80	32'75	28'44	45'00	39'07
8'50	7'38	20'75	18'02	33'00	28'66	45'25	39'29
8'75	7'60	21'00	18'24	33'25	28'87	45'50	39'51
9'00	7'81	21'25	18'45	33'50	29'09	45'75	39'72
9'25	8'03	21'50	18'67	33'75	29'31	46'00	39'94
9'50	8'25	21'75	18'89	34'00	29'53	46'25	40'16
9'75	8'47	22'00	19'10	34'25	29'74	46'50	40'38
10'00	8'68	22'25	19'32	34'50	29'96	46'75	40'59
10'25	8'90	22'50	19'54	34'75	30'18	47'00	40'81
10'50	9'12	22'75	19'76	35'00	30'39	47'25	41'03
10'75	9'33	23'00	19'97	35'25	30'61	47'50	41'24
11'00	9'55	23'25	20'19	35'50	30'83	47'75	41'46
11'25	9'77	23'50	20'41	35'75	31'04	48'00	41'68
11'50	9'99	23'75	20'62	36'00	31'26	48'25	41'89
11'75	10'20	24'00	20'34	36'25	31'48	48'50	42'11
12'00	10'42	24'25	21'06	36'50	31'70	48'75	42'33
12'25	10'64	24'50	21'28	36'75	31'91	49'00	42'55
12'50	10'85	24'75	21'49	37'00	32'13	49'25	42'76
12'75	11'07	25'00	21'71	37'25	32'35	49'50	42'98
13'00	11'29	25'25	21'93	37'50	32'56	49'75	43'20
						50'00	43'42

TABLE XIII.—FOR CONVERTING GEOGRAPHICAL INTO STATUTE MILES.

Geo. Miles.	Stat. Miles.	Geo. Miles.	Stat. Miles.	Geo. Miles.	Stat. Miles.	Geo. Miles.	Stat. Miles.
1'00	1'15	13'25	15'26	25'50	29'36	37'75	43'34
1'25	1'44	13'50	15'54	25'75	29'66	38'00	43'63
1'50	1'73	13'75	15'83	26'00	29'94	38'25	43'92
1'75	2'01	14'00	16'12	26'25	30'23	38'50	44'20
2'00	2'30	14'25	16'41	26'50	30'52	38'75	44'49
2'25	2'59	14'50	16'70	26'75	30'81	39'00	44'78
2'50	2'88	14'75	16'98	27'00	31'09	39'25	45'07
2'75	3'17	15'00	17'27	27'25	31'38	39'50	45'35
3'00	3'45	15'25	17'56	27'50	31'67	39'75	45'64
3'25	3'74	15'50	17'85	27'75	31'95	40'00	45'93
3'50	4'03	15'75	18'14	28'00	32'24	40'25	46'21
3'75	4'32	16'00	18'42	28'25	32'53	40'50	46'50
4'00	4'61	16'25	18'71	28'50	32'81	40'75	46'79
4'25	4'89	16'50	19'00	28'75	33'10	41'00	47'07
4'50	5'18	16'75	19'28	29'00	33'39	41'25	47'36
4'75	5'47	17'00	19'57	29'25	33'68	41'50	47'66
5'00	5'76	17'25	19'86	29'50	33'96	41'75	47'95
5'25	6'04	17'50	20'15	29'75	34'25	42'00	48'23
5'50	6'33	17'75	20'44	30'00	34'54	42'25	48'52
5'75	6'62	18'00	20'73	30'25	34'82	42'50	48'81
6'00	6'91	18'25	21'01	30'50	35'11	42'75	49'09
6'25	7'20	18'50	21'30	30'75	35'40	43'00	49'38
6'50	7'48	18'75	21'59	31'00	35'68	43'25	49'67
6'75	7'77	19'00	21'88	31'25	35'97	43'50	49'95
7'00	8'06	19'25	22'17	31'50	36'26	43'75	50'24
7'25	8'35	19'50	22'45	31'75	36'55	44'00	50'53
7'50	8'64	19'75	22'74	32'00	36'83	44'25	50'82
7'75	8'92	20'00	23'03	32'25	37'12	44'50	51'10
8'00	9'21	20'25	23'32	32'50	37'41	44'75	51'39
8'25	9'50	20'50	23'61	32'75	37'69	45'00	51'68
8'50	9'79	20'75	23'89	33'00	37'98	45'25	51'96
8'75	10'07	21'00	24'18	33'25	38'27	45'50	52'25
9'00	10'36	21'25	24'47	33'50	38'55	45'75	52'54
9'25	10'65	21'50	24'76	33'75	38'84	46'00	52'83
9'50	10'94	21'75	25'04	34'00	39'13	46'25	53'11
9'75	11'23	22'00	25'33	34'25	39'42	46'50	53'40
10'00	11'51	22'25	25'62	34'50	39'70	46'75	53'69
10'25	11'80	22'50	25'91	34'75	39'99	47'00	53'97
10'50	12'09	22'75	26'20	35'00	40'28	47'25	54'26
10'75	12'38	23'00	26'48	35'25	40'56	47'50	54'54
11'00	12'67	23'25	26'77	35'50	40'85	47'75	54'83
11'25	12'95	23'50	27'06	35'75	41'13	48'00	55'12
11'50	13'24	23'75	27'35	36'00	41'42	48'25	55'41
11'75	13'53	24'00	27'64	36'25	41'72	48'50	55'70
12'00	13'82	24'25	27'92	36'50	42'01	48'75	55'98
12'25	14'11	24'50	28'21	36'75	42'30	49'00	56'27
12'50	14'39	24'75	28'50	37'00	42'58	49'25	56'56
12'75	14'68	25'00	28'79	37'25	42'77	49'50	56'84
13'00	14'97	25'25	29'07	37'50	43'06	49'75	57'13
						50'00	57'42

TABLE XIV.—COMPARISON OF THERMOMETER SCALES.

Fahrenheit.	Réaumur.	Centigrade.	Fahrenheit.	Réaumur.	Centigrade.	Fahrenheit.	Réaumur.	Centigrade.
0	0	0	33	+ 0·4	+ 0·6	67	+ 15·6	+ 19·4
0	-14·2	-17·8	34	0·9	1·1	68	16·0	20·0
1	13·8	17·2	35	1·3	1·7	69	16·4	20·6
2	13·3	16·7	36	1·8	2·2	70	16·9	21·1
3	12·9	16·1	37	2·2	2·8	71	17·3	21·7
4	12·4	15·6	38	2·7	3·3	72	17·8	22·2
5	12·0	15·0	39	3·1	3·9	73	18·2	22·8
6	11·6	14·4	40	3·6	4·4	74	18·7	23·3
7	11·1	13·9	41	4·0	5·0	75	19·1	23·9
8	10·7	13·3	42	4·4	5·6	76	19·6	24·4
9	10·2	12·8	43	4·9	6·1	77	20·0	25·0
10	9·8	12·2	44	5·3	6·7	78	20·4	25·6
11	9·3	11·7	45	5·8	7·2	79	20·9	26·1
12	8·9	11·1	46	6·2	7·8	80	21·3	26·7
13	8·4	10·6	47	6·7	8·3	81	21·8	27·2
14	8·0	10·0	48	7·1	8·9	82	22·2	27·8
15	7·6	9·4	49	7·6	9·4	83	22·7	28·3
16	7·1	8·9	50	8·0	10·0	84	23·1	28·9
17	6·7	8·3	51	8·4	10·6	85	23·6	29·4
18	6·2	7·8	52	8·9	11·1	86	24·0	30·0
19	5·8	7·2	53	9·3	11·7	87	24·4	30·6
20	5·3	6·7	54	9·8	12·2	88	24·9	31·1
21	4·9	6·1	55	10·2	12·8	89	25·3	31·7
22	4·4	5·6	56	10·7	13·3	90	25·8	32·2
23	4·0	5·0	57	11·1	13·9	91	26·2	32·8
24	3·6	4·4	58	11·6	14·4	92	26·7	33·3
25	3·1	3·9	59	12·0	15·0	93	27·1	33·9
26	2·7	3·3	60	12·4	15·6	94	27·6	34·4
27	2·2	2·8	61	12·9	16·1	95	28·0	35·0
28	1·8	2·2	62	13·3	16·7	96	28·4	35·6
29	1·3	1·7	63	13·8	17·2	97	28·9	36·1
30	0·9	1·1	64	14·2	17·8	98	29·3	36·7
31	- 0·4	- 0·6	65	14·7	18·3	99	29·8	37·2
32	0·0	0·0	66	+ 15·1	+ 18·9	100	+ 30·2	+ 37·8

$$x^{\circ} \text{ Réaumur} = (32^{\circ} + \frac{2}{3} x^{\circ}) \text{ Fahrenheit} = \frac{4}{3} x^{\circ} \text{ Centigrade.}$$

$$x^{\circ} \text{ Centigrade} = (32^{\circ} + \frac{2}{3} x^{\circ}) \text{ Fahrenheit} = \frac{3}{2} x^{\circ} \text{ Réaumur.}$$

$$x^{\circ} \text{ Fahrenheit} = \frac{3}{2}(x^{\circ} - 32) \text{ Réaumur} = \frac{3}{2}(x^{\circ} - 32^{\circ}) \text{ Centigrade.}$$

TABLE XV.—FOR CONVERTING ENGLISH INCHES AND TENTHS INTO MILLIMETERS

English inches and tenths.	Millim.	English inches and tenths.	Millim.	English inches and tenths.	Millim.	English inches and tenths.	Millim.	English inches and tenths.	Millim.
12·0	304·79	16·0	406·39	20·0	507·99	24·0	609·59	28·0	711·19
1	307·33	1	408·93	1	510·53	1	612·13	1	713·73
2	309·87	2	411·47	2	513·07	2	614·67	2	716·27
3	312·41	3	414·01	3	515·61	3	617·21	3	718·81
4	314·95	4	416·55	4	518·15	4	619·75	4	721·35
5	317·49	5	419·09	5	520·69	5	622·29	5	723·89
6	320·03	6	421·63	6	523·23	6	624·83	6	726·43
7	322·57	7	424·17	7	525·77	7	627·37	7	728·97
8	325·11	8	426·71	8	528·31	8	629·91	8	731·51
9	327·65	9	429·25	9	530·85	9	632·45	9	734·05
13·0	330·19	17·0	431·79	21·0	533·39	25·0	634·99	29·0	736·59
1	332·73	1	434·33	1	535·93	1	637·53	1	739·13
2	335·27	2	436·87	2	538·47	2	640·07	2	741·67
3	337·81	3	439·41	3	541·01	3	642·61	3	744·21
4	340·35	4	441·95	4	543·55	4	645·15	4	746·75
5	342·89	5	444·49	5	546·09	5	647·69	5	749·29
6	345·43	6	447·03	6	548·63	6	650·23	6	751·83
7	347·97	7	449·57	7	551·17	7	652·77	7	754·37
8	350·51	8	452·11	8	553·71	8	655·31	8	756·91
9	353·05	9	454·65	9	556·25	9	657·85	9	759·45
14·0	355·59	18·0	457·19	22·0	558·79	26·0	660·39	30·0	761·99
1	358·13	1	459·73	1	561·33	1	662·93	1	764·53
2	360·67	2	462·27	2	563·87	2	665·47	2	767·07
3	363·21	3	464·81	3	566·41	3	668·01	3	769·61
4	365·75	4	467·35	4	568·95	4	670·55	4	772·15
5	368·29	5	469·89	5	571·49	5	673·09	5	774·69
6	370·83	6	472·43	6	574·03	6	675·63	6	777·23
7	373·37	7	474·97	7	576·57	7	678·17	7	779·77
8	375·91	8	477·51	8	579·11	8	680·71	8	782·31
9	378·45	9	480·05	9	581·65	9	683·25	9	784·85
15·0	380·99	19·0	482·59	23·0	584·19	27·0	685·79	31·0	787·39
1	383·53	1	485·13	1	586·73	1	688·33	1	789·93
2	386·07	2	487·67	2	589·27	2	690·87	2	792·47
3	388·61	3	490·21	3	591·81	3	693·41	3	795·01
4	391·15	4	492·75	4	594·35	4	695·95	4	797·55
5	393·69	5	495·29	5	596·89	5	698·49		
6	396·23	6	497·83	6	599·43	6	701·03		
7	398·77	7	500·37	7	601·97	7	703·57		
8	401·31	8	502·91	8	604·51	8	706·11		
9	403·85	9	505·45	9	607·05	9	708·65		

PARTS TO BE ADDED FOR HUNDREDTHS OF AN INCH.

1	2	3	4	5	6	7	8	9
·254	·508	·762	1·016	1·270	1·524	1·778	2·032	2·286

TABLE XVI.—Nat. Cosines.

°	0°		1°		2°		3°		4°		5°	
	Co-sine.	Parts for "	Co-sine.	Parts for "	Co-sine.	Parts for "	Co-sine.	Parts for "	Co-sine.	Parts for "	Co-sine.	Parts for "
0	000000	0	999848	0	999891	0	999830	0	997564	0	996195	0
1	00	0	843	0	831	0	614	0	544	0	6169	0
2	00	0	837	0	370	0	599	1	523	1	6144	1
3	00	0	832	0	360	1	584	1	508	1	6118	1
4	999999	0	827	0	350	1	568	1	482	1	6093	2
5	99	0	821	0	339	1	552	1	462	2	6067	2
6	99	0	816	0	328	1	537	2	441	2	6041	3
7	98	0	810	1	318	1	521	2	420	3	6015	3
8	97	1	804	1	307	1	505	2	399	3	5989	3
9	97	1	799	1	296	2	489	2	378	3	5963	4
10	96	1	793	1	285	2	473	3	357	4	5937	4
11	999995	1	999757	1	999274	2	998457	3	997396	4	996911	5
12	94	1	781	2	263	2	441	3	315	4	894	5
13	93	1	774	1	252	2	425	4	293	5	858	6
14	92	1	768	1	240	3	408	4	272	5	832	6
15	91	1	763	2	229	3	392	4	250	5	805	7
16	89	1	756	2	218	3	375	4	229	6	778	7
17	88	1	749	2	206	3	359	4	207	6	752	7
18	86	1	743	2	194	3	342	5	185	6	725	8
19	85	1	736	2	183	4	325	5	163	7	698	8
20	83	1	729	2	171	4	308	5	141	7	671	9
21	999981	1	999722	2	999159	4	998291	6	997119	7	996644	9
22	80	2	716	2	147	4	274	6	7097	8	617	10
23	78	2	709	2	135	4	257	6	7075	8	589	10
24	76	2	701	3	123	5	240	7	7053	8	562	11
25	74	2	694	3	111	5	223	7	7030	9	535	11
26	71	2	687	3	998	5	205	7	7008	9	507	11
27	69	2	680	3	886	5	188	8	6985	10	480	12
28	67	2	672	3	773	5	170	8	6963	10	452	12
29	64	2	665	3	661	6	153	8	6940	11	424	13
30	62	2	657	3	548	6	135	9	6917	11	396	14
31	999959	2	999650	4	999036	7	998117	9	996895	12	996368	15
32	57	2	642	4	9023	7	8099	10	872	13	340	15
33	54	2	634	4	9010	7	8061	10	849	13	312	16
34	51	2	626	4	8997	8	8063	11	825	14	284	16
35	48	2	618	4	8984	8	8045	11	802	14	256	17
36	45	2	610	5	8971	8	8027	11	779	15	227	18
37	42	2	602	5	8957	9	8008	12	756	15	199	18
38	39	2	594	5	8944	9	7990	12	732	16	171	19
39	36	2	585	5	8931	9	7972	12	709	16	142	19
40	32	2	577	6	8917	9	7953	13	685	16	113	20
41	999929	2	999593	6	998904	10	997984	13	996681	17	996084	20
42	925	2	560	6	890	10	818	13	637	17	5056	21
43	922	2	551	6	876	10	897	14	614	17	5027	21
44	918	2	542	6	862	10	878	14	590	18	4998	21
45	914	3	534	6	849	11	859	14	566	18	4969	22
46	911	3	525	6	834	11	840	15	541	19	4939	23
47	907	3	516	7	820	11	821	15	517	19	4910	23
48	903	3	507	7	806	11	802	15	493	20	4881	23
49	898	3	497	7	792	11	782	16	469	20	4851	24
50	894	3	488	7	778	12	763	16	444	20	4822	25
51	999890	3	999479	7	998763	12	997743	16	996420	21	994792	25
52	886	3	469	7	749	12	724	16	393	21	763	26
53	881	3	460	7	734	12	704	17	370	22	733	26
54	877	3	451	8	719	13	684	17	345	22	708	27
55	872	3	441	8	705	13	665	17	320	22	673	27
56	867	3	431	8	690	13	645	18	295	23	643	28
57	863	3	421	8	675	14	625	18	270	23	613	28
58	858	3	411	8	660	14	605	18	245	24	583	29
59	853	3	401	8	645	14	584	19	220	24	552	29
60	848	4	391	9	630	14	564	19	195	24	522	29

TABLE XVI.—Nat. Cosines.

TABLE XVI.—Nat. Cosines.

#	6°		7°		8°		9°		10°		11°	
	Co-sine.	Parts for "	Co-sine.	Parts for "	Co-sine.	Parts for "	Co-sine.	Parts for "	Co-sine.	Parts for "	Co-sine.	Parts for "
0	994522	0	992546	0	990288	0	987834	0	984908	0	981627	0
1	491	1	511	1	0228	1	643	1	737	1	572	1
2	461	1	475	1	0187	1	697	1	707	2	616	2
3	430	2	439	2	0146	2	551	2	6'6	3	460	3
4	400	2	404	2	0108	3	500	3	6'6	3	405	4
5	369	3	382	3	0065	3	460	4	554	4	349	5
6	338	3	332	4	0024	4	414	5	503	5	293	6
7	307	4	296	4	989933	5	368	6	452	6	237	7
8	276	4	260	5	9942	6	322	7	401	7	181	7
9	245	5	224	6	9910	6	275	8	350	8	124	8
10	214	5	187	6	9859	7	229	8	299	9	062	9
11	994182	6	992151	7	989818	8	987183	9	984247	9	981012	10
12	4151	6	2115	7	776	8	7138	10	4196	10	0935	11
13	4120	7	2078	8	735	9	7090	11	4144	11	0899	12
14	4088	7	2042	9	693	10	7043	12	4092	12	0842	13
15	4056	8	2005	9	651	10	6996	12	4041	13	0786	14
16	4025	8	1968	10	610	11	6950	13	3989	14	0729	15
17	3993	9	1931	10	568	12	6903	13	3937	15	0672	16
18	3961	9	1894	11	526	12	6856	14	3885	16	0615	17
19	3929	10	1857	12	484	13	6809	15	3833	16	0558	18
20	3897	10	1820	12	442	14	6762	15	3781	17	0501	19
21	993865	11	991783	13	989399	14	986714	16	983729	18	980443	20
22	833	11	746	13	857	15	667	17	676	19	0366	21
23	800	12	709	14	815	16	620	18	624	20	0329	22
24	768	13	671	15	272	17	572	19	572	21	0271	23
25	736	13	634	15	250	17	527	19	519	22	0214	24
26	703	14	596	16	157	18	477	20	466	22	0166	25
27	670	14	558	17	145	19	429	21	414	23	0098	26
28	638	15	521	17	102	19	382	22	361	24	0041	27
29	605	15	483	18	059	20	334	23	308	25	979923	28
30	572	16	445	19	016	21	286	24	256	26	9925	29
31	993539	17	991407	20	988973	22	986288	25	983202	27	979867	30
32	506	18	369	21	930	23	6189	26	3149	28	869	31
33	473	19	331	22	887	24	6147	27	3066	29	760	32
34	440	19	292	22	843	25	6093	28	3042	30	692	33
35	406	20	254	23	800	26	6045	29	2989	31	634	34
36	373	21	216	24	756	26	5996	30	2935	32	573	35
37	339	21	177	24	713	27	5942	31	2882	33	517	36
38	306	22	138	25	669	28	5899	32	2828	34	458	37
39	272	22	100	26	626	28	5850	33	2774	35	399	38
40	238	23	061	26	582	29	5801	33	2721	36	341	39
41	993205	23	991022	27	985538	30	982752	34	979667	37	976282	40
42	3171	24	983	28	494	31	704	35	613	38	9223	41
43	3137	24	944	28	450	32	654	35	559	39	9164	42
44	3103	25	905	29	406	32	605	36	506	40	9105	43
45	3069	24	866	30	362	33	558	37	450	41	9046	44
46	3034	26	827	30	317	34	507	38	396	41	8986	45
47	3000	27	787	31	273	35	457	39	342	42	8927	46
48	2966	28	748	32	228	35	408	40	287	43	8867	47
49	2931	28	708	32	184	36	358	41	233	44	8808	48
50	2896	29	669	33	139	37	309	42	178	45	8748	49
51	992862	29	990629	34	988095	38	985259	42	982124	46	978689	50
52	827	30	589	34	8050	38	5209	43	2069	47	629	51
53	792	30	549	35	8005	39	5159	44	2014	48	569	52
54	757	31	510	36	7960	40	5109	45	1959	49	509	54
55	722	31	469	36	7915	41	5059	45	1904	50	449	55
56	687	32	429	37	7870	41	5009	46	1849	50	389	56
57	652	32	389	38	7825	42	4959	47	1793	51	329	57
58	617	33	349	38	7779	43	4909	48	1738	52	268	58
59	582	34	309	39	7734	44	4858	49	1683	53	208	59
60	546	34	269	39	7689	44	4808	50	1627	54	148	60

TABLE XVI.—Nat. Cosines.

TABLE XVI.—Nat. Cosines.

°	12°		13°		14°		15°		16°		17°	
	Co-sine.	Parts for "	Co-sine.	Parts for "	Co-sine.	Parts for "	Co-sine.	Parts for "	Co-sine.	Parts for "	Co-sine.	Parts for "
0	978148	0	974370	0	970296	0	965926	0	961262	0	956305	0
1	9087	1	4305	1	0225	1	850	1	1182	1	6220	1
2	8026	2	4239	2	0155	2	775	2	1104	3	6135	3
3	7968	3	4173	3	0084	3	700	4	1021	4	6049	4
4	7906	4	4108	4	0014	5	624	5	0940	5	5964	6
5	7844	5	4042	6	989943	6	548	6	0860	6	5879	7
6	7783	6	3976	6	9872	7	473	8	0779	8	5793	9
7	7722	7	3910	8	9801	8	397	9	0698	9	5707	10
8	7661	8	3844	9	9730	9	321	10	0618	11	5622	11
9	7600	9	3778	10	9659	10	245	11	0537	12	5536	13
10	7539	10	3712	11	9588	12	169	12	0456	14	5450	14
11	977477	11	973645	13	969617	13	965098	14	960378	15	955364	16
12	7416	12	579	14	9445	14	5016	15	0294	16	5278	17
13	7354	13	512	15	9374	15	4940	16	0218	18	5192	19
14	7293	14	446	16	9302	16	4864	18	0131	19	5106	20
15	7231	15	379	17	9231	18	4787	19	0050	20	5020	22
16	7169	16	313	18	9159	19	4711	20	969968	22	4934	23
17	7108	17	246	19	9088	20	4634	21	9637	23	4847	24
18	7046	18	179	20	9016	21	4557	23	9605	24	4761	26
19	6984	19	112	21	8944	22	4481	24	9574	26	4674	27
20	6922	20	045	22	8872	24	4404	26	9642	27	4588	29
21	976859	22	972978	24	968900	25	964827	27	960660	28	954501	30
22	797	23	911	25	728	26	4250	28	9478	30	4414	32
23	735	24	843	26	656	27	4178	29	9396	31	4327	33
24	672	25	778	27	588	28	4095	31	9314	32	4240	35
25	610	26	708	28	511	30	4018	32	9232	34	4153	36
26	547	27	641	29	438	31	3941	33	9150	35	4066	37
27	485	28	573	30	368	32	3863	34	9067	36	3979	39
28	422	29	506	31	298	33	3786	36	8985	38	3892	40
29	359	30	439	32	229	34	3708	37	8902	39	3804	42
30	296	31	370	34	148	36	3631	38	8820	41	3717	44
31	976233	32	972802	35	968075	37	963563	40	958737	43	953629	45
32	6170	33	2234	36	8002	38	3475	42	8854	44	3542	47
33	6107	35	2168	38	7929	40	3397	43	8872	46	3454	48
34	6044	36	2098	39	7856	41	3319	44	8489	47	3366	50
35	5981	37	2023	40	7783	43	3241	46	8406	49	3279	51
36	5917	38	1951	41	7709	44	3163	47	8323	50	3191	53
37	5853	39	1883	42	7636	45	3084	48	8239	51	3103	55
38	5790	40	1824	44	7562	47	3006	49	8156	53	3015	56
39	5726	41	1755	45	7489	48	2928	51	8073	54	2926	58
40	5662	42	1687	46	7415	49	2849	52	7990	55	2838	59
41	975599	43	971618	47	967342	50	962770	53	957906	57	952750	61
42	535	44	1549	48	7268	52	692	55	823	68	2662	62
43	471	45	1490	49	7194	53	613	56	739	59	2573	64
44	407	46	1411	50	7120	54	534	57	655	61	2484	65
45	342	47	1342	52	7046	55	455	59	571	62	2396	67
46	278	49	1273	53	6972	57	378	60	488	64	2307	68
47	214	50	1204	54	6898	58	297	61	404	65	2218	70
48	149	51	1134	55	6823	59	218	63	320	66	2129	71
49	085	52	1065	56	6749	60	139	64	235	68	2040	73
50	020	53	0995	57	6675	62	069	65	151	69	1951	74
51	974956	54	970926	59	966601	63	961980	67	957067	71	951862	76
52	891	55	856	60	6526	64	901	68	6963	72	773	77
53	826	56	786	61	6451	65	821	69	6898	74	684	79
54	761	57	717	62	6376	66	741	71	6814	76	594	80
55	696	58	647	63	6301	68	662	72	6729	77	505	82
56	631	59	577	64	6226	69	582	73	6644	78	415	83
57	566	60	507	66	6151	70	502	75	6560	80	326	85
58	501	61	437	67	6076	72	422	76	6475	81	236	86
59	436	62	368	68	6001	73	342	78	6390	82	146	88
60	370	64	298	69	5926	74	262	79	6305	83	057	89

TABLE XVI.—Nat. Cosines.

TABLE XVI.—Nat. Cosines.

°	18°		19°		20°		21°		22°		23°	
	Co-sine.	Parts for "	Co-sine.	Parts for "	Co-sine.	Parts for "	Co-sine.	Parts for "	Co-sine.	Parts for "	Co-sine.	Parts for "
0	951057	0	945519	0	939693	0	933590	0	927184	0	920505	0
1	0967	2	5424	2	9593	2	3478	2	7075	2	0391	2
2	0677	3	5329	3	9494	3	3372	4	6966	4	0277	4
3	0787	5	5234	5	9394	5	3267	5	6857	5	0164	6
4	0696	6	5139	6	9294	7	3163	7	6747	7	0050	8
5	0606	8	5044	8	9194	8	3058	9	6638	9	919938	10
6	0516	9	4949	10	9094	10	2954	11	6529	11	9822	11
7	0425	11	4854	11	8994	12	2849	12	6419	13	9707	13
8	0335	12	4758	13	8894	13	2744	14	6310	15	9593	15
9	0244	14	4663	14	8794	15	2639	16	6200	17	9479	17
10	0154	15	4568	16	8694	17	2534	18	6090	18	9364	19
11	950063	17	944472	18	938693	18	932429	19	925981	20	919250	21
12	949972	18	4378	19	8493	20	2324	21	5571	22	9135	23
13	9681	20	4281	21	8393	22	2219	23	5761	24	9021	25
14	9790	21	4185	22	8292	23	2113	25	5651	26	8906	27
15	9699	23	4089	24	8191	25	2008	26	5541	28	8791	29
16	9608	24	3993	26	8091	27	1902	23	5430	29	8676	31
17	9517	26	3897	27	7990	28	1797	30	5320	31	8561	33
18	9426	27	3801	29	7889	30	1691	32	5210	33	8446	35
19	9334	29	3705	30	7788	32	1586	33	5099	35	8331	37
20	9243	30	3609	32	7687	34	1480	35	4989	37	8216	38
21	949151	32	943512	34	937586	35	931374	37	924878	39	918101	40
22	9060	33	3416	35	7435	37	1268	39	4768	40	7986	42
23	8968	35	3319	37	7383	39	1162	40	4657	42	7870	44
24	8876	36	3223	38	7282	40	1056	42	4546	44	7755	46
25	8784	38	3126	40	7181	42	950	44	4435	46	7639	48
26	8692	39	3029	42	7079	44	843	46	4324	48	7523	50
27	8600	41	2932	43	6977	46	737	48	4213	50	7408	52
28	8508	42	2836	45	6876	47	631	50	4102	52	7292	54
29	8416	44	2739	47	6774	49	524	52	3991	54	7176	56
30	8324	46	2642	48	6672	51	418	53	3880	56	7060	58
31	948231	48	942544	51	936570	53	930311	55	923768	58	916941	60
32	8139	50	2447	52	6468	55	0204	57	3657	60	6828	62
33	8046	51	2350	54	6366	57	0097	59	3545	62	6712	64
34	7954	53	2253	56	6264	58	929991	61	3434	64	6596	66
35	7861	54	2155	57	6162	60	9884	63	3322	65	6479	68
36	7768	56	2058	59	6060	62	9777	65	3210	67	6363	70
37	7676	57	1960	60	5957	63	9669	67	3098	69	6246	72
38	7583	59	1862	62	5855	65	9562	69	2987	71	6130	74
39	7490	61	1764	64	5752	67	9455	71	2875	73	6013	76
40	7397	62	1667	66	5650	69	9348	72	2762	75	5896	78
41	917304	64	941569	67	935547	70	929240	74	922650	77	915780	80
42	7210	65	1471	69	5444	72	9183	76	2538	79	5663	82
43	7117	67	1372	71	5341	74	9025	78	2426	81	5546	84
44	7024	68	1274	72	5238	75	8917	80	2313	83	5429	86
45	6930	70	1176	74	5135	77	8810	81	2201	84	5312	88
46	6837	71	1078	75	5032	79	8702	83	2088	86	5194	90
47	6743	73	979	77	4929	81	8594	85	1976	88	5077	92
48	6649	75	881	79	4826	82	8486	87	1863	90	4960	94
49	6556	76	782	80	4722	84	8378	89	1750	92	4842	96
50	6462	78	684	82	4619	86	8270	90	1638	94	4725	98
51	946368	79	940586	84	934515	87	928161	92	921525	96	914607	100
52	6274	81	0496	85	4412	89	8053	94	1412	98	4490	102
53	6180	82	0387	87	4308	91	794	96	1299	100	4372	104
54	6085	84	0288	89	4205	93	7836	98	1185	101	4254	106
55	5991	85	0189	90	4101	95	7728	100	1072	103	4136	108
56	5897	87	0090	92	3997	98	7619	101	0959	105	4018	110
57	5802	88	999991	94	3893	98	7510	103	0846	107	3900	112
58	5708	90	9891	95	3789	100	7402	105	0732	109	3782	114
59	5618	92	9792	97	3685	101	7293	107	0619	110	3664	116
60	5519	93	9693	98	3580	103	7184	109	0505	112	3546	118

TABLE XVI.—Nat. Cosines.

TABLE XVI.—Nat. Cosines.

°	24°		25°		26°		27°		28°		29°	
	Co-sine.	Parts for "	Co-sine.	Parts for "	Co-sine.	Parts for "	Co-sine.	Parts for "	Co-sine.	Parts for "	Co-sine.	Parts for "
0	913546	0	906306	0	898794	0	891007	0	882949	0	874620	0
1	3427	2	6186	2	8697	2	0874	2	2811	2	4479	2
2	3309	4	6062	4	8539	4	0742	4	2674	4	4338	4
3	3190	6	5939	6	8411	6	0610	6	2538	6	4198	6
4	3072	8	5815	8	8283	8	0478	8	2401	8	4055	8
5	2953	10	5692	10	8156	11	0345	11	2264	11	3914	12
6	2834	12	5569	12	8028	13	0213	13	2127	13	3772	14
7	2715	14	5445	14	7900	15	0080	15	1990	15	3631	16
8	2597	16	5322	16	7772	17	98948	17	1853	18	3489	19
9	2478	18	5198	18	7643	19	9815	19	1716	21	3348	21
10	2358	20	5075	21	7515	21	9682	21	1578	23	3206	24
11	912239	22	4951	23	897387	23	989549	23	981441	25	873064	26
12	3120	24	4827	25	7258	26	9416	26	1304	27	2922	29
13	3001	26	4703	27	7130	28	9283	28	1168	30	2780	31
14	1882	28	4579	29	7001	30	9150	30	1028	32	2638	33
15	1762	30	4455	31	6873	32	9017	32	0891	34	2498	36
16	1643	32	4331	33	6744	34	8884	35	0753	37	2354	38
17	1523	34	4207	35	6615	36	8751	37	0615	39	2212	40
18	1403	36	4083	37	6486	38	8617	39	0477	41	2069	43
19	1284	38	3958	39	6358	40	8484	41	0339	43	1927	45
20	1164	40	3834	41	6229	43	8350	44	0201	46	1784	47
21	911044	42	398709	43	898099	45	888217	46	890068	48	871842	49
22	0924	44	3853	45	5970	47	8763	48	879925	52	1499	52
23	0804	46	3730	47	5841	49	7949	50	9787	54	1357	54
24	0684	48	3605	49	5712	52	7815	52	9649	58	1214	56
25	0564	50	3481	51	5582	54	7682	55	9510	58	1071	59
26	0443	52	3356	54	5453	57	7548	58	9372	60	0928	61
27	0323	54	3231	56	5323	58	7413	60	9233	62	0785	64
28	0202	56	2936	58	5194	60	7279	62	9095	64	0642	66
29	0082	58	2711	60	5064	62	7145	64	8956	67	0499	69
30	909961	60	2585	63	4934	65	7011	67	8817	69	0356	71
31	909841	62	902480	66	894806	67	886877	69	878678	71	870212	74
32	9720	64	2335	67	4875	69	6742	71	8539	73	0069	77
33	9599	66	2209	69	4645	71	6608	74	8400	76	899226	79
34	9478	68	2084	71	4415	73	6473	76	8261	78	8782	82
35	9357	70	1958	73	4284	75	6338	78	8122	81	8589	84
36	9236	72	1833	75	4154	78	6204	81	7983	84	8495	87
37	9115	74	1707	77	4024	80	6069	83	7844	86	8351	89
38	8994	76	1581	79	3894	82	5934	86	7704	89	8207	91
39	8873	78	1455	81	3763	84	5799	87	7565	91	8064	94
40	8751	80	1329	84	3633	86	5664	90	7425	93	7920	96
41	908630	82	901206	86	893502	89	885529	92	877286	95	868779	98
42	8608	84	1077	88	3871	91	5394	94	7148	97	8632	101
43	8367	86	0951	90	3241	93	5258	96	7006	100	8487	103
44	8265	88	0825	92	3110	95	5123	98	6867	102	8343	106
45	8143	90	0699	95	2979	97	4998	101	6727	105	8199	108
46	8021	92	0572	97	2848	100	4852	103	6587	107	8054	110
47	7900	94	0445	99	2717	102	4717	105	6447	109	7910	112
48	7778	96	0319	101	2586	104	4581	107	6307	112	7766	115
49	7656	98	0192	103	2455	106	4445	110	6167	114	7621	117
50	7533	100	0065	105	2323	108	4310	112	6028	117	7476	119
51	907411	102	899989	107	892192	111	884174	114	875886	119	867831	122
52	7289	104	9612	109	2061	113	4038	116	5746	122	7187	124
53	7167	106	9685	111	1929	115	3902	119	5605	124	7042	127
54	7044	109	9558	113	1798	117	3768	121	5465	126	6897	129
55	6922	111	9431	116	1668	119	3630	124	5324	129	6752	132
56	6799	113	9304	118	1534	122	3493	126	5183	131	6607	134
57	6676	115	9176	120	1402	124	3357	129	5042	133	6461	137
58	6554	117	9 49	122	1271	126	3221	131	4902	136	6316	139
59	6431	119	8922	124	1139	129	3084	133	4761	138	6171	142
60	6308	121	8794	127	1007	131	2948	136	4620	140	6025	144

TABLE XVI.—Nat. Cosines.

TABLE XVI.—Nat. Cosines.

°	30°		31°		32°		33°		34°		35°	
	Co-sine.	Parts for "	Co-sine.	Parts for "	Co-sine.	Parts for "	Co-sine.	Parts for "	Co-sine.	Parts for "	Co-sine.	Parts for "
0	866025	0	857187	0	848048	0	838671	0	829038	0	819152	0
1	5880	2	7017	3	7894	3	8612	3	8875	3	8945	3
2	5734	5	6868	5	7740	5	8854	5	8712	6	8819	6
3	5589	7	6718	8	7585	8	8195	8	8649	8	8651	9
4	5443	9	6567	10	7431	10	8036	11	8386	11	8481	11
5	5297	12	6417	13	7277	13	7878	13	8223	14	8317	14
6	5151	15	6267	15	7122	15	7719	15	8060	16	8150	17
7	5006	17	6117	17	6967	16	7560	19	7897	19	7982	20
8	4860	19	5966	20	6818	20	7401	22	7734	22	7815	23
9	4713	22	5816	22	6658	23	7242	24	7571	25	7648	25
10	4567	24	5666	25	6508	26	7083	27	7407	27	7480	28
11	864421	27	855515	27	846348	28	836924	29	827244	30	817818	31
12	4275	29	5364	30	6193	31	6764	32	7081	33	7145	34
13	4128	32	5214	32	6038	33	6606	35	6917	36	6977	36
14	3982	34	5063	35	5883	35	6446	38	6753	38	6809	39
15	3836	37	4912	38	5728	36	6286	40	6590	41	6642	42
16	3689	39	4761	40	5573	41	6127	43	6426	44	6474	44
17	3542	41	4610	43	5417	44	5967	46	6262	47	6306	47
18	3396	44	4459	45	5262	47	5807	48	6098	49	6138	50
19	3249	46	4308	47	5108	49	5648	51	5934	52	5970	53
20	3102	49	4156	50	4951	52	5488	54	5770	55	5801	56
21	863955	51	854005	52	844785	54	835328	53	825806	57	815833	58
22	2908	54	3854	55	4640	57	5168	59	5442	60	5465	61
23	2661	56	3702	57	4484	60	5008	62	5278	63	5296	64
24	2514	59	3551	60	4328	62	4849	65	5113	65	5128	67
25	2366	61	3399	62	4172	65	4688	67	4949	68	4959	70
26	2219	63	3248	65	4016	68	4527	70	4785	71	4791	73
27	2072	66	3096	67	3860	72	4367	72	4620	73	4622	76
28	1924	68	2944	70	3704	74	42 7	75	4456	76	4453	79
29	1777	71	2792	73	3548	76	4048	78	4291	79	4284	82
30	1629	74	2640	76	3391	78	3888	81	4126	82	4116	84
31	861482	77	852488	78	843285	81	833725	84	823961	84	813947	87
32	1334	80	2336	81	3079	84	3665	87	3797	87	3778	90
33	1186	82	2184	83	2922	87	3404	90	3632	90	3608	93
34	1038	84	2032	85	2766	90	3243	93	3467	93	3439	96
35	0890	87	1879	88	2609	92	3082	95	3302	96	3270	98
36	0742	89	1727	90	2452	94	2921	98	3136	99	3101	101
37	0594	92	1575	93	2296	97	2760	101	2971	102	2931	104
38	0446	94	1422	96	2139	99	2599	103	2806	105	2762	107
39	0298	97	1269	99	1982	102	2438	106	2641	108	2592	110
40	0149	99	1117	102	1825	105	2277	108	2475	111	2423	113
41	860001	102	850964	106	841068	108	832115	111	822310	114	812258	115
42	859852	108	0811	107	1511	111	1954	114	2144	116	2084	118
43	9704	106	0658	109	1354	113	1793	116	1978	119	1914	121
44	9555	109	0505	111	1198	115	1631	119	1813	122	1744	124
45	9406	112	0352	114	1039	113	1470	121	1647	125	1574	127
46	9258	114	0199	117	0882	121	1308	124	1481	128	1404	130
47	9109	116	0046	119	0724	123	1146	127	1315	131	1234	133
48	8960	118	849893	122	0567	126	0984	129	1149	134	1064	136
49	8811	121	9739	125	0409	128	0823	132	0983	136	0894	139
50	8662	124	9586	128	0251	131	0661	135	0817	139	0723	142
51	868518	126	849433	131	840094	134	830499	138	820651	142	810553	144
52	8664	129	9279	133	839936	136	0337	141	0485	145	0363	147
53	8214	131	9125	135	9778	139	0174	143	0814	147	0212	150
54	8065	134	8972	138	9620	142	0012	146	0152	150	0042	153
55	7916	136	8818	140	9462	144	829850	148	819985	153	808871	156
56	7768	139	8664	143	9 01	147	9688	151	9819	156	9700	159
57	7618	142	8510	145	9146	150	9525	154	9652	158	9530	162
58	7467	145	8356	148	8987	152	9363	158	9486	161	9359	164
59	7317	147	8202	151	8829	155	9200	159	9319	164	9188	167
60	7167	149	8048	153	8671	157	9038	162	9152	166	9017	170

TABLE XVI.—Nat. Cosines.

TABLE XVI.—Nat. Cosines.

°	36°		37°		38°		39°		40°		41°	
	Co-sine.	Parts for "	Co-sine.	Parts for "	Co-sine.	Parts for "	Co-sine.	Parts for "	Co-sine.	Parts for "	Co-sine.	Parts for "
0	809017	0	798636	0	788011	0	777146	0	766744	0	754710	0
1	8846	3	8460	3	7832	3	6963	3	5857	3	4519	3
2	8675	6	8285	6	7652	6	6780	6	5670	6	4328	6
3	8504	9	8110	9	7473	9	6596	9	5483	9	4137	10
4	8333	11	7935	12	7294	12	6413	12	5296	13	3946	13
5	8161	14	7759	15	7114	15	6230	15	5109	16	3755	16
6	7990	17	7584	18	6935	18	6048	18	4921	19	3563	19
7	7819	20	7408	20	6756	21	5863	21	4734	22	3372	22
8	7647	23	7233	23	6576	24	5679	24	4547	25	3181	25
9	7475	26	7057	26	6396	27	5496	27	4359	28	2989	28
10	7304	29	6882	29	6217	30	5312	31	4171	31	2798	32
11	807132	32	796706	32	786037	33	775128	34	763984	34	752606	35
12	6960	34	6530	35	5857	36	4945	37	3796	38	2415	38
13	6789	37	6354	38	5677	39	4761	40	3608	41	2223	41
14	6617	40	6178	41	5497	42	4577	43	3420	44	2032	44
15	6445	43	6002	44	5317	45	4393	46	3232	47	1840	48
16	6273	46	5826	47	5137	48	4209	49	3044	50	1648	51
17	6101	49	5650	50	4957	51	4024	52	2856	53	1456	54
18	5928	52	5473	53	4776	54	3840	55	2668	57	1264	57
19	5756	55	5297	56	4596	57	3656	58	2480	60	1072	60
20	5584	57	5121	59	4416	60	3472	61	2292	63	880	64
21	805411	60	794944	62	784235	63	773287	65	762104	66	750688	67
22	5239	63	4768	65	4056	66	3103	68	1915	69	0496	70
23	5066	66	4591	68	3874	69	2918	71	1727	72	0303	73
24	4894	69	4415	71	3694	72	2734	74	1538	75	0111	86
25	4721	72	4238	74	3513	75	2549	77	1350	78	74919	80
26	4548	75	4061	76	3332	78	2364	80	1161	82	9726	83
27	4376	78	3884	79	3151	81	2179	83	972	85	9534	86
28	4203	81	3707	82	2970	84	1995	86	0784	88	9341	89
29	4030	84	3530	85	2789	87	1810	89	0595	91	9148	92
30	3857	86	3353	88	2608	90	1625	92	0406	94	8956	96
31	803684	89	793174	92	782427	94	771440	97	760217	98	748763	101
32	3511	92	2999	95	2246	97	1254	100	0628	101	8570	104
33	3338	95	2822	98	2065	100	1069	103	759389	105	8377	107
34	3164	98	2644	101	1883	103	0884	106	9650	108	8184	110
35	2991	101	2467	104	1702	106	0699	109	9461	111	7991	113
36	2818	104	2290	107	1520	109	0513	112	9271	114	7798	117
37	2644	107	2112	110	1339	112	0328	115	9082	117	7605	120
38	2471	110	1935	113	1157	115	0142	118	8893	120	7412	123
39	2297	113	1757	116	0976	118	769657	121	8703	123	7218	126
40	2123	116	1579	119	0794	121	9771	124	8514	127	7025	129
41	801950	118	791401	121	780112	125	769585	127	758324	130	746832	133
42	1776	121	1224	124	0430	128	9400	130	8134	133	6658	136
43	1602	124	1046	127	0249	131	9214	133	7945	136	6445	139
44	1428	127	0868	130	0067	134	9028	136	7755	139	6251	142
45	1254	130	0690	133	779824	137	8842	139	7565	142	6057	145
46	1080	133	0512	136	9702	140	8656	143	7375	145	5864	149
47	0906	136	0333	139	9520	143	8470	146	7185	149	5670	152
48	0731	139	0155	142	9338	146	8284	149	6995	152	5476	155
49	0557	142	78977	145	9156	149	8097	152	6805	155	5282	159
50	0383	145	9798	148	8973	152	7911	155	6615	158	5088	162
51	800278	147	789620	151	778791	155	767725	158	756425	161	744894	166
52	0034	150	9441	154	8608	158	7538	161	6234	165	4700	169
	799839	153	9263	157	8426	161	7352	164	6044	168	4506	172
	9923	156	9084	160	8243	164	7165	167	5854	171	4312	175
	9510	159	8905	163	8060	167	6979	171	5663	174	4117	178
	9335	162	8727	166	7878	170	6792	174	5472	177	3923	181
	9160	165	8548	169	7695	173	6605	177	5282	180	3728	184
	8985	168	8369	172	7512	176	6418	180	5091	184	3534	188
	8811	171	8190	175	7329	179	6231	183	4900	187	3339	191
	8636	174	8011	178	7146	182	6044	186	4710	190	3145	194

TABLE XVI.—Nat. Cosines.

TABLE XVI.—Nat. Cosines.

°	42°		43°		44°		45°		46°		47°	
	Co-sine.	Parts for "	Co-sine.	Parts for "	Co-sine.	Parts for "	Co-sine.	Parts for "	Co-sine.	Parts for "	Co-sine.	Parts for "
0	743145	0	731354	0	719340	0	707107	0	694658	0	681998	0
1	2950	3	1155	3	9138	3	6901	3	4449	3	1786	4
2	2755	7	0957	7	8936	7	6695	7	4240	7	1573	7
3	2561	10	0758	10	8733	10	6489	10	4030	11	1360	10
4	2366	13	0560	13	8531	14	6284	14	3821	14	1147	14
5	2171	17	0361	16	8329	17	6078	17	3611	18	0934	18
6	1976	20	0162	20	8126	20	5872	21	3402	21	0721	21
7	1781	23	729963	23	7924	24	5666	24	3192	25	0508	25
8	1586	26	9765	26	7721	27	5459	23	2983	28	0295	23
9	1391	29	9666	29	7519	31	5253	31	2773	32	0081	32
10	1195	33	9367	33	7316	34	5047	34	2563	35	679668	36
11	741000	36	729168	36	717118	38	704841	38	692358	39	679655	39
12	0805	39	8969	39	6911	41	4634	41	2143	42	9441	43
13	0609	42	8770	42	6708	45	4428	45	1933	46	9229	46
14	0414	46	8570	46	6505	48	4221	48	1723	49	9014	50
15	0218	49	8371	50	6302	51	4015	52	1513	52	8801	53
16	0023	52	8172	53	6099	55	3808	55	1303	56	8587	57
17	739327	55	7972	56	5896	58	3601	59	1093	59	8378	60
18	9631	58	7773	60	5693	62	3395	62	0882	63	8160	64
19	9435	62	7573	63	5490	66	3188	66	0676	66	7946	67
20	9239	65	7374	66	5286	68	2981	69	0462	70	7732	71
21	739043	68	727174	70	715063	72	702774	73	690251	73	677518	74
22	8848	71	6974	73	4890	75	2567	76	0441	77	7304	78
23	8651	75	6775	76	4678	79	2360	80	689890	80	7090	81
24	8455	78	6575	80	4473	82	2153	83	9620	84	6876	85
25	8259	81	6375	83	4268	85	1946	86	9409	87	6662	89
26	8063	84	6175	86	4066	88	1739	90	9198	91	6449	92
27	7867	88	5975	90	3862	92	1531	93	8987	94	6233	96
28	7670	91	5775	93	3658	96	1324	97	8776	98	6019	99
29	7474	94	5575	96	3454	99	1117	100	8568	101	5805	103
30	7277	98	5374	100	3250	102	0909	103	8355	105	5590	107
31	737061	103	725174	104	713047	106	700702	107	688144	110	675376	111
32	6284	106	4974	107	2843	109	0494	111	7932	113	5161	115
33	6087	110	4773	110	2639	112	0287	114	7721	117	4947	118
34	6491	113	4573	113	2434	116	0079	118	7510	120	4732	122
35	6294	116	4372	117	2230	119	699671	121	7299	124	4517	125
36	6097	119	4172	120	2026	123	9663	125	7088	127	4302	129
37	5900	123	3971	123	1822	126	9455	128	6876	131	4088	133
38	5703	126	3771	127	1617	130	9248	132	6665	134	3873	136
39	5506	129	3570	130	1413	133	9040	135	6453	138	3658	140
40	5309	132	3369	134	1209	137	8832	139	6242	141	3443	143
41	735112	135	723168	137	711004	140	698622	142	686080	144	673228	147
42	4915	139	2967	141	0799	143	8415	145	5818	148	3013	151
43	4717	142	2766	144	0695	146	8207	149	5607	152	2797	154
44	4520	145	2565	147	0590	150	7999	152	5395	156	2582	158
45	4323	149	2364	150	0185	153	7790	156	5183	159	2367	161
46	4125	152	2163	154	709981	157	7582	159	4971	163	2151	165
47	3927	155	1962	157	9776	160	7374	163	4759	167	1936	169
48	3730	158	1760	161	9671	164	7165	166	4547	170	1721	172
49	3532	162	1559	164	9366	167	6957	170	4336	174	1505	176
50	3334	166	1357	168	9161	171	6748	173	4123	177	1290	179
51	733187	169	721156	171	708956	174	696589	177	683911	181	671074	183
52	2939	172	0954	174	8750	177	6380	180	3698	184	0858	186
53	2741	175	0753	177	8545	181	6122	184	3488	188	0642	190
54	2543	178	0551	181	8340	184	5913	187	3274	191	0427	193
55	2345	182	0349	184	8135	188	5704	191	3061	195	0211	197
56	2147	185	0148	188	7929	191	5495	194	2849	198	669995	201
57	1949	188	719946	191	7724	195	5286	198	2636	202	9779	204
58	1750	191	9744	194	7518	198	5077	201	2424	205	9563	206
59	1552	194	9542	197	7312	202	4868	205	2211	209	9347	211
60	1354	197	9340	201	7107	205	4658	208	1998	212	9131	214

TABLE XVI.—Nat. Cosines.

TABLE XVI.—Nat. Cosines.

°	48°		49°		50°		51°		52°		53°	
	Co-sine.	Parts for "	Co-sine.	Parts for "	Co-sine.	Parts for "	Co-sine.	Parts for "	Co-sine.	Parts for "	Co-sine.	Parts for "
0	669131	0	650669	0	642798	0	629320	0	615661	0	601815	0
1	8914	4	5640	4	2565	4	9094	4	5432	4	1583	4
2	8898	7	5620	7	2342	8	8868	8	5203	8	1350	8
3	8482	11	5400	11	2119	11	8642	11	4974	12	1118	12
4	8265	14	5180	15	1896	15	8418	15	4744	16	8855	16
5	8049	18	4961	19	1673	19	8189	19	4515	19	6653	19
6	7833	22	4741	22	1450	22	7963	23	4285	23	4420	23
7	7616	25	4521	26	1226	26	7737	26	4056	27	0189	27
8	7399	29	4301	30	1003	30	7510	30	3823	31	599355	31
9	7183	32	4081	33	0780	34	7284	34	3593	35	9722	35
10	6968	36	3861	37	0557	37	7057	38	3367	38	9469	39
11	666749	39	358641	41	340333	41	626830	42	313137	42	599256	43
12	6532	43	3421	44	0110	45	6804	45	2907	46	9024	47
13	6316	46	3200	48	639896	49	6877	49	2677	50	8791	50
14	6099	50	2930	52	9363	53	6150	53	2447	54	8558	54
15	5882	54	2760	55	9439	56	5923	57	2217	57	8325	58
16	5665	57	2539	59	9215	60	5697	61	1937	61	8092	62
17	5448	61	2319	63	8993	64	5470	64	1757	65	7858	66
18	5230	64	2098	66	8768	68	5243	68	1527	69	7625	70
19	5013	68	1878	70	8544	72	5016	72	1297	73	7392	74
20	4796	72	1657	73	8320	75	4789	76	1067	77	7159	78
21	664579	75	351437	77	639096	78	624561	80	610836	81	596925	82
22	4361	79	1216	81	7872	82	4334	84	0806	85	6892	86
23	4144	82	0995	85	7648	86	4107	88	0378	89	6458	90
24	3928	86	0774	89	7424	90	3880	92	0145	92	6225	94
25	3709	90	0553	93	7200	94	3652	95	609915	96	5991	98
26	3491	93	0332	96	6976	97	3425	99	9684	100	5758	102
27	3273	97	0111	100	6751	101	3197	103	9454	104	5524	106
28	3056	101	649890	103	6527	105	2970	107	9223	108	5290	110
29	2838	105	9669	107	6303	109	2742	111	8992	111	5057	114
30	2620	109	9448	110	6078	112	2515	114	8761	115	4823	117
31	662402	114	649227	115	635654	117	622237	119	608631	119	594589	121
32	2184	118	9006	118	5629	121	2059	123	8300	123	4355	125
33	1968	121	8784	122	5405	124	1831	127	8069	127	4121	129
34	1748	125	8563	126	5180	128	1604	131	7839	131	3887	133
35	1530	128	8341	129	4955	131	1376	134	7607	135	3653	137
36	1312	132	8120	133	4731	134	1148	138	7376	139	3419	141
37	1094	135	7898	137	4506	138	0920	142	7145	143	3185	145
38	0875	139	7677	141	4281	142	0692	146	6914	147	2951	149
39	0657	143	7455	144	4056	146	0464	150	6682	151	2718	153
40	0439	146	7233	148	3831	150	0235	153	6451	154	2482	156
41	660220	150	647012	152	633806	158	620007	157	606220	158	592248	160
42	0002	154	6790	155	3881	157	619779	161	5938	162	2013	164
43	669783	157	6666	159	3156	161	9551	165	5757	166	1779	168
44	9565	161	6346	163	2931	165	9322	169	5526	170	1544	172
45	9346	164	6124	167	2705	169	9094	172	5294	174	1310	176
46	9127	168	5902	171	2480	172	8865	176	5062	178	1075	180
47	8908	172	5680	174	2255	176	8637	180	4831	182	0840	184
48	8690	175	5458	178	2029	180	8408	184	4609	186	0606	188
49	8471	179	5236	181	1804	183	8180	188	4387	190	0371	192
50	8252	183	5013	185	1578	187	7951	191	4156	194	0136	195
51	658733	187	644791	188	631353	191	617722	195	603904	197	589901	199
52	7814	190	4569	192	1127	195	7494	199	8672	201	9656	208
53	7594	194	4346	196	0902	199	7265	203	3440	206	9431	207
54	7373	197	4124	200	0678	202	7036	206	3208	209	9196	211
55	7156	201	3901	204	0150	206	6807	210	2976	213	8961	215
56	6937	204	3679	207	0224	210	6578	214	2744	217	8726	219
57	6717	208	3456	211	629998	214	6349	218	2512	220	8491	223
58	6496	212	3233	215	9772	218	6120	221	2280	224	8256	227
59	6279	215	3010	218	9546	221	5891	225	2047	228	8021	231
60	6059	219	2788	222	9320	225	5661	228	1815	231	7785	234

TABLE XVI.—Nat. Cosines.

TABLE XVI.—Nat. Coeffines.

°	54°		55°		56°		57°		58°		59°	
	Co-sine.	Parts for "	Co-sine.	Parts for "	Co-sine.	Parts for "	Co-sine.	Parts for "	Co-sine.	Parts for "	Co-sine.	Parts for "
0	587785	0	573578	0	559193	0	544639	0	529919	0	515088	0
1	7550	4	3338	4	8952	4	4395	4	9673	4	4789	4
2	7315	8	3100	8	8710	8	4151	8	9426	8	4539	8
3	7079	12	2861	12	8469	12	3907	12	9179	12	4290	12
4	6844	16	2623	16	8228	16	3663	16	8932	17	4040	17
5	6608	20	2384	20	7987	20	3419	20	8685	21	3791	21
6	6372	24	2146	24	7745	24	3174	24	8438	25	3541	25
7	6137	28	1907	28	7504	28	2930	28	8191	29	3292	29
8	5901	32	1669	32	7262	32	2686	32	7944	33	3042	33
9	5665	36	1430	36	7021	36	2442	37	7697	37	2792	37
10	5429	39	1191	40	6779	40	2197	41	7450	41	2543	42
11	585194	43	570952	44	556637	45	541953	45	527203	45	512293	46
12	4958	47	0714	48	8296	49	1708	49	6956	49	2043	50
13	4722	51	0475	52	8054	53	1464	53	6709	54	1793	54
14	4486	55	0236	56	6812	57	1219	57	6461	58	1543	58
15	4250	59	569997	60	6570	61	0975	61	6214	62	1293	62
16	4014	63	9758	64	6328	65	0730	65	5967	66	1043	67
17	3777	67	9519	68	5086	69	0485	69	5719	70	793	71
18	3541	71	9281	72	4844	73	0240	73	5472	74	0543	75
19	3306	75	9040	76	4602	77	539996	77	5224	78	0293	79
20	3069	79	8801	80	4360	81	9751	81	4977	82	0043	83
21	582832	83	568682	84	554118	85	539506	86	524729	87	509792	87
22	2596	87	8323	88	3676	89	9261	90	4481	91	9542	91
23	2*60	91	5083	92	3634	93	9016	94	4234	95	9292	95
24	2123	95	7844	96	3392	97	8771	98	3968	99	9041	99
25	1896	99	7604	100	3149	101	8528	102	3738	103	8791	104
26	1650	103	7365	104	2907	105	8281	106	3490	107	8541	108
27	1413	107	7126	108	2664	109	8035	110	3242	111	8290	112
28	1176	111	6888	112	2422	113	7790	114	2995	115	8040	117
29	0940	115	6646	116	2180	117	7545	118	2747	119	7789	121
30	0703	118	6406	120	1937	122	7300	122	2499	124	7538	126
31	580466	122	568166	124	551694	126	537054	127	522251	128	507288	130
32	0229	126	6297	128	1452	130	6809	131	2002	132	7037	134
33	579992	130	5687	132	1209	134	6663	135	1754	136	6786	138
34	9755	134	5447	136	0966	138	6318	139	1506	141	6536	142
35	9518	138	5207	140	0724	142	6072	143	1258	145	6286	146
36	9281	142	4967	144	0481	146	5*27	148	1010	149	6034	151
37	9044	146	4727	148	0238	150	5591	152	0761	153	5783	155
38	8807	150	4487	152	549995	154	5336	156	0513	158	5532	159
39	8570	154	4247	156	9752	158	5090	160	0265	162	5281	163
40	8332	158	4007	160	9509	162	4844	164	0016	166	5030	168
41	578096	162	563766	164	549266	166	534598	168	519768	170	504779	172
42	7858	166	3526	168	9023	171	4352	172	9519	174	4528	176
43	7620	170	3286	172	8780	175	4107	176	9271	178	4277	180
44	7383	174	3045	176	8536	179	3861	180	9022	182	4025	184
45	7145	178	2805	180	8293	183	3615	184	8773	186	3774	188
46	6908	182	2564	184	8050	187	3369	189	8525	190	3523	193
47	6670	186	2324	188	7807	191	3122	193	8276	195	3271	197
48	6432	190	2083	192	7563	195	2876	197	8027	199	3020	201
49	6195	194	1843	196	7320	199	2630	201	7778	203	2769	205
50	5957	198	1602	200	7076	203	2384	205	7529	207	2517	210
51	575719	202	561361	204	546833	207	53213~	209	517280	212	502266	214
52	5481	206	1121	208	6589	211	1891	213	7031	216	2014	218
53	5243	210	0680	212	6346	215	1645	217	6*82	220	1762	222
54	5005	214	0639	216	6102	219	1399	221	6533	224	1511	226
55	4767	218	0398	220	5858	223	1152	226	6284	228	1259	230
56	4529	222	0157	224	5615	227	0906	230	6035	233	1007	235
57	4291	226	569916	228	5371	231	0659	234	5784	237	0756	239
58	4053	230	9675	232	5127	235	0413	238	5537	241	0504	243
59	3815	234	9434	236	4883	239	0166	242	5287	245	0252	247
60	3578	237	9193	240	4639	243	529919	246	5038	249	0001	251

TABLE XVI.—Nat. Coeffines.

TABLE XVI.—Nat. Cosines.

°	60°		61°		62°		63°		64°		65°	
	Co-sine.	Parts for "	Co-sine.	Parts for "	Co-sine.	Parts for "	Co-sine.	Parts for "	Co-sine.	Parts for "	Co-sine.	Parts for "
0	50000	0	484810	0	469472	0	453991	0	438371	0	422618	0
1	499748	4	4555	4	9215	4	8731	4	8110	4	2555	4
2	9494	8	4301	8	8958	8	8472	8	7848	8	2091	8
3	9244	12	4048	13	8701	13	8218	13	7587	13	1827	13
4	8992	17	3792	17	8444	17	2954	17	7325	17	1563	18
5	8740	21	3537	21	8187	21	2694	22	7068	22	13	0
6	8488	25	3282	25	7930	26	2435	26	6802	26	1036	26
7	8236	30	3028	30	7673	30	2175	30	6540	31	0772	31
8	7983	34	2773	34	7416	34	1916	35	6278	35	0508	35
9	7731	38	2518	38	7156	38	1656	39	6017	39	0244	40
10	7479	42	2263	43	6901	43	1397	43	5756	44	41980	44
11	497226	46	482009	47	466644	47	451187	48	435493	48	419716	48
12	6974	50	1754	51	6387	51	0878	52	5231	52	9452	53
13	6722	54	1499	55	6129	55	0618	56	4969	57	9188	57
14	6469	58	1244	59	5872	60	0358	61	4707	61	8924	62
15	6217	63	0989	63	5615	64	0098	65	4445	66	8660	66
16	5964	67	0734	67	5357	68	449839	69	4183	70	8396	71
17	5711	71	0479	72	5100	72	9679	74	3921	74	8131	75
18	5459	75	0224	76	4842	77	9319	78	3659	79	7867	79
19	5206	79	479968	80	4585	81	9059	82	3397	83	7603	84
20	4953	84	9718	85	4327	85	8799	87	3135	87	7339	88
21	494701	88	479458	89	464069	90	448539	91	432873	92	417074	92
22	4448	92	9208	93	3812	94	8279	95	2610	96	6810	97
23	4195	96	8947	97	3554	98	8019	100	2348	100	6545	101
24	3942	100	8692	101	3296	103	7759	104	2086	105	6281	106
25	3689	105	8436	106	3038	107	7499	108	1823	109	6016	110
26	3436	109	8181	110	2780	111	7239	113	1561	113	5752	114
27	3183	113	7926	115	2523	115	6979	117	1299	118	5487	119
28	2930	117	7670	119	2265	120	6718	121	1036	122	5223	123
29	2677	121	7414	123	2007	124	6456	126	0774	126	4958	128
30	2424	126	7159	128	1749	129	6196	130	0511	131	4698	132
31	492170	131	476903	132	461491	133	445936	134	430249	136	414429	137
32	1917	135	6647	136	1233	138	5677	139	429996	140	4164	141
33	1664	140	6392	141	0974	142	5417	143	9723	145	3899	146
34	1411	144	6136	145	0716	146	5156	147	9461	149	3634	150
35	1157	148	5880	149	0458	151	4896	152	9193	153	3369	154
36	0904	152	5624	154	0200	155	4635	156	8935	158	3104	159
37	0650	156	5368	158	459942	159	4375	160	8672	162	2840	163
38	0397	161	5112	162	9633	164	4114	165	8410	167	2575	168
39	0143	165	4856	166	9425	168	3853	169	8147	171	2310	172
40	489890	169	4600	171	9167	172	3593	174	7894	175	2045	177
41	489636	173	474344	175	458906	177	443332	178	427621	180	411780	181
42	9393	178	4086	179	8650	181	3071	182	7358	184	1514	185
43	9129	182	3832	183	8391	185	2810	187	7095	189	1249	189
44	8875	186	3576	187	8133	189	2550	191	6832	193	0984	194
45	8621	190	3320	192	7874	194	2289	195	6569	197	0719	199
46	8367	195	3063	196	7615	198	2029	199	6306	202	0454	203
47	8114	199	2807	200	7357	202	1767	204	6043	206	0188	207
48	7860	203	2551	204	7098	207	1506	208	5779	210	409923	212
49	7606	207	2294	208	6839	211	1245	212	5516	215	6658	216
50	7352	212	2038	213	6580	215	0984	217	5253	219	9392	221
51	487098	216	471782	217	456322	220	440723	221	424990	224	409127	225
52	6844	220	1625	221	6063	224	0462	226	4726	228	8962	230
53	6590	224	1269	225	5804	228	0200	230	4463	232	8596	234
54	6337	229	1012	230	5545	233	439939	234	4199	237	8331	239
55	6081	233	6755	234	5286	237	9678	239	3936	241	8065	243
56	5827	237	0499	238	5027	241	9417	243	3673	245	7799	247
57	5573	241	0242	242	4768	246	9155	247	3409	250	7534	252
58	5318	245	469985	247	4509	250	8894	251	3146	254	7268	256
59	5064	249	9728	251	4250	254	8633	256	2882	259	7002	260
60	4810	254	9472	256	3991	258	8371	260	2618	263	6737	265

TABLE XVI.—Nat. Cosines.

TABLE XVI.—Nat. Cosines.

°	66°		67°		68°		69°		70°		71°	
	Co-sine.	Parts for "	Co-sine.	Parts for "	Co-sine.	Parts for "	Co-sine.	Parts for "	Co-sine.	Parts for "	Co-sine.	Parts for "
0	408737	0	390731	0	374607	0	359368	0	342020	0	325588	0
1	6471	4	0469	4	4337	5	8096	5	1747	5	5293	5
2	6205	9	0196	9	4067	9	7825	9	1473	9	5018	9
3	5919	13	189923	13	3797	14	7553	14	1200	14	4743	14
4	5673	18	9 160	18	3526	18	7281	18	0927	18	4468	18
5	5408	22	9392	22	32 8	22	7010	22	0653	22	4193	22
6	5142	27	9124	27	2989	27	6738	27	0389	27	3917	27
7	4878	31	8858	31	2715	31	6466	31	0106	31	3642	31
8	4610	36	8588	36	2448	36	6194	36	339333	36	3367	36
9	4344	40	8320	40	2178	41	5923	41	9559	41	3092	41
10	4078	44	8052	45	1903	45	5651	46	9285	46	2816	46
11	408811	49	387781	49	371638	50	355379	50	338012	50	322541	51
12	3545	53	7516	54	1363	54	5107	54	3738	55	2266	55
13	3278	58	7247	58	1098	59	4935	59	3464	59	1990	60
14	3013	62	6979	63	0828	63	4563	63	3191	64	1715	64
15	2747	66	6711	67	657	65	4291	68	2917	68	1440	69
16	2480	71	6443	72	0287	72	4019	73	2643	73	1164	74
17	2214	76	6174	76	0017	77	3747	77	2369	78	0889	78
18	1948	80	5906	81	369747	81	3476	82	2095	82	6113	82
19	1681	85	5638	85	9477	86	3203	87	1821	87	0837	87
20	1415	89	5369	89	9216	90	2931	91	1548	91	0062	92
21	401149	94	385101	93	368938	95	352658	96	336274	96	319786	96
22	0682	98	4832	98	6665	100	2386	100	6000	100	9511	101
23	0616	103	4564	102	8395	104	2114	105	5726	105	9235	106
24	0349	107	4295	107	8125	108	1842	109	5452	109	8969	110
25	0083	112	4027	111	7854	118	1569	114	5178	114	8684	115
26	399816	116	3758	116	7584	117	1297	118	4908	118	8402	119
27	9549	121	3490	121	7313	123	1025	128	4629	123	8132	124
28	9283	125	3221	125	7043	126	0752	127	4355	127	7856	128
29	9018	129	2952	130	6772	131	0480	132	4081	132	7581	132
30	8749	133	2683	134	6501	135	0207	136	3807	137	7305	138
31	398482	138	392415	139	366231	140	349935	141	333533	142	317029	143
32	8216	142	2145	143	6960	144	9662	145	3258	146	6753	147
33	7949	147	1877	148	5689	149	9390	150	2984	151	6477	152
34	7692	151	1608	152	5418	153	9117	155	2710	155	6201	157
35	7415	156	1339	157	5148	158	8845	159	2436	160	5925	161
36	7148	160	1070	161	4877	162	8572	164	2161	165	5649	166
37	6881	165	0801	166	46 6	167	8299	168	1887	169	5373	171
38	6614	169	0532	170	4385	171	8027	173	1612	173	5097	175
39	6347	174	02 3	175	4064	176	7754	177	1338	178	4821	180
40	6080	178	379994	179	3793	180	7481	182	1063	183	4545	184
41	395813	182	379725	184	368522	185	347209	186	330789	187	314269	189
42	5546	187	04 6	188	3251	189	6986	191	0514	192	3993	193
43	5278	191	9187	193	2980	194	6663	195	0249	197	3716	198
44	5011	196	8918	197	2709	198	6390	200	329965	201	3440	202
45	4744	200	8649	202	2438	203	6117	205	9691	206	3164	207
46	4477	205	8379	206	2167	207	5844	209	9416	210	2888	212
47	4209	209	8110	211	1896	212	5571	214	9141	215	2611	216
48	3942	214	7841	215	1625	216	5298	218	8867	220	2335	221
49	3675	218	7571	220	1353	221	5025	223	8592	224	2059	225
50	3407	223	7302	224	1082	226	4752	228	8317	229	1782	230
51	398140	227	377083	229	360811	230	344479	232	338042	234	311506	235
52	2872	231	6763	233	0540	235	4206	237	7768	238	1229	239
53	2605	236	6494	238	0268	239	3933	241	7493	243	0953	244
54	2337	240	6224	242	369997	244	3660	246	7218	247	0676	248
55	2070	245	5955	247	9725	248	3387	250	6943	252	0400	253
56	1802	249	5685	251	9454	253	3113	255	6668	256	0123	256
57	1534	254	5416	256	9183	257	2840	259	6393	261	308647	262
58	1267	258	5146	260	8911	262	2567	264	6118	265	9570	267
59	0999	263	4876	265	8640	266	2294	268	5843	270	9294	271
60	0731	267	4607	269	8368	271	2020	273	5568	274	9017	276

TABLE XVI.—Nat. Cosines.

TABLE XVI.—Nat. Cosines.

#	72°		73°		74°		75°		76°		77°	
	Cosine.	Parts for "	Cosine.	Parts for "	Cosine.	Parts for "	Cosine.	Parts for "	Cosine.	Parts for "	Cosine.	Parts for "
0	39017	0	292372	0	275637	0	258819	0	241922	0	224951	0
1	8740	5	2094	5	5368	5	8398	5	1640	5	4668	5
2	8464	9	1815	9	5078	9	8257	9	1357	9	4381	9
3	8187	14	1537	14	4795	14	7976	14	1075	14	4101	14
4	7910	18	1259	19	4519	19	7654	19	0793	19	3817	19
5	7633	23	0981	23	4239	23	7414	23	0510	24	3534	24
6	7357	28	0702	28	3959	28	7133	28	0228	28	3250	28
7	7080	32	0424	32	3779	33	6852	33	23946	33	2967	33
8	6803	37	0146	37	3400	37	6571	37	9663	38	2683	38
9	6526	42	28967	42	3120	42	6294	42	9881	43	2399	43
10	6249	46	9589	46	2840	47	6008	47	9098	47	2116	47
11	5972	51	28910	51	272560	51	255727	52	238810	52	221832	52
12	5695	55	9032	56	2290	56	5446	56	8334	57	1549	57
13	5418	60	8753	60	2000	61	5165	61	8251	61	1265	62
14	5141	65	8475	65	1720	65	4883	66	7908	66	0981	66
15	4864	69	8196	70	1440	70	4602	70	7686	71	0697	71
16	4587	74	7918	74	1161	75	4321	75	7403	75	0414	76
17	4310	78	7639	79	0881	79	4039	80	7121	80	0130	81
18	4033	83	7361	84	0600	84	3758	84	6838	85	219846	85
19	3756	88	7082	88	0320	89	3477	89	6556	90	9562	90
20	3479	92	6803	93	0040	93	3195	94	6273	94	9279	96
21	3202	97	286525	98	269760	98	252914	98	235990	99	218990	100
22	2924	102	9246	102	9480	103	2832	103	5708	104	8711	104
23	2647	106	6967	107	9200	107	2351	108	5125	110	8427	109
24	2370	111	5688	112	6920	112	2069	113	5142	113	8143	114
25	2093	116	5410	116	8640	117	1788	117	4559	118	7859	119
26	1815	121	5131	121	8359	121	1508	122	4577	122	7575	123
27	1538	126	4852	126	8079	126	1225	127	4294	127	7292	128
28	1261	130	4573	130	7799	131	0943	131	4111	131	7008	133
29	0983	134	4294	135	7519	135	0662	136	3728	137	6724	138
30	0706	139	4015	139	7238	140	0380	141	3445	141	6440	142
31	500428	143	283736	144	266858	145	250098	146	233163	146	216156	147
32	0151	148	3459	149	6678	150	249317	150	2280	151	572	152
33	299873	153	3179	154	6397	154	9535	155	2697	156	5688	157
34	9596	157	2900	158	6117	159	9253	160	2314	161	5304	161
35	9318	162	2621	163	5837	164	8972	165	2-31	165	5019	166
36	9041	167	2342	163	5556	163	8690	169	1748	170	4735	171
37	8763	171	2062	172	5276	173	8408	174	1465	175	4451	176
38	8485	176	1783	177	4995	178	8126	179	1182	179	4167	180
39	8208	181	1504	182	4715	183	7845	183	0899	184	3883	185
40	7930	185	1225	186	4434	187	7563	188	0616	189	3599	190
41	297653	190	280946	191	264154	192	247281	193	230333	194	213315	195
42	7375	195	4667	196	3873	197	6909	198	0650	198	9090	199
43	7097	199	0388	200	3593	201	6717	202	229767	203	2746	204
44	6819	204	0108	205	3312	206	6435	207	9184	208	2462	209
45	6542	208	279829	210	3031	211	6153	212	9200	213	2174	213
46	6264	213	9530	214	2751	215	5871	216	8917	217	1893	218
47	5986	218	9270	219	2470	220	5589	221	8634	222	1609	223
48	5708	222	8991	224	2189	225	5307	225	8351	227	1325	228
49	5430	227	8712	228	1909	230	5025	230	8068	232	1040	232
50	5152	231	8432	233	1628	234	4743	235	7784	236	0756	237
51	294874	236	278153	238	261347	239	244461	240	227501	241	210472	242
52	4598	241	7674	242	1050	244	4179	245	7218	246	0057	247
53	4318	245	7394	247	0765	248	3897	249	6935	250	209093	251
54	4040	250	7115	252	0505	253	3615	254	6651	255	9619	256
55	3762	254	7035	256	0224	258	3333	259	6368	260	9334	261
56	3484	259	6756	261	259943	262	3051	263	6085	265	9050	266
57	3206	264	6476	266	9662	267	2769	268	5801	269	8765	270
58	2928	268	6197	270	9381	272	2488	273	5518	274	8481	275
59	2650	273	5917	275	9100	276	2204	277	5235	279	8196	280
60	2372	277	5637	279	8819	281	1922	282	4951	283	7912	284

TABLE XVI.—Nat. Cosines.

TABLE XVI.—Nat. Cosines.

°	78°		79°		80°		81°		82°		83°	
	Co-sine	Parts for "	Co-sine	Parts for "	Co-sine	Parts for "	Co-sine	Parts for "	Co-sine	Parts for "	Co-sine	Parts for "
0	907912	0	190809	0	178648	0	158485	0	139173	0	121869	0
1	7827	5	0623	5	8362	5	6147	5	8885	5	1581	5
2	7343	9	0238	9	3075	10	5880	10	6597	10	1292	10
3	7058	14	189952	14	2789	14	5373	14	6309	14	1003	14
4	6773	19	9667	19	2502	19	5285	19	8021	19	0714	19
5	6489	24	9381	24	2216	24	4998	24	7733	24	0425	24
6	6204	28	9095	29	1929	29	4710	29	7445	29	0137	29
7	5920	33	8810	33	1643	33	4423	33	7156	34	119649	34
8	5635	38	8524	38	1356	38	4136	38	6868	38	9559	38
9	5350	43	8239	43	1069	43	3848	43	6581	43	9270	43
10	5066	47	7953	48	0783	48	3561	48	6292	48	8982	48
11	204781	52	187667	52	170496	52	153273	53	136004	53	118693	53
12	4496	57	7361	57	0210	57	2986	57	6718	58	84.4	58
13	4911	62	7096	62	68923	62	2698	62	6427	62	8115	63
14	8927	66	6810	67	9638	67	2411	67	6139	67	7828	67
15	3642	71	6524	71	9350	72	2123	72	4851	72	7537	72
16	3357	76	6238	76	9063	76	1836	77	4563	77	7249	77
17	3072	81	5952	81	8776	81	1548	81	4274	82	6960	82
18	2787	85	5667	86	8489	86	1261	86	3986	86	6671	87
19	2502	90	5381	91	8203	91	0973	91	3698	91	6382	91
20	2218	95	5095	95	7916	96	0686	96	3410	96	6093	96
21	201933	100	184909	100	167629	100	150398	101	133121	101	115804	101
22	1648	104	4523	106	7342	106	0111	105	2833	106	5515	106
23	1363	109	4237	110	7056	110	149823	111	2645	110	5226	111
24	1078	114	3951	115	6769	115	9635	116	2256	115	4937	116
25	0793	119	3665	119	6482	119	9248	120	1968	120	4648	120
26	0508	123	3380	124	6195	124	8860	125	1680	125	4359	125
27	0223	128	3094	129	5908	129	8472	130	1391	130	4070	130
28	194938	133	2808	134	5621	134	8365	135	1103	134	3781	134
29	9653	138	2522	138	5335	138	8097	140	0815	139	3492	140
30	9368	143	2236	143	5048	143	7809	144	0528	144	3203	144
31	199088	147	181960	148	184761	148	147522	149	130238	149	112914	149
32	8798	152	1664	158	4474	153	7234	153	29949	154	2625	154
33	8513	157	1377	157	4187	158	6946	158	9661	159	2336	159
34	8228	162	1091	162	3900	163	6659	163	9373	163	2047	164
35	7943	166	0805	167	3613	167	6371	169	9084	169	1758	169
36	7657	171	0519	172	3326	172	6083	172	8796	173	1469	174
37	7372	176	0233	176	3039	177	5795	177	8507	179	1180	179
38	7087	181	179947	181	2752	182	5508	182	8219	183	0891	184
39	6802	185	9361	186	2465	187	5220	187	7930	187	0602	189
40	6517	190	9376	191	2178	191	4932	192	7642	192	0313	193
41	196231	195	179088	195	161891	196	146844	196	127353	197	110023	198
42	5946	200	8802	200	1604	201	4356	201	7065	202	109734	203
43	5661	205	3516	206	1317	206	4068	206	6773	207	9445	208
44	5376	209	8230	210	1030	210	3781	211	6484	212	9156	212
45	5091	214	7944	214	0743	215	3493	215	6199	216	8867	217
46	4805	219	7657	219	0456	220	3205	220	5910	221	8578	222
47	4520	224	7371	224	168	225	2917	225	5622	226	8289	227
48	4234	228	7085	229	15081	230	2629	231	5333	231	7999	231
49	3949	233	6798	234	9594	234	2341	235	5045	236	7710	236
50	3664	238	6512	238	9307	239	2053	240	4756	240	7421	241
51	193378	243	176226	243	159020	244	141765	244	124447	245	107132	246
52	393	247	5940	248	873	249	1477	249	4179	250	6843	250
53	207	252	5653	253	8445	254	1189	254	3890	250	6553	255
54	2522	257	5367	257	8158	258	0901	259	3602	260	6264	260
55	2237	262	5080	262	7871	263	613	264	3313	264	5975	265
56	1951	267	4794	267	7584	268	0323	269	3024	269	5686	270
57	1666	271	4508	272	7296	273	037	273	2736	274	5396	275
58	1380	276	4221	276	7009	277	13949	278	2447	279	5107	279
59	1095	281	3935	281	6722	282	9461	283	2158	284	4818	284
60	0809	286	3648	286	6435	287	9173	287	1869	288	4529	289

TABLE XVI.—Nat. Cosines.

TABLE XVI.—Nat. Cosines.

N	84°		85°		86°		87°		88°		89°	
	Co-sine.	Parts for "	Co-sine.	Parts for "	Co-sine.	Parts for "	Co-sine.	Parts for "	Co-sine.	Parts for "	Co-sine.	Parts for "
0	104529	0	087156	0	069757	0	062896	0	034899	0	017452	0
1	4239	5	6986	5	9498	5	2046	5	46 9	5	7182	5
2	3950	10	6576	10	9178	10	1755	10	43 8	10	6871	10
3	3661	15	6288	15	8986	15	1465	15	4027	15	6580	15
4	3371	19	5997	19	8596	19	1174	19	3737	19	6289	19
5	3082	24	5707	24	8306	24	0884	24	3446	24	5998	24
6	2792	29	5417	29	8015	29	0593	29	3155	29	5707	29
7	2503	34	5127	34	7725	34	0302	34	2 84	34	5417	34
8	2214	39	4837	39	7435	39	0012	39	2574	39	5126	39
9	1925	44	4547	44	7145	44	0497 21	44	2283	44	48 35	44
10	1635	48	4254	48	6854	48	9131	48	1992	48	4544	48
11	101346	53	083968	53	066564	53	049140	53	031701	53	014253	53
12	1066	58	3678	58	6274	58	2850	58	1411	58	3962	58
13	0767	63	3383	63	5984	63	8530	63	112	63	3671	63
14	0478	68	3098	68	5693	68	8269	68	0829	68	3381	68
15	0188	73	28 8	73	5403	73	7978	73	05 9	73	3090	73
16	090699	77	2518	77	5113	77	7688	77	0248	77	2799	77
17	9909	82	2228	82	4823	82	7397	82	029 57	82	2508	82
18	9320	87	1939	87	4532	87	7107	87	9968	87	2217	87
19	9030	92	1649	92	4242	92	6816	92	9376	92	1926	92
20	8741	97	1359	97	3952	97	6525	97	9085	97	1635	97
21	098451	102	081069	102	063661	102	048235	102	028794	102	011844	102
22	8162	107	0779	107	3871	106	5944	106	8593	106	1034	107
23	7872	112	0489	112	3 81	111	5654	111	8212	111	0763	112
24	7583	116	0199	116	2791	116	5363	116	7922	116	0472	116
25	7293	121	0799 9	121	2500	121	5072	121	7631	121	0181	121
26	7004	126	9619	126	2210	126	4782	126	7340	126	0089 80	126
27	6714	131	9329	131	1920	131	4491	131	7049	131	9599	131
28	6425	136	9039	136	1629	136	4201	136	6759	136	93 8	136
29	6135	141	8749	141	1339	140	3910	140	6468	140	9017	141
30	5846	145	8459	145	1049	145	3619	145	6177	145	8726	145
31	095558	150	078169	150	060758	150	043829	150	025896	150	008496	150
32	5287	155	7879	155	0468	155	3038	155	5695	155	8 45	155
33	4977	160	7589	160	0178	160	2748	160	5395	160	7854	160
34	4688	164	7299	164	069887	165	2457	165	5014	165	7563	165
35	4398	169	7009	169	9597	169	2166	169	4723	170	7272	170
36	4108	174	6719	174	9306	174	1876	174	4432	175	6981	175
37	3819	179	6429	179	9016	179	1585	179	4141	179	6690	179
38	3529	184	6139	184	8726	184	1294	184	3851	184	6400	184
39	3240	189	5849	189	8435	189	1004	189	3560	189	6109	189
40	2950	193	5559	193	8145	194	0713	194	8269	194	5818	194
41	092680	198	075269	198	057854	198	040422	198	022978	199	005527	199
42	2371	203	4979	203	7584	203	0132	203	2637	204	5236	204
43	2081	208	4689	208	7274	208	0398 11	208	2397	209	4945	209
44	1791	213	4399	213	69 3	213	9551	213	2106	213	4654	213
45	1502	218	4109	218	6603	218	9260	218	1815	218	4363	218
46	1212	2 2	3818	222	6402	223	8969	223	1524	223	4072	223
47	0922	227	3528	227	6112	227	8679	227	1233	228	3782	228
48	0633	2 2	3238	232	5822	232	8388	232	0942	233	3491	233
49	0343	237	2948	237	5531	237	8097	237	0652	238	3200	238
50	0053	242	2658	242	5241	242	7807	242	0361	243	2909	243
51	089784	247	072968	247	04496	247	37516	247	020070	247	008118	247
52	9174	252	2078	252	446 1	252	7225	252	019779	252	2827	252
53	9184	257	1788	257	43 9	257	6934	257	9198	257	2036	257
54	8894	261	1497	261	4079	261	6644	261	9197	262	1745	262
55	8606	266	1207	266	3789	266	6353	266	8907	267	1454	267
56	8315	271	0917	271	3498	271	6062	271	8616	272	1164	272
57	8025	276	0627	276	3207	274	5772	276	8325	276	0873	276
58	7735	281	0337	281	2917	281	5481	281	8034	281	0582	281
59	7445	285	0047	285	2626	286	5190	286	7743	286	0291	286
60	7156	290	069757	290	2336	290	4899	290	7452	291	0000	291

TABLE XVI.—Nat. Cosines.

23. TABLES * FOR THE DETERMINATION OF HEIGHTS. By FRANCIS GALTON, M.A., F.R.S.

By the Temperature of Boiling Water, &c.

Enter Table I, p. 182, with the boiling-point at each of the two stations, and extract the numbers that stand opposite to them in the column headed "Altitudes, &c." The difference between these numbers gives the difference of height between the two stations, supposing the mean temperature of the intermediate air to be 32° Fahr. The correction for the temperature of the air, when it differs from this value, is given in Table II. We take the mean of the thermometers (exposed in shade) at the upper and lower stations, and we enter Table II. with that mean value, and the number that stands opposite to it, in the column headed "Multiplier," must be multiplied with the results obtained from Table I. Thus:—

At station A the boiling-point = 195°·1, tabular number = 9040
 „ B „ = 210°·3, „ = 887

Approximate difference of height = 8153 feet.

To correct for temperature of intermediate air:—

At station A, temp. of air = 65° Fahr.

„ B, „ = 73° „

2) 138

69 = mean temperature of intermediate air.

* These extended Tables will give much facility to the traveller both in calculating altitudes and in checking the index error of the aneroid, by means of the boiling-point thermometer. I have computed Table I. from Tables XXVI. and II., in the hypsometric series in Guyot's collection. It did not seem worth while to correct the figures thence obtained for the slight excess of temperature, viz.: c°·015 Fahr., of the French boiling point over that of the English. It is too small to be sensible in ordinary instruments, and it becomes totally unimportant in determining *differences* of level, or *changes* in the index error of an aneroid.—F. GALTON.

In Table II. the multiplier corresponding to 69° is 1.082 , and $1.082 \times 8153 = 8821$ (neglecting decimal fractions).

In those rare cases where greater altitudes are dealt with than are included within the limits of the table, the traveller should allow 570 feet for the difference between 185° and 184° ; 572 feet for that between 184° and 183° ; 574 feet for the next interval, and so on.

TABLE I.

Boiling point Fahr.	Altitude above level at which water boils at 212° (temp. of intermediate air being 32° F.).	Approximate corresponding height of aneroid or barometer.	Boiling point Fahr.	Altitude above level at which water boils at 212° (temp. of intermediate air being 32° F.).	Approximate corresponding height of aneroid or barometer.	Boiling point Fahr.	Altitude above level at which water boils at 212° (temp. of intermediate air being 32° F.).	Approximate corresponding height of aneroid or barometer.
185.0	14698	17.048	188.6	12660	18.432	192.2	10644	19.910
.1	14641	17.085	.7	12603	18.472	.3	10588	19.952
.2	14584	17.122	.8	12547	18.512	.4	10533	19.995
.3	14528	17.160	.9	12490	18.552	.5	10477	20.037
.4	14471	17.197	189.0	12434	18.592	.6	10422	20.080
.5	14414	17.235	.1	12377	18.632	.7	10366	20.123
.6	14357	17.272	.2	12321	18.672	.8	10310	20.166
.7	14300	17.310	.3	12265	18.712	.9	10255	20.208
.8	14244	17.348	.4	12209	18.753	193.0	10199	20.251
.9	14187	17.385	.5	12153	18.793	.1	10144	20.294
186.0	14130	17.423	.6	12096	18.833	.2	10088	20.338
.1	14073	17.461	.7	12040	18.874	.3	10033	20.381
.2	14017	17.499	.8	11984	18.914	.4	9978	20.424
.3	13960	17.537	.9	11928	18.955	.5	9923	20.467
.4	13903	17.575	190.0	11872	18.996	.6	9867	20.511
.5	13847	17.614	.1	11816	19.036	.7	9812	20.554
.6	13790	17.652	.2	11760	19.077	.8	9757	20.598
.7	13733	17.690	.3	11704	19.118	.9	9701	20.641
.8	13676	17.729	.4	11648	19.159	194.0	9646	20.685
.9	13620	17.767	.5	11592	19.200	.1	9591	20.729
187.0	13563	17.806	.6	11536	19.241	.2	9536	20.773
.1	13506	17.844	.7	11480	19.283	.3	9481	20.817
.2	13450	17.883	.8	11424	19.324	.4	9426	20.861
.3	13394	17.922	.9	11368	19.365	.5	9371	20.905
.4	13337	17.961	191.0	11312	19.407	.6	9315	20.949
.5	13281	18.000	.1	11257	19.448	.7	9260	20.993
.6	13224	18.039	.2	11201	19.490	.8	9205	21.038
.7	13167	18.078	.3	11146	19.532	.9	9150	21.082
.8	13111	18.117	.4	11090	19.573	195.0	9095	21.126
.9	13054	18.156	.5	11034	19.615	.1	9040	21.171
188.0	12998	18.195	.6	10978	19.657	.2	8985	21.216
.1	12942	18.235	.7	10922	19.699	.3	8930	21.260
.2	12885	18.274	.8	10867	19.741	.4	8875	21.305
.3	12829	18.314	.9	10811	19.783	.5	8820	21.350
.4	12772	18.353	192.0	10755	19.825	.6	8765	21.395
.5	12716	18.393	.1	10699	19.868	.7	8710	21.440

TABLE I.—*continued.*

Boiling point Fahr.	Altitude above level at which water boils at 212° (temp. of intermediate air being 32° F.).	Approximate corresponding height of aneroid or barometer.	Boiling point Fahr.	Altitude above level at which water boils at 212° (temp. of intermediate air being 32° F.).	Approximate corresponding height of aneroid or barometer.	Boiling point Fahr.	Altitude above level at which water boils at 212° (temp. of intermediate air being 32° F.).	Approximate corresponding height of aneroid or barometer.
195·8	8655	21·485	200·5	6095	21·697	205·2	3574	26·096
·9	8600	21·530	·6	6041	23·746	·3	3521	26·149
196·0	8545	21·576	·7	5987	23·795	·4	3468	26·202
·1	8490	21·621	·8	5933	23·845	·5	3416	26·255
·2	8435	21·666	·9	5879	23·894	·6	3363	26·309
·3	8381	21·712	201·0	5825	23·943	·7	3310	26·362
·4	8326	21·751	·1	5771	23·993	·8	3256	26·416
·5	8271	21·803	·2	5717	24·042	·9	3203	26·470
·6	8216	21·849	·3	5663	24·092	206·0	3151	26·523
·7	8161	21·895	·4	5609	24·142	·1	3098	26·577
·8	8107	21·941	·5	5556	24·191	·2	3045	26·631
·9	8052	21·987	·6	5502	24·241	·3	2992	26·685
197·0	7997	22·033	·7	5448	24·291	·4	2939	26·740
·1	7942	22·079	·8	5394	24·341	·5	2886	26·794
·2	7888	22·125	·9	5340	24·391	·6	2833	26·848
·3	7833	22·172	202·0	5286	24·442	·7	2780	26·903
·4	7779	22·218	·1	5232	24·492	·8	2727	26·957
·5	7724	22·264	·2	5178	24·542	·9	2674	27·012
·6	7669	22·311	·3	5124	24·593	207·0	2622	27·066
·7	7615	22·358	·4	5070	24·644	·1	2569	27·121
·8	7560	22·404	·5	5017	24·694	·2	2516	27·176
·9	7506	22·451	·6	4964	24·745	·3	2464	27·231
198·0	7451	22·498	·7	4910	24·796	·4	2411	27·286
·1	7397	22·545	·8	4856	24·847	·5	2358	27·341
·2	7343	22·592	·9	4802	24·898	·6	2305	27·397
·3	7289	22·639	203·0	4749	24·949	·7	2252	27·452
·4	7234	22·686	·1	4695	25·000	·8	2199	27·507
·5	7180	22·734	·2	4641	25·051	·9	2146	27·563
·6	7125	22·781	·3	4588	25·103	208·0	2094	27·618
·7	7071	22·829	·4	4535	25·154	·1	2041	27·674
·8	7016	22·876	·5	4482	25·206	·2	1989	27·730
·9	6962	22·924	·6	4428	25·257	·3	1936	27·786
199·0	6908	22·971	·7	4375	25·309	·4	1884	27·842
·1	6854	23·019	·8	4322	25·361	·5	1831	27·898
·2	6800	23·067	·9	4268	25·413	·6	1778	27·954
·3	6745	23·115	204·0	4215	25·465	·7	1726	28·011
·4	6691	23·163	·1	4161	25·517	·8	1673	28·067
·5	6637	23·211	·2	4107	25·569	·9	1621	28·123
·6	6583	23·259	·3	4053	25·621	209·0	1568	28·180
·7	6529	23·308	·4	4000	25·674	·1	1516	28·237
·8	6474	23·356	·5	3947	25·726	·2	1463	28·293
·9	6420	23·405	·6	3894	25·779	·3	1411	28·350
200·0	6366	23·453	·7	3841	25·831	·4	1358	28·407
·1	6312	23·502	·8	3788	25·884	·5	1306	28·464
·2	6258	23·550	·9	3735	25·937	·6	1254	28·521
·3	6203	23·599	205·0	3682	25·990	·7	1201	28·579
·4	6149	23·648	·1	3625	26·043	·8	1149	28·636

TABLE I.—continued.

Boiling point Fahr.	Altitude above level at which water boils at 212° (temp. of intermediate air being 32° F.).	Approximate corresponding height of aneroid or barometer.	Boiling point Fahr.	Altitude above level at which water boils at 212° (temp. of intermediate air being 32° F.).	Approximate corresponding height of aneroid or barometer.	Boiling point Fahr.	Altitude above level at which water boils at 212° (temp. of intermediate air being 32° F.).	Approximate corresponding height of aneroid or barometer.
200°·9	1066	28·693	211°·6	208	29·684	213°·3	— 673	30°·705
210°·0	1044	28·751	·7	196	29°·744	·4	— 724	30°·766
·1	992	28·809	·8	104	29°·803	·5	— 776	30°·827
·2	939	28·866	·9	52	29°·862	·6	— 828	30°·888
·3	887	28·924	212°·0	0	29°·922	·7	— 880	30°·949
·4	835	28·982	·1	— 52	29°·981	·8	— 932	31°·010
·5	783	29°·040	·2	— 104	30°·041	·9	— 983	31°·071
·6	730	29°·098	·3	— 155	30°·101	214°·0	— 1035	31°·132
·7	678	29°·156	·4	— 207	30°·161	·1	— 1086	31°·194
·8	626	29°·215	·5	— 259	30°·221	·2	— 1138	31°·256
·9	573	29°·273	·6	— 311	30°·281	·3	— 1189	31°·318
211°·0	521	29°·331	·7	— 363	30°·341	·4	— 1241	31°·380
·1	469	29°·390	·8	— 414	30°·401	·5	— 1293	31°·442
·2	417	29°·449	·9	— 466	30°·461	·6	— 1344	31°·504
·3	365	29°·508	213°·0	— 518	30°·522	·7	— 1396	31°·566
·4	313	29°·566	·1	— 570	30°·583	·8	— 1447	31°·628
·5	261	29°·625	·2	— 621	30°·644	·9	— 1549	31°·690

TABLE II.—CORRECTION FOR TEMPERATURE OF INTERMEDIATE AIR.

Mean temperature of intermediate air.	Multiplier.	Mean temperature of intermediate air.	Multiplier.	Mean temperature of intermediate air.	Multiplier.	Mean temperature of intermediate air.	Multiplier.
20°	0·9734	37	1·0111	54	1·0488	70	1·0844
21	0·9756	38	1·0133	55	1·0511	71	1·0866
22	0·9778	39	1·0155	56	1·0533°	72	1·0888
23	0·9801	40	1·0177	57	1·0555	73	1·0911
24	0·9823	41	1·0199	58	1·0577	74	1·0933
25	0·9845	42	1·0222	59	1·0599	75	1·0955
26	0·9867	43	1·0244	60	1·0622	76	1·0977
27	0·9889	44	1·0266	61	1·0644	77	1·0999
28	0·9912	45	1·0288	62	1·0666	78	1·1022
29	0·9934	46	1·0311	63	1·0688	79	1·1044
30	0·9956	47	1·0333	64	1·0711	80	1·1066
31	0·9978	48	1·0355	65	1·0733	81	1·1088
32	1·0000	49	1·0377	66	1·0755	82	1·1111
33	1·0022	50	1·0399	67	1·0777	83	1·1133
34	1·0044	51	1·0422	68	1·0799	84	1·1156
35	1·0066	52	1·0444	69	1·0822	85	1·1178
36	1·0088	53	1·0466				

When the boiling-point at the upper station alone is observed, we have no option but to *assume* 30·00 inches, or a little less, as the average height of the barometer at the level of the sea. The altitude of the upper station is then at once approximately obtained by inspection of Table I; correcting for assumed temperature of the air at the sea-level.

By Barometer or Aneroid.

The small but complete Tables (pp. 187–88) will be especially useful to those who carry a mountain barometer and are anxious to make accurate determinations, but are not furnished with larger tables. These are calculated by Loomis, and are extracted from Guyot's collection.

Part I. gives the altitude, subject to correction, for the temperature of the air, and for the other influences which are the subjects of Parts II., III., IV., and V.

Method of Computation.—(1) Take from Part I. the two numbers corresponding to the two barometric heights; (2) from their difference subtract the correction found in Part II., with the difference between the thermometers that are attached to the barometers (*Mem.* this correction is not wanted for aneroids, for their works are mechanically compensated for temperature); (3) for the temperature of the intermediate air between the two stations, multiply the nine-hundredth part of the value already obtained by the difference between the sum of the temperatures at the two stations and 64° . This correction is additive when the sum of the temperatures exceeds 64° , otherwise it is subtractive; or, what comes to the same thing, use the multiplier already given in Table II. p. 184. (4) For further precision take corrections from Parts III. and IV., also from Part V., when the lower station is so high as to bring the case within the range of that table:—

<i>(Example.)</i>	Upper Station.	Lower Station by Sea.
Thermometer in open air	70° 3	77° 5
Thermometer in barometer	70° 3	77° 5
	Inches.	Inches.
Barometer	23° 66	30° 046
Latitude 21°.		
Part I. gives { for 30° 046 inches		27649·7
{ for 23° 66 inches		21406·9

Difference		6242·8
Part II. gives for 77° 5 - 70° 3 (= 7° 2)		- 16·9

Approximate altitude		6225·9
$\frac{6225\cdot9}{900} \times \{77^\circ 5 + 70^\circ 3 - 64\} = 6\cdot918 \times 83\cdot8 =$		+ 579·7*

Nearly correct altitude		6805·6
Part III. gives for above altitude and latitude 21°		+ 13·3
Part IV. gives for above altitude		+ 19·3
Part V. is not used in this case		0·0

Correct height above sea		6838·2 feet.

* If Table II., p. 184, had been used, we should have written—

$$\frac{77^\circ 5 + 70^\circ 3}{2} = 74^\circ \text{ nearly}$$

The corresponding multiplier is 1·0933

$$1\cdot0933 \times 6225\cdot9 = 6806\cdot8.$$

PART I.

ARGUMENT, THE OBSERVED HEIGHT OF THE BAROMETER AT EITHER STATION.

Inches.	Feet.	Diff.	Inches.	Feet.	Diff.	Inches.	Feet.	Diff.	Inches.	Feet.	Diff.
11.0	1396.9		16.0	11186.3		21.0	18391.0		26.0	23871.0	
11.1	1633.3	236.4	16.1	11349.1	162.8	21.1	18415.1	124.1	26.1	23971.3	100.3
11.2	1867.6	234.3	16.2	11510.9	161.8	21.2	18438.7	123.6	26.2	24071.2	99.9
11.3	2099.9	232.3	16.3	11671.7	160.8	21.3	18661.6	122.9	26.3	24170.7	99.5
11.4	2310.1	230.2	16.4	11831.5	159.8	21.4	18784.0	122.4	26.4	24269.8	99.1
11.5	2558.3	228.2	16.5	11990.3	158.8	21.5	18905.8	121.8	26.5	24368.6	98.8
11.6	2784.5	226.2	16.6	12148.2	157.9	21.6	19027.0	121.2	26.6	24467.0	98.4
11.7	3008.7	224.2	16.7	12305.1	156.9	21.7	19147.7	120.7	26.7	24565.1	98.1
11.8	3231.1	222.4	16.8	12461.0	155.9	21.8	19267.8	120.1	26.8	24662.7	97.7
11.9	3451.6	220.5	16.9	12616.1	155.1	21.9	19387.4	119.6	26.9	24760.0	97.3
12.0	3670.2	218.6	17.0	12770.2	154.1	22.0	19506.4	119.0	27.0	24857.0	97.0
12.1	3887.0	216.8	17.1	12923.5	153.3	22.1	19624.9	118.5	27.1	24953.6	96.6
12.2	4102.0	215.0	17.2	13075.8	152.3	22.2	19742.9	118.0	27.2	25049.8	96.2
12.3	4315.3	213.3	17.3	13227.3	151.5	22.3	19860.3	117.4	27.3	25145.7	95.9
12.4	4526.9	211.6	17.4	13377.9	150.6	22.4	19977.2	116.9	27.4	25241.2	95.5
12.5	4736.7	209.8	17.5	13527.6	149.7	22.5	20093.6	116.4	27.5	25336.4	95.2
12.6	4944.9	208.2	17.6	13676.5	148.9	22.6	20209.4	115.8	27.6	25431.2	94.8
12.7	5151.4	206.5	17.7	13824.5	148.0	22.7	20324.8	115.4	27.7	25525.7	94.5
12.8	5356.4	205.0	17.8	13971.7	147.2	22.8	20439.6	114.8	27.8	25619.9	94.2
12.9	5559.7	203.3	17.9	14118.0	146.3	22.9	20554.0	114.4	27.9	25713.7	93.8
13.0	5761.4	201.7	18.0	14263.6	145.6	23.0	20667.8	113.8	28.0	25807.1	93.4
13.1	5961.6	200.2	18.1	14408.3	144.7	23.1	20781.1	113.3	28.1	25900.3	93.2
13.2	6160.3	198.7	18.2	14552.3	144.0	23.2	20894.0	112.9	28.2	25993.1	92.8
13.3	6357.5	197.2	18.3	14695.4	143.1	23.3	21006.4	112.4	28.3	26085.6	92.5
13.4	6553.2	195.7	18.4	14837.8	142.4	23.4	21118.3	111.9	28.4	26177.7	92.1
13.5	6747.5	194.3	18.5	14979.4	141.6	23.5	21229.7	111.4	28.5	26269.6	91.9
13.6	6940.3	192.8	18.6	15120.3	140.9	23.6	21340.6	110.9	28.6	26361.1	91.5
13.7	7131.7	191.4	18.7	15260.3	140.0	23.7	21451.1	110.5	28.7	26452.3	91.2
13.8	7321.7	190.0	18.8	15399.7	139.4	23.8	21561.1	110.0	28.8	26543.2	90.9
13.9	7510.3	188.6	18.9	15538.3	138.6	23.9	21670.6	109.5	28.9	26633.7	90.5
14.0	7697.6	187.3	19.0	15676.2	137.9	24.0	21779.7	109.1	29.0	26724.0	90.3
14.1	7883.6	186.0	19.1	15813.3	137.1	24.1	21888.4	108.7	29.1	26813.7	89.9
14.2	8068.2	184.6	19.2	15949.8	136.4	24.2	21996.6	108.2	29.2	26903.5	89.6
14.3	8251.5	183.3	19.3	16085.5	135.7	24.3	22104.3	107.7	29.3	26992.8	89.3
14.4	8433.6	182.1	19.4	16220.5	135.0	24.4	22211.6	107.3	29.4	27081.9	89.1
14.5	8614.4	180.8	19.5	16354.8	134.3	24.5	22318.4	106.8	29.5	27170.6	88.7
14.6	8794.0	179.6	19.6	16488.5	133.7	24.6	22424.8	106.4	29.6	27259.0	88.4
14.7	8972.3	178.3	19.7	16621.4	132.9	24.7	22530.8	106.0	29.7	27347.1	88.1
14.8	9149.5	177.2	19.8	16753.7	132.3	24.8	22636.4	105.6	29.8	27434.9	87.8
14.9	9325.5	176.0	19.9	16885.3	131.6	24.9	22741.5	105.1	29.9	27522.5	87.6
15.0	9500.3	174.8	20.0	17016.3	131.0	25.0	22846.3	104.8	30.0	27609.7	87.2
15.1	9673.8	173.5	20.1	17146.6	130.3	25.1	22950.6	104.3	30.1	27696.6	86.9
15.2	9846.2	172.4	20.2	17276.3	129.7	25.2	23054.4	103.8	30.2	27783.3	86.7
15.3	10017.5	171.3	20.3	17405.3	129.0	25.3	23157.9	103.5	30.3	27869.7	86.4
15.4	10187.7	170.2	20.4	17533.7	128.4	25.4	23261.0	103.1	30.4	27955.7	86.0
15.5	10356.0	169.1	20.5	17661.4	127.7	25.5	23363.6	102.6	30.5	28041.3	85.8
15.6	10524.8	168.0	20.6	17788.6	127.2	25.6	23465.9	102.3	30.6	28127.1	85.6
15.7	10691.8	167.0	20.7	17915.1	126.5	25.7	23567.7	101.8	30.7	28212.1	85.2
15.8	10857.7	165.9	20.8	18041.1	125.9	25.8	23669.2	101.5	30.8	28297.3	85.0
15.9	11022.5	164.8	20.9	18166.3	125.3	25.9	23770.3	101.1	30.9	28382.0	84.7
16.0	11186.3	163.8	21.0	18291.0	124.7	26.0	23871.0	100.7	31.0	28466.4	84.4

CORRECTION DUE TO T-T', OR THE DIFFERENCE OF THE (NOT FOR THAT OF THE INTERMEDIATE AIR) TEMPERATURES OF THE BAROMETERS THEMSELVES, AT THE TWO STATIONS.

This Correction is Negative when the Temperature at the Upper Station is lowest, and vice versa.

T-T'	Correction.	T-T'	Correction.	T-T'	Correction.	T-T'	Correction.	T-T'	Correction.	T-T'	Correction.
Fahr.	Feet.	Fahr.	Feet.	Fahr.	Feet.	Fahr.	Feet.	Fahr.	Feet.	Fahr.	Feet.
0		0		0		0		0		0	
1	2.3	14	32.8	27	63.2	40	93.6	53	124.1	66	154.5
2	4.7	15	35.1	28	65.5	41	96.0	54	126.4	67	156.8
3	7.0	16	37.5	29	67.9	42	98.3	55	128.7	68	159.2
4	9.4	17	39.8	30	70.2	43	100.7	56	131.1	69	161.5
5	11.7	18	42.1	31	72.6	44	103.0	57	133.4	70	163.9
6	14.0	19	44.5	32	74.9	45	105.3	58	135.8	71	166.2
7	16.4	20	46.8	33	77.3	46	107.7	59	138.1	72	168.6
8	18.7	21	49.2	34	79.6	47	110.0	60	140.4	73	170.9
9	21.1	22	51.5	35	81.9	48	112.4	61	142.8	74	173.3
10	23.4	23	53.8	36	84.3	49	114.7	62	145.1	75	175.6
11	25.8	24	56.2	37	86.6	50	117.0	63	147.5	76	177.9
12	28.1	25	58.5	38	89.0	51	119.4	64	149.8	77	180.3
13	30.4	26	60.9	39	91.3	52	121.7	65	152.2	78	182.6

PART III. CORRECTION DUE TO THE CHANGE OF GRAVITY FROM THE LATITUDE OF 45° TO THE LATITUDE OF THE PLACE OF OBSERVATION. <i>Positive from Lat. 0° to 45°; Negative from Lat. 45° to 90°.</i>							PART IV. CORRECTION FOR DECREASE OF GRAVITY ON A VERTICAL. <i>Always Positive.</i>		PART V. CORRECTION DUE TO THE HEIGHT OF THE LOWER STATION. <i>Always Positive.</i>							App. Alt.	
Latitude.									Height of Barometer at Lower Station.								
App. Alt.	0°	10°	20°	30°	40°	45°	Feet.	Feet.	16 in.	18 in.	20 in.	22 in.	24 in.	26 in.	28 in.	Feet.	
	90°	80°	70°	60°	50°												
Feet.	Feet.	Feet.	Feet.	Feet.	Feet.	Feet.	Feet.	Feet.	Feet.	Feet.	Feet.	Feet.	Feet.	Feet.	Feet.	Feet.	Feet.
1000	2.6	2.5	2.0	1.3	0.5	0	2.5	1.6	1.3	1.0	0.8	0.6	0.4	0.2	1000		
2000	5.3	5.0	4.1	2.6	0.9	0	5.2	3.1	2.5	2.0	1.5	1.1	0.7	0.3	2000		
3000	7.9	7.5	6.1	4.0	1.4	0	7.9	4.7	3.8	3.0	2.3	1.7	1.1	0.5	3000		
4000	10.6	10.0	8.1	5.3	1.8	0	10.8	6.3	5.1	4.0	3.1	2.2	1.4	0.7	4000		
5000	13.2	12.4	10.1	6.6	2.3	0	13.7	7.8	6.4	5.0	3.8	2.8	1.8	0.8	5000		
6000	15.9	14.9	12.2	7.9	2.8	0	16.7	9.4	7.6	6.0	4.6	3.3	2.1	1.0	6000		
7000	18.5	17.4	14.2	9.3	3.2	0	19.9	11.0	8.9	7.1	5.4	3.9	2.5	1.2	7000		
8000	21.2	19.9	16.2	10.6	3.7	0	23.1	12.5	10.2	8.1	6.2	4.4	2.8	1.3	8000		
9000	23.8	22.4	18.3	11.9	4.1	0	26.4	14.1	11.4	9.1	6.9	5.0	3.2	1.5	9000		
10000	26.5	24.9	20.3	13.2	4.6	0	29.8	15.7	12.7	10.1	7.7	5.5	3.5	1.7	10000		
11000	29.1	27.4	22.3	14.6	5.1	0	33.3	17.2	14.0	11.1	8.5	6.1	3.9	1.8	11000		
12000	31.8	29.9	24.4	15.9	5.5	0	36.9	18.8	15.3	12.1	9.2	6.6	4.2	2.0	12000		
13000	34.4	32.4	26.4	17.2	6.0	0	40.6	20.4	16.5	13.1	10.0	7.2	4.6	2.2	13000		
14000	37.1	34.9	28.4	18.5	6.4	0	44.4	21.9	17.8	14.1	10.8	7.7	4.9	2.3	14000		
15000	39.7	37.3	30.4	19.9	6.9	0	48.3	23.5	19.1	15.1	11.5	8.3	5.1	2.5	15000		
16000	42.4	39.8	32.5	21.2	7.4	0	52.3	25.1	20.3	16.1	12.3	8.8	5.6	2.7	16000		
17000	45.0	42.3	34.5	22.5	7.8	0	56.4	26.6	21.6	17.1	13.1	9.4	6.0	2.8	17000		
18000	47.7	44.8	36.5	23.8	8.3	0	60.5	28.2	22.9	18.1	13.8	9.9	6.3	3.0	18000		
19000	50.3	47.3	38.6	25.2	8.7	0	64.8	29.8	24.1	19.2	14.6	10.5	6.7	3.2	19000		
20000	53.0	49.8	40.6	26.5	9.2	0	69.2	31.3	25.4	20.3	15.4	11.0	7.0	3.3	20000		
21000	55.6	52.3	42.6	27.8	9.7	0	73.6	32.9	26.7	21.2	16.1	11.6	7.4	3.5	21000		
22000	58.3	54.8	44.7	29.1	10.1	0	78.2	34.5	28.0	22.2	16.9	12.1	7.7	3.7	22000		
23000	60.9	57.1	46.7	30.5	10.6	0	82.9	36.0	29.2	23.2	17.7	12.7	8.1	3.8	23000		
24000	63.6	59.8	48.7	31.8	11.0	0	87.6	37.6	30.4	24.2	18.5	13.2	8.4	4.0	24000		
25000	66.2	62.2	50.7	33.1	11.5	0	92.5	39.1	31.8	25.2	19.2	13.8	8.8	4.1	25000		

II.

METEOROLOGY.

By R. STRACHAN (of the Meteorological Office).

Travellers may make useful meteorological observations for three distinct purposes: 1st, for contouring, or determining elevation above the sea; 2nd, for extending our knowledge of climate; 3rd, for aiding synoptic investigation; while for their own daily knowledge of the weather, they will be useful and interesting.

Whatever results may be deduced from the observations, the original register should be carefully preserved, to afford opportunity of investigating such anomalies as may at a future time call for inquiry. Every observation or set of observations necessarily requires a statement of the time and place. It is especially necessary to record the name of the place, or the position, that is, the latitude and longitude, where observations are made on the march. Observations intended to aid synoptic investigation must be made at some definite instant of Greenwich time. At present the Meteorological Bureau of the United States asks for observations made at 12h. 8m. P.M. Greenwich time.

Travellers while on the march may always keep a valuable meteorological note-book, but, when resident at any place for some time, a meteorological register, kept methodically, becomes more valuable. The hours of observing while on the march will be dependent on the times of encamping and decamping, or on the necessity for determining some height barometrically. In residence, the hours of observing should be at intervals of 12, 8, 6, or 4 hours, always dividing the twenty-four hours into equal parts, as 2, 3, 4, or 6; thus, 4 A.M., 8, noon, 4 P.M., 8, and midnight, are the most advisable hours, local time, for observing.

The meteorological instruments which a traveller will chiefly use are barometers and thermometers. Whether a barometer or its substitute, an aneroid, be used for contouring purposes, the same can be set up and registered in residence. It is advisable to keep all instruments in the shade, but it is especially necessary to do so with thermometers intended to show the temperature of the air, nevertheless they must be exposed to the free movement of the air. Inside a tent, a hut, or a verandah, they will commonly be too much sheltered. On the march, or whenever good shade cannot be had, it will be found a good plan to attach a string to the top of a pocket thermometer, and whirl the instrument round at arm's

length for about half a minute. By this method even in full sunshine a very close approximation to the true temperature of the air may be had.

Every instrument used ought to be compared with a standard and tested thoroughly, both before commencing and after completing the journey. This is done at a trifling cost at the Kew Observatory. Instrumental corrections should be carefully recorded in the register.

A rain-gauge consists of a funnel, a collector, and a glass measure. The funnel should have a deep circular aperture for the reception of the rain not less than 8 inches in diameter. All smaller sizes are wanting in accuracy, nevertheless they will be preferred for portability, and if so, care should be taken that they are really made to the size intended.

A small anemometer, or wind-gauge, by Lowndes, which fits into a small cubic box, about 4 or 5 inches in each dimension, will be found the best adapted for the requirements of travellers.

Artificial shade may be made for the thermometers, maximum, minimum, dry-bulb, and wet-bulb, when in residence, by means of a louvre-work box, about 18 to 24 inches in height, width, and depth. It must be roofed at top to keep off sunshine and rain, and have sides like Venetian blinds, through which the air may pass with freedom. It should be erected 4 feet above the ground, on wooden supports. The bottom of the cage should be full of perforations, but not entirely open to radiation from the ground beneath it. The thermometer should be disposed about the middle of the cage.

The observer should be careful to make it quite clear whether the directions of the wind, and bearings generally, are by compass, or referred to the astronomical north, south, east, and west. The wind's force and the weather should be noted according to the Beaufort system of notation, as given in most modern works on meteorology.

In mountain districts where the conditions of temperature are fairly similar the traveller will find the amount of rain or snowfall roughly indicated by the height and variations of the snow-line, the existence of glaciers, and the lowest point to which they descend. This, with any evidence, local or oral, of recent oscillations of the ice, he should note, wherever possible, on *both* sides of the chain. Snow-beds, which are not necessarily indications of perpetual snow, should be distinguished from glaciers, a point frequently overlooked. The average height, not only of the neighbouring chains, but separately of their peaks and passes, should be ascertained; a deep gap often determines the climate of a large tract of country.

III.

GEOLOGY.

By W. T. BLANFORD, F.R.S.

A traveller who has not devoted some time to studying geology in the field must not be surprised or disappointed if the rocks of any country which he may happen to traverse appear to him a hopeless puzzle. If he desires to investigate the geological structure of an unknown region, he should previously devote some time to mastering, with the aid of a good geological map and description, the details of a well-known tract.

Under the term "Geological Observations," two very distinct types of inquiry are commonly confounded. The first of these, to which the name of Geological Investigation ought properly to be restricted, consists in an examination of the rocks of a country as a whole, so as to enable a geological map, or, at all events, geological sections, to be constructed. This demands a knowledge of rocks (petrology), some acquaintance with the details of geological surveying, and, usually, with the elements of palæontology—a science that, in its turn, requires a preliminary study of biology, and especially of zoology. Despite all these hard terms, any intending traveller who has a taste for geology—if he has none he had better not waste time upon the subject—will find that a few months' study in any good museum, a course of geological lectures, and, above all, a few days in the field with a good geologist, will start him very fairly equipped with the great requisite to all successful scientific investigation, a knowledge of how to observe, and what to observe.

The term "Geological Observations" is, however, often, but incorrectly, used in a second sense, which implies a restriction of the observations to the useful minerals found in any country, or to what is termed economic geology. Here also a preliminary knowledge of the elements of geological science will be found very useful, and will frequently enable the traveller to form much more trustworthy conclusions as to the nature and value of mineral deposits than he could without such a guide. But the essential point is to recognise a valuable mineral when seen, and for this a slight knowledge of mineralogy is requisite.

Outfit.—The essential articles of a geologist's outfit are neither numerous nor cumbrous. A very large proportion of the known geology of the world has been made out with no more elaborate appliances than a hammer, a pocket compass, with a small index to serve as a clinometer, a pocket lens, a note-book and a pencil. No scientific observer has to depend more on his own knowledge and faculty for observation, and less on instrumental appliances, than a geologist.

The best hammer for general purposes should weigh from 1 to 2 lbs., and should have a square flat end, and a straight cutting end—the latter may be horizontal or vertical, according to fancy. The ends should be of steel, not too highly tempered. The hole for the handle should be as large as possible (with a small hole the handles are so weak as to be liable to break), and the handle should be secured in the hole by a wooden wedge, and an iron one driven into and across the wooden one. It is advisable to take a few spare ash handles. Cut a foot-measure in notches on the handle—this is very useful for measuring thickness of beds, &c. It is as well to have more than one hammer in case of loss, and if fossil-collecting is anticipated, at least one heavy hammer, with one end fashioned to serve as a pick, three or four cold chisels of various sizes, and a short crow-bar will be found useful. Excellent geological hammers are those used by the Irish Geological Survey, and made by Kennan, of Dublin. In London, hammers, chisels, &c., may be procured of J. R. Gregory, 88, Charlotte Street, Fitzroy Square; or of Messrs. Buck, 242, Tottenham Court Road.

A very good pocket compass, the shape and size of a watch, with a clinometer arm, is made by Troughton and Simms, 138, Fleet Street. The use of the clinometer is for measuring the angle of dip in rocks. The elaborate instruments used for mining purposes are unnecessary to the geologist. If more accuracy of measurement is required than is afforded by looking at a bed, a section, or a hill-side, and holding the straight edge attached to the compass parallel to the dip, and if a surface can be found that affords the exact inclination, it is usually practicable, by means of a note-book laid on the rock surface, to obtain a plane sufficiently close to that at which the beds dip to enable the angle to be determined with a very short straight edge. As a rule, except with very low angles of dip, the variation in the inclination of the rocks themselves exceeds the limits of error of the instrument. A little care, however, is necessary in taking dips.

A prismatic compass and an aneroid are frequently of great service: the former to determine the position on the map, if one exists, and to aid in making a rough map, if there is none; and the latter to estimate roughly the heights on the road travelled, especially in mountainous countries, and also to measure the thickness of horizontal beds. Both form a part of the outfit of most modern travellers. A good aneroid gives sufficiently accurate determinations of height for a rough but adequate geological section across any country, if the distances are known.

Collections.—Geological specimens require little more than paper and boxes for packing. Occasionally fossils or minerals are fragile and need tow or grass to protect them from injury; but there is no risk from the animal and vegetable enemies of zoological or botanical collections. The only important point to be borne in mind is that *every specimen should be labelled on the spot*, or, at all events, in the course of the day on which it is collected. Strong paper is best for labels, and these should not be put up in contact with the rock-fragments themselves, or they will be worn by sharp edges and become illegible, if not rubbed to fragments. Always wrap each specimen in paper, or some substitute, then add the label, and then an outer covering. The label,* if nothing else is written, should always record the locality.

A collection of rock-specimens may show what kinds of rock occur in a country, but the information afforded is very meagre, and, in general, of very small value. Such collections, indeed, unless made by a geologist, and accompanied by notes, are scarcely worth the carriage. If such specimens are taken, care should be used to select them from the rocks in place, not from loose blocks that may have been transported from a distance, and no fragments of spar or crystals should be collected merely because they are pretty.

In taking specimens of useful minerals, such as coal or metallic ores, the traveller should always endeavour to procure them himself from

* Travellers in tropical countries will do wisely to poison all their labels before using them, to preserve them from attacks of insects and mites. Washing with a very weak solution of corrosive sublimate is an efficient plan. A large number of labels, with the collector's name printed on them, may be taken, and if made of strong thin paper they will not occupy much space. Bank note paper is well adapted for the purpose. Any writing should be if possible in ink; if not, a very hard black pencil should be used.

the place of occurrence, and if such are brought to him by natives he should, if practicable, visit the locality whence the samples were procured. The value of all useful minerals depends both on quality and quantity; the former can to some extent be ascertained from a sample, but the amount available can only be estimated after a visit to the locality. Most metallic ores occur in veins or lodes. These were originally cracks in the rock, and have been irregularly filled with minerals, different from those in the neighbourhood. It is, however, very difficult, and often impossible, to estimate from surface examination whether the quantity of ore occurring in veins is likely to prove large; some idea may possibly be obtained if underground workings exist. Many of the ores of iron, some of those of other metals, and all coal and salt occur in beds, and here it is important to see what is the thickness, and to ascertain whether the mineral is equally pure throughout. Iron ores occur in most countries, and unless very pure and within easy reach of water-carriage are not likely to be worth transport. The value of salt also depends on facilities for carriage. Coal, however, may be of value anywhere; but it is improbable that seams of less thickness than four or five feet can be of much use, except in countries where there is a skilled mining population and a considerable demand for the mineral. It does not follow because much thinner seams are sufficiently valuable to be worked in Western Europe that they would pay for extraction in a country where the mechanical arts are less advanced. Still the occurrence of thin seams is worthy of record, as thicker deposits may exist in the neighbourhood. It must not be inferred, however, that a seam of small thickness at the surface will become thicker below. The reverse is equally probable.

A blow-pipe is extremely useful for ascertaining the nature of ores, and for determining minerals generally, and a small blow-pipe case might be added to a traveller's kit, if he thinks it probable that he may meet with minerals in any quantity. But in general they are not to be found in such profusion as to render it difficult to carry away specimens sufficient for determination at leisure. A blow-pipe, too, is of no use to any one unacquainted with the method of employing it, though this is easy to acquire.*

* There are plenty of good works on the use of the blow-pipe. The best are by Plattner and Scheerer, of both of which English translations have been published. Of Von Kobell's tables for the determination of minerals, several translations have appeared.

To form a rough idea of the value of iron ore, see whether it is heavy; to form some notion of the quality of coal, pile up a heap and set fire to it. If it does not burn freely, the prospects of the coal being useful are small. It may be anthracitic, and very valuable with proper appliances; but anthracite is not of the same general utility as bituminous coal. Good coal should burn freely, with more or less flame, and should leave but little ash, and it is preferable that the ash should be white, not red, as the latter colour is often due to the presence of pyrites, a deleterious ingredient.

Gold and gems have, as is well known, been procured in considerable quantities from the sands of rivers and alluvial deposits. The deposits known to the natives of any country are often of small value, and the rude methods of washing prevalent in so many lands suffice to afford a fair idea of the wealth or poverty of the sand washed. Gold and, wherever it is found, platinum occur in grains and nuggets, easily recognised by their colour and by their being malleable; but gems, such as diamond, ruby, sapphire, are not so easy to tell from less valuable minerals. They may be recognised by their crystalline form and hardness. A diamond is usually found in some modification of an octahedron, and the crystalline facets are often curved; rubies and sapphires are really differently coloured varieties of the same mineral and occur, when crystalline, in six-sided pyramids or some modification. A diamond is the hardest of known substances; nothing will scratch it, and it will scratch all other minerals. Sapphire will scratch everything except diamond.

In collecting fossils, it is useless to take many specimens of one kind, unless carriage is exceptionally plentiful. Two or three good examples of each kind are usually sufficient, but as many kinds as possible should be collected. Great care is necessary that all the specimens from one bed be kept distinct from those from another stratum, even if the bed be thin and the fossils in the two beds chiefly the same species. If there is a series of beds, one above the other, all containing fossils, measure the thickness roughly, draw a sketch-section in your note-book, apply letters or numbers to each bed in succession on the sketch, and label the fossils from that bed with the same letter or number.

Remains of Vertebrata, especially of mammals, birds and reptiles, are of great interest; but it is useless to collect fragments of bones without

terminations. Skulls are much more important than other bones, and even single teeth are well worth collecting. After skulls, vertebræ are the most useful parts of the skeleton, then the limb bones. If complete skeletons are found, they are usually well worth some trouble in transporting. If fossil bones are found abundantly in any locality, and the traveller has no sufficient means of transport, he will do well to carry away a few skulls or even teeth and carefully note the locality for the benefit of future geologists and explorers. The soil of limestone caverns, and especially the more or less consolidated loam, rubble, clay, or sand beneath the flooring of stalagmite, if it can be examined, should always be searched for bones, and also for indications of man or his works.

The foregoing remarks are intended for all travellers, especially for those who have paid little or no attention to geology. It would be far beyond the object of the present notes to attempt to give instruction in the methods of geological observation; all who wish to know more fully what questions are especially worthy of attention, should consult the article on Geology by the late Dr. Charles Darwin and Professor J. Phillips in the 'Admiralty Manual of Scientific Enquiry.' But a few hints may be usefully added here for those who have already some knowledge of geology, who do not require to have such terms as dip, strike, fault, or denudation explained to them, and who are sufficiently conversant with geological phenomena to be able to distinguish sedimentary from volcanic, and metamorphic from unaltered rocks, and to recognise granite, gneiss, schist, basalt, trachyte, slate, limestone, sandstone, shale, &c., in the field. Assuming then that a traveller with some knowledge of field geology is making a journey through a tract of the earth's surface, the geology of which is unknown, what will be the best method of procedure and the principal points to which he should direct his attention?

On the whole, the most useful record of a journey, whether intended for publication or merely as a memorandum, is a sketch geological map of the route followed, with the dips and strikes of the rocks and approximate boundaries to the formations, supplemented by notes and sketch-sections. Where, as is commonly the case in mountain-chains, and frequently in less elevated portions of the country, the rocks are much disturbed, and especially if the number of systems exposed is large and the changes frequent, no traveller can expect to do more than gain a very rough and general idea of the succession of beds in detail and of the structure; but by making excursions in various directions, whenever a

halt is practicable, by searching for fossils as a guide to the age and for the identification of beds with each other, and by carefully noting the general dip and strike of the more conspicuous beds, it is often possible, especially if an opportunity occurs of retracing the road followed, or of traversing a parallel route, to make out the structure of a country that at first appears hopelessly intricate. Dense forest is perhaps the worst obstacle to geological exploration; snow is another, though not quite so serious a disadvantage. It is always a good plan to climb commanding peaks; the general direction of beds, obscure from the lower ground, not unfrequently becomes much clearer when they are seen from above.

In level and undulating regions, on the other hand, it frequently happens that enormous tracts of country are occupied by the same formation, and if the rocks are soft, and especially if they are horizontal, or nearly so, little, if any, rock is to be seen in place. In this case watercourses should be searched for sections, and the pebbles found in the stream-beds examined, care being taken not to mistake transported pebbles derived from overlying alluvium or drift for fragments of the underlying rock. Where the same formation prevails over large tracts, it is usually easy, by examining the stones brought down by a stream, to learn whether any other beds occur. It is astonishing how even a small outcrop at a remote spot in the water-shed will almost always yield a few fragments that can be detected by walking two or three hundred yards up the stream-bed.

Not unfrequently different rocks support different vegetation, and by noting the forms that are peculiar, the constitution of hills at a considerable distance may be recognised. Thus some kinds of rock will be found to support evergreen, others deciduous trees, others grass, whilst a fourth kind may be distinguished by the poverty or want of vegetation. It is not well to trust too much to such indications, but they show which hills require examination and which do not. The form assumed by the outcrop of some hard beds is often characteristic, and may be recognised at a considerable distance.

One most important fact should never be forgotten; mineral character, whether of sedimentary or volcanic rocks, is absolutely worthless as a guide to the age of beds occurring in distant countries. The traveller should never be led to suppose, because a formation, whether sedimentary or volcanic, in a remote part of the world, is mineralogically and struc-

turally identical with another in Europe, or some country of which the geology is well known, that the two are of contemporaneous origin. The blunders that have been made from want of knowledge of this important caution are innumerable.

There are a few points of geological interest well worthy of the investigation of those who traverse unexplored, or partially explored, tracts of the earth's surface. Amongst these are the following:—

Mountain-Chains.—It is still a vexed question how mountain-chains have originated. Few, if any, geologists now believe that they were simply thrust up from below, all admit that, at least in the majority of cases, where great crumpling of the strata has taken place, there has been lateral movement of the earth's crust. But the causes, extent and date, of the lateral movements are still, to a great extent, matters of conjecture, and every additional series of observations bearing on the question is of importance. There are many mountain-chains of which very little is yet known. In each case good sections are required, drawn as nearly to scale as practicable, through the range from side to side, and including the rocks on the flanks. The nature and distribution of all volcanic and plutonic rocks, both in the range and throughout the neighbouring areas, are especially noteworthy, and also the relations of the later beds, if any, on the flanks of the mountains, to those constituting the range itself, the derivation of the materials of the former from the latter, and the relative amount of disturbance shown by the two, and by the different members of each.

Volcanoes and Volcanic Rocks.—It is almost needless to say that any additional information on the distribution of volcanic vents, recent or extinct, is of interest. In the case of extinct vents, the geological date of the last eruptions should be ascertained if practicable. This may sometimes be determined by finding organic remains or sedimentary beds of known age interstratified with the ashes or lava-streams near the base of the volcano.

Additional observations are needed as to the extent and age of those enormous masses of stratified volcanic rocks that occur in some parts of the earth, as in the western part of the Indian Peninsula, North-eastern Africa, the Western States of North America, and on a smaller scale in parts of Europe.

Coasts.—The subject of the erosion of coasts is now fairly understood,

and there is no doubt that the importance of this form of denudation was greatly overrated by many geological writers, who took their ideas of geological denudation generally from the phenomena observed in the islands, and on some of the coasts of Western Europe. Still, wherever cliffs occur, they afford good sections, and deserve examination. One question will usually present itself to almost every geological observer, and that is, whether any coast he may be landing upon affords evidence of elevation or depression. In the former case, beds of rolled pebbles or of marine shells, similar to those now living on the shore, may be found at some elevation above high-water mark. Very often the commonest molluscs in raised beds are the kinds occurring in estuaries, which are different from those inhabiting an open coast. Caution is necessary, however, that heaps of shells made by man, or isolated specimens transported by animals (birds or hermit-crabs), or by the wind, be not mistaken for evidence of raised beds. If the shore is steep, terraces on the hill-sides may mark the levels at which the sea remained in past times, but some care is necessary not to mistake outcrops of hard beds for terraces. If dead shells of species of mollusca, only living in salt-water estuaries, are found in places now beyond the influence of the tide, it is a reasonable inference that elevation has taken place.

The evidence of depression, on the other hand, unless there are buildings or trees partly sunk in the water, is much less readily obtained, and neither trees nor buildings are available as evidence, unless the depression is of comparatively recent date. The best proof is the form of the coast. If in tropical and sub-tropical countries deep inlets of moderate breadth occur, with numerous branches, a little examination will frequently show whether such inlets are valleys of subaërial erosion, as they not unfrequently are, that have been depressed below the sea. A good and familiar example of such a depressed valley is to be found at Milford Haven in South Wales. In higher latitudes, care must be taken not to mistake valleys excavated by glaciers, such as the friths and lochs of Scotland, and the fiords of Norway, for valleys of subaërial erosion that have undergone subsidence.

Rivers and River-Plains.—At the present time a question of much interest is the antiquity of existing land-areas, and some light may be thrown upon this, if the relations of existing river-basins to those of past times can be determined. If a stream cuts its way through a high range,

it is probable that the stream is of greater antiquity than the range, and either once ran at an elevation higher than the crest of the ridge now traversed, or else has cut its way through the range gradually during the slow elevation of the latter. Where a river traverses a great alluvial plain, it may fairly be inferred that a long range of time has been occupied in the accumulation of the deposits to form the plain; but it remains to be seen whether those deposits are not partly marine or lacustrine. If upheaval has taken place over any portion of the plain, or if the river has cut its bed deeper, sections may be exposed, and these should always be examined for fossil remains. Bones of extinct animals are not unfrequently found in such deposits.

Lakes.—The mode of origin of lakes is always a subject of considerable geological interest. Some lakes occupy areas of depression, or valleys of erosion, the drainage from which has been stopped by local elevation, whilst very many, and amongst them some of great size and depth, occur in regions that have undergone denudation from ice; and it is still a moot point how far the larger of these lakes are due to partial changes in the elevation of the country, many excellent observers having adopted, while others dispute the views of Sir A. Ramsay, who believes all these hollows to have been scooped out by ice moving over the surface in the form of a glacier or of an ice sheet. Of the smaller lakes, some are dammed up by landslips, some by glacial moraines, and a few occupy volcanic craters.

Evidence of Glacial Action.—Closely connected with the subject of lakes is that of glacial evidence generally. There is probably no geological question which has produced more speculation of late years than the inquiry into the traces of a comparatively recent cold period in the earth's history. Closely connected with this inquiry is the equally important question as to the former occurrence of similar glacial epochs at regular or irregular intervals of geological time.

The evidence of the last glacial epoch may be traced in two ways—by the form of the surface, which has been modified by the action of ice, and by changes that have taken place in the fauna and flora of the country in consequence of the alteration in the climate. The effects of an ice-sheet, like that now occurring in Greenland, if such formerly existed in comparatively low latitudes, must have been to round off, score and polish the rocks of the country in a peculiar manner, easily recog-

nised by those familiar with glaciated areas.* Glaciers, properly so called, are confined to more mountainous countries, and the valleys formerly occupied by them retain more or less the form of the letter U instead of taking the shape of the letter V, as they do when they have been cut out by running water. The sides of the valley, when modified by a glacier, have a tendency to assume the form of slopes unbroken by ravines, and with all ridges planed away or rounded, whilst in ordinary valleys of erosion, the sides consist of a series of side valleys or ravines, divided from each other by sharp ridges running down to the main valley. Large and small masses of rock, preserving to a considerable extent an angular form, but frequently polished and grooved by being ground against the sides or bottom of the valley, are carried down by the ice, and either left behind, perched up high on the slopes of the valley, or accumulated in a vast heap known as a terminal moraine, at the spot where the ice has terminated. The nature of the rock will usually show whether the fragments on the side of a hill or at the bottom of a valley are derived from the higher parts of the drainage area, or whether they have merely fallen down from the neighbouring slopes. In the latter case, they may be due to landslips; in the former, their shape and the erosion they have undergone will aid in showing whether they have been transported by water or ice.

The surfaces that have been modified by earlier glacial epochs must in general have been long since removed by other denuding agencies, though in one case in Scotland, and in another in India, glaciated surfaces of vast geological antiquity are believed to have been discovered. The most important evidence of former ice action must consist in the occurrence, embedded in fine sediment, of large boulders, occasionally preserving marks of polish and striation, and usually, though not always, angular.

It is well to search in all mountain ranges for traces of glacial action. In many mountain-chains, even in comparatively low latitudes, proofs have been found of the existence of glaciers, at a much lower level than at present, dating from a comparatively recent geological period, whilst in other mountain regions none have been recognised. The ques-

* Care should be taken that the peculiar scoring and grooving of rock surfaces produced by the action of sand transported by the wind be not mistaken for glacial evidence.

tion also whether glacial action has been contemporaneous in the two hemispheres is of the greatest importance, and the evidence hitherto adduced is of a very conflicting character.

Deserts.—The great sandy or salt plains, with a more or less barren surface, that occupy a large area in the interior of several continents, have only of late years received due attention from geologists. A great thickness of deposits must occur in many of these vast, nearly level, tracts, for the underlying rocks are often completely concealed over immense areas. The investigation of the deposits is frequently a matter of great difficulty for want of sections; but, where practicable, a careful examination should be made, and exact descriptions of the formations exposed recorded. Some, at all events, of these beds appear to be entirely derived from the air, and consist of the decomposed surfaces of rocks and the sand and silt from stream deposits, carried up by wind and then redeposited on the surface of the country. Such deposits are very fine, formed of well-rounded grains, and, as a rule, destitute of stratification. The geologist who has especially described these formations, Baron F. von Richthofen, in his work on China, attributes to the loess of the Rhine and Danube valleys a similar origin. It is usual to find beds due to water-action, rain-wash and stream-deposits, interstratified with the subaërial accumulations. Further observations on these formations are desirable. The occurrence of blown sands, the origin of these accumulations, and the peculiar ridges they assume, usually at right angles, but in some remarkable cases parallel to the prevailing winds, are questions deserving of additional elucidation.

Early History of Man in Tropical Climates.—Very little has been discovered as to the races of men formerly inhabiting tropical regions. It is evident that a race unacquainted with fire could only have existed in a climate where suitable food was procurable throughout the year, and this must have been in a region possessing a climate like that found in parts of the tropics at the present day. It is possible that an investigation of the cave deposits in the tropics may throw some light on this subject. "Kitchen middens," as they are termed—the mounds that have once been the refuse-heaps of human habitations—are also worthy of careful examination.

IV.

NATURAL HISTORY.

By H. W. BATES, F.R.S., Assistant Secretary, R.G.S.

IN the present state of biological science, travellers who intend to devote themselves specially to the zoological or botanical investigation of new or little-known countries, require to be trained for the work beforehand, and will be necessarily well-informed as to methods and appliances. It is not for them that these 'Hints' are drawn up, but for general travellers and explorers, who, whilst engaged chiefly in survey, wish to know how best to profit by their opportunities of benefiting science by collecting new or rare species, and how to preserve and safely transmit their specimens. The observations refer only to explorations by land.

*Outfit.**—A double-barrel gun; for large aquatic birds, &c., a breech-loader to be preferred, and wire cartridges. For Central Africa, and regions where large pachyderms are found, a more powerful weapon is also required. Mr. Thomson took with him on his recent expedition a breech-loading 8-gauge elephant gun, double-barrel, smooth bore, and weighing about 11 lbs., and fitted with a thick Silver's patent anti-recoil heel-plate; with its leather cover, powder-measure, bullet-fixer and mould, &c.

If percussion-cap guns are used, fine powder in canisters, and fine shot, must be taken from England; coarse powder and shot can be had in any part. A good supply of the best caps and a few spare nipples.

Arsenical soap in tin boxes; brushes of different sizes for applying the same: a small supply of carbolic acid, cyanide of potassium or insect "killing bottles." Benzine. Thin cotton cloths, and strong thread. Bottle of rangoon oil.

Scalpels, scissors (including a pair of short-bladed ones), needles and

* Implements, &c., for collecting and preserving birds, insects, &c., can be obtained of Messrs. Watkins and Doncaster, Strand, W.C.; for the larger animals, as well as other articles of general travelling outfit, of Messrs. Silver and Co., Cornhill.

thread. Long straight forceps (similar in form to curling-irons) are very useful for inserting cotton into the necks of bird-skins, to avoid stretching them; two or three sizes. Bone nippers and screw-driver.

A few small traps, with which to capture small (mostly nocturnal) mammals. The "Excelsior" and "Premier" traps, always set and baited, are recommended, as they capture small mammals without injuring them. For spring traps the "American wire-traps" should be preferred, as they are very light and of different sizes, and a large number weigh little and occupy small space.

Stone jars for reptiles and fishes in spirit; to fit four in a box, with wooden partitions. If animals in spirit are to be collected largely, the tin collecting-case described further on, and a supply of sheet-tin or zinc, with a pair of soldering-irons and a sufficient quantity of soft solder, must be taken instead of, or in addition to, stone jars. Cylindrical cases can then be made of any size required. By means of the soldering apparatus also empty powder-canisters, and other tin vessels, can be easily converted into receptacles for specimens.

A short landing-net for water-molluscs and other small aquatic animals. A stout hoop-net (the stick, 4 or 5 feet long, crossing the hoop) for capturing insects on the wing and for sweeping herbage for Coleoptera, &c.; a few yards of silk gauze for nets in reserve.

A few dozen of strong and broad-mouthed bottles for collecting Coleoptera, and other hard-bodied insects. A supply of triangular paper envelopes for Lepidoptera, &c. Boxes of light wood of various sizes (about the size of cigar-boxes for insects) for storing and packing specimens. Tin boxes may be used in very damp climates, provided the contents are well dried before storing; and the general outfit of an expedition may be much lightened by having all the provisions, and other consumable articles, packed in tin cases, and in boxes and jars of such forms as may render them available for containing specimens.

In humid tropical countries, where the ubiquitous ants are likely to destroy specimens before they are ready to be packed away, drying-cages, suspended from the roof of a hut or tent, are absolutely necessary. These can be readily made from old packing-cases, but a few square feet of wire gauze must be provided for the back and front of the cages, and the cord by which they are suspended must be threaded through a small calabash containing oil, to prevent ants from descending from the roof. The

cages may be so arranged as to take to pieces and put together again readily; one, for birds, should be about 2 feet 6 inches long by 1 foot 6 inches high and 1 foot broad; the other, for insects and other small specimens, may be about one-third less. They should have folding doors in front, with panels of wire gauze, and the backs wholly of the latter material: the sides fitted with racks to hold six or eight plain shelves, which, in the smaller cage, should be covered with cork, or any soft wood that may be obtained in tropical countries. A strong ring fixed in the top of the cage, with a cord having a hook attached at the end by which to hang it in an airy place, will keep the contained specimens out of harm's way until they are quite dry, when they may be stowed away in their close-fitting boxes.

A few yards of india-rubber waterproof sheeting, as temporary covering to collections in wet weather, or in crossing rivers.

A set of carpenter's tools, for making boxes and packing-cases.

Where and what to collect.—The countries which are now the least known with regard to their natural history, are New Guinea and the large islands to the east of it, Northern Australia, the interior of Borneo, Thibet, Indo-China, and other parts of Central Asia, Equatorial Africa, and the eastern side of the Andes, from east of Bogota to the south of Bolivia. A special interest attaches to the indigenous productions of oceanic islands, *i.e.* islands separated by a deep sea from any large tract of land. Those who have opportunities would not fail to make interesting discoveries by collecting specimens of the smaller animals (insects, molluscs, &c.) and plants in these isolated localities. Both in continental countries and on islands the truly indigenous species will have to be sought for on hills or in the remote parts, where they are more likely to have escaped extermination by settlers and the domestic animals introduced by them. In most of the better-known countries the botany has been better investigated than the zoology, and in all there still remains much to be done in ascertaining the exact station, and the range, both vertical and horizontal, of known species of animals and plants. This leads us to one point, which cannot be too strongly insisted on, namely, that some effective means should be adopted by the traveller to record the exact locality of the specimens he collects. With regard to the larger dried animals this may be done by written tickets attached to the specimens; if insects are pinned, a ticket may be fixed on the pins; and if packed unpinned in boxes, all taken in one place should be laid together

and a common locality label placed with them. The first two or three letters of the locality is perhaps the readiest plan; and when all the specimens taken at one place can be put into a separate box one memorandum upon the box itself will be sufficient. Reptiles and fishes should have small parchment tickets attached to them before they are placed in spirits. In mountainous countries the approximate height above the sea, should be noted.

A traveller may be puzzled, in the midst of the profusion of animal and vegetable forms which he sees around him, to know what to secure and what to leave. Books can be of little service to him on a journey, and he had better at once abandon all idea of encumbering himself with them. A few days' study at the principal museums before he starts on his voyage may teach him a great deal, and the cultivation of a habit of close observation and minute comparison of the specimens he obtains will teach him a great deal more. As a general rule, all species which he may meet with for the first time far in the interior should be preferred to those common near the civilised parts, and he should bear in mind that the few handsome kinds which attract the attention of the natives and are offered for sale to strangers are almost sure to be species well known in European museums. He should strive to obtain as much variety as possible, and not fill his boxes and jars with quantities of specimens of one or a few species. But as some of the rarest and most interesting species have great resemblance to others which may be more common, he should avail himself of every opportunity of comparing the objects side by side. In most countries, as before remarked, the truly indigenous, and often the rarest, species are to be found only in the mountains at considerable elevation and in the primitive forests, the products of cultivated districts being nearly all widely distributed and well known. In botany a traveller, if obliged to restrict his collecting, might confine himself to those plants which are remarkable for their economical uses; always taking care to identify the flowers of the tree or shrub whose root, bark, leaves, wood, &c., are used by the natives, and preserving a few specimens of them. But if he has the good fortune to ascend any high mountain not previously explored, he should make as general a collection of the flowering plants as possible, at the higher elevations. The same may be said of insects found on mountains, where they occur in great diversity—on the shady and cold sides rather than on the sunny slopes—under stones, and about the roots of herbage, especially near springs, on shrubs

and low trees, and so forth; for upon a knowledge of the plants and insects of mountain ranges depend many curious questions regarding the geographical distribution of forms over the earth. In reptiles, the smaller *Batrachia* (frogs, salamanders, &c.) should not be neglected, especially the extremely numerous family of tree-frogs; lizards may be caught generally with the insect sweeping-net; the arboreal, or rock-haunting species seen out of reach, and the swift-running forms that inhabit sandy plains may be brought down with a charge of dust-shot. Snakes should be taken without injuring the head, which is the most important part of the body: a cleft stick may be used in securing them by the neck, or they may be shot, and on reaching camp they may be dropped into the jars of spirits. As large a collection as possible should be made of the smaller fishes and tortoises of lakes and rivers.

Mammals and Birds.—An ordinary geographical expedition will hardly have the means at its disposal for bringing home many specimens of the larger animals. But some species in regions visited only by adventurous explorers are still desiderata in the large museums of Europe; and additional specimens of all genera of which there are numerous closely-allied species (*e. g.* rhinoceros, antelope, equus, &c.), and all the small nocturnal mammals would be welcome to zoologists. If only portions can be obtained, skulls are to be preferred. In humid tropical regions entire skins cannot be dried in time to prevent decay, and it is necessary to place them, rolled up in small compass, in spirits. The smaller birds shot on an excursion should be carried to camp in the game-bag, folded in paper, the wounds, mouth and anus being first plugged with cotton. Powdered calcined gypsum will here be found very useful in absorbing blood from feathers, on account of the facility with which it can be afterwards cleared from the specimens. Dull-coloured and small birds are most likely to be new or interesting.

Immediately after killing a small mammal or bird, make a note of the colour of its eyes and soft parts, and, if time admits, of the dimensions of its trunk and limbs. It facilitates skinning of birds to break, before commencing, the first bone of the wings a short distance above the joint, which causes the members to lie open when the specimen is laid on its back on the skinning-board. The animal should be laid with its tail towards the right hand of the operator, and the incision made from the breast-bone, nearly to the anus. A blunt wooden style is useful in commencing the operation of separating the skin from the flesh. When the leg is reached,

cut through the knee-joint and then clear the flesh from the shank as far as can be done, afterwards washing the bone slightly with arsenical soap, winding a thin strip of cotton round it, and returning it to the skin. Repeat the process with the other leg, and then sever, with the broad-bladed scissors, the spine above the root of the tail. By carefully cutting into the flesh from above, the spine is finally severed without injuring the skin of the back, and it is then easy to continue the skinning up to the wings, when the bones are cut through at the place where they had previously been broken, and the body finished as far as the commencement of the skull. A small piece of the skull is now cut away, together with the neck and body, and the brains and eyes scooped out, the inside washed with the soap, and clean cotton filled in, the eyes especially being made plump. In large-headed parrots, woodpeckers, and some other birds, the head cannot thus be cleaned; an incision has, therefore, to be made either on one side or on the top of the head, through which the back of the skull can be thrust a little away and then cleansed, the incision being afterwards closed by two or three stitches. The bones then remaining in each wing must be cleaned, which must be done without loosening the quill-feathers. It is much better to take out the flesh by making an incision on the outside of the skin along the flesh on the inner side of the wing. The inside of the skin must now be washed with the soap, and a neck of cotton (not too thick) inserted by means of the long narrow forceps, taking care to fix the end well inside the skull, and withdrawing the empty forceps without stretching the skin of the neck, and thus distorting the shape of the bird. Skins need not be filled up with cotton or any other material, but laid, with the feathers smoothed down, on the boards of the drying-cage until they are ready to be packed in boxes. Each skin should be kept in a separate roll of brown paper, and store boxes should be lined with brown paper, which is avoided by insects. In very humid climates, like that of Tropical America, oxide of arsenic in powder is preferable to arsenical soap, on account of the skins drying quicker; but it cannot be recommended to the general traveller, owing to the danger attending its use.*

In mammals the tail offers some difficulty to a beginner. To skin it,

* For further information about collecting birds, formula for making arsenical soap, &c., we may refer the traveller to Hume's 'Collector's Vade Mecum' (Quaritch, London. Price 2s.)

the root (after severing it from the spine) should be secured by a piece of strong twine, which should then be attached to a nail or beam; with two pieces of flat wood (one placed on each side of the naked root), held firmly by the hand and pulled downwards, the skin is made rapidly to give way generally to the tip. The tails of some animals, however, can be skinned only by incisions made down the middle from the outside. The larger mammal skins may be inverted, and, after washing with the soap, dried in the sun: as before remarked, it is often necessary to roll them up and preserve in spirit.

The skins of small mammals and birds, after they are *quite* dry, may be packed in boxes, which must be previously well washed inside with arsenical soap, lined with paper, and again covered with a coating of the soap and well dried in the sun. This is the very best means of securing the specimens from the attacks of noxious insects, which often, to the great disgust of the traveller, destroy what he has taken much pains to procure. When wood is scarce, as in the interior of Africa, boxes may be made of the skins of antelopes or other large animals by stretching them, when newly stripped from the animal, over a square framework of sticks, and sewing up the edges: after being dried in the sun they make excellent packing-cases.

Preserving Mammals, &c., in Alcohol.—In the interests of science the preservation, in alcohol, of mammals and birds, as well as of reptiles, fishes and crustacea, is to be preferred, and the traveller is earnestly recommended to adopt this plan, especially with regard to the smaller specimens, dried skins of which are almost useless for scientific purposes. On this subject Dr. G. E. Dobson sends us the following 'Hints':—

The general collecting-case should be made of strong block tin, rectangular in form, about 2 feet \times 1 foot \times 1 foot 8 inches in height, having in the top a circular aperture from 6 to 8 inches in diameter, closed by a well-fitting brass screw cap, the flange of which is made air-tight by a well-greased leather collar. This should fit accurately into a similarly shaped box of inch boards, having a simple flat lid (not projecting beyond the sides), secured by eight long screws, and provided with a strong iron handle. This case should be filled with the strongest methylated spirit procurable (in foreign countries over-proof rum, brandy, or arrack will suit equally well). If circumstances admit, two or more such cases should be taken, or four wide-mouthed earthenware jars placed in a

square wooden case and separated by light wooden partitions, having their mouths closed by well-fitting bungs tied down with bladder and skin. On arrival at the collecting station one of the jars should be half

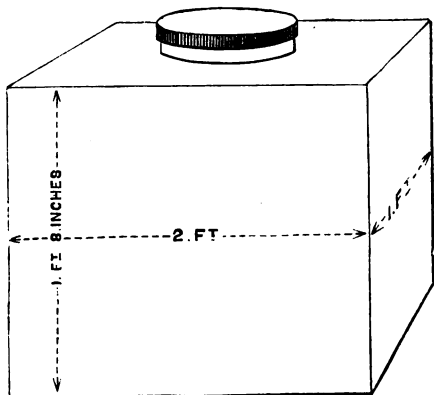

filled with spirit from the tin case. Into this each specimen, as it is obtained, having a long slit made in the side of the abdomen, should be put, and allowed to remain 24 hours before being transferred to the general collecting case. When the latter can hold no more, the specimens should be removed one by one and packed in the moist state in the other wide-mouthed jars, one above the other, like herrings in a cask, each rolled in a piece of thin cotton cloth, in which a label, having the locality and date written in pencil, is placed. When the jar has been thus filled to the mouth a glass or two of the strong spirit (kept in reserve) should be poured in so as to fill up interstices, but not to appear on the surface, which should be covered with a thick layer of cotton wool. A few drops of carbolic acid, if the spirit be weak, will greatly aid its preserving powers. The bung should then be replaced, secured round the margin outside with a mixture of tallow and wax, and tied down securely with bladder or skin, and the name of the collector and district written legibly outside. The jar is now ready for transmission to any distance, for specimens thus treated will keep good in the vapour alone of strong spirit

for months. Other jars may be filled in like manner, and, finally, the general collecting-case. Incisions should invariably be made in the *sides* (not in the centre line) of all animals, so as to allow the spirit to enter, and no part of the intestines should be removed. In the case of *toroises* the opening may be made in the soft parts round the thighs; if this be not done the body soon becomes distended with gases. *Frogs* should always be first placed in weak spirit, and after soaking for one or two days, be removed to strong alcohol. *Crabs* should be rolled up alive in thin cotton cloths, secured by thread tied round; they are then readily killed by immersion in alcohol; if this be not done they lose many of their limbs in their dying struggles.

Preparation of Skeletons of Animals.—In many cases it will be found impossible to preserve the whole animal, especially if of large size, but it may advantageously be converted into a skeleton by attention to the following directions by Prof. W. H. Flower, F.R.S. :—

If the animal is of small size—say not larger than a fox—take off the skin, except from the feet below the wrist and ankle joints. If it is intended to preserve the skin as a zoological specimen as well as the skeleton, the bones of the feet should all be left in the skin; they can be easily extracted afterwards, and will be preserved much more safely in their natural covering. Remove all the contents of the abdominal and thoracic cavities; also the larynx, gullet, and tongue. In doing this be careful to leave attached to the base of the skull the chain of bones which supports the root of the tongue. These may either be left in connection with the skull, or cleaned separately and tied to the skeleton. Then clear away, with the aid of a knife, as much as possible of the flesh from the head, body, and limbs, without cutting or scraping the bones, or separating them from each other. At any intervals that may be necessary during this process it will be desirable, if practicable, to leave the body in water, so as to wash away as much of the blood as possible from the bones, and a few days' soaking in water frequently changed will be an advantage.

The body, with all the bones held in connection by their ligaments, should then be hung up to dry in a place where there is a free current of air, and out of the way of attacks from animals of prey. Before they get hard the limbs may be folded by the side of the body in the most convenient position, or they may be detached and placed inside the trunk.

When thoroughly dry the skeletons may be packed in boxes with any convenient light packing material between them. Each should be well wrapped in a separate piece of paper or canvas, as sometimes insects will attack the ligamentary structures and allow the bones to come apart.

If it can be avoided, skeletons should never be packed up as long as any moisture remains in them, as otherwise decomposition will go on in the still adhering soft parts, causing an unpleasant smell.

If the animal is of larger size, it will be most convenient to take it partially to pieces before or during the cleaning. The head may be separated from the neck, the vertebral column divided into two or more pieces, and the limbs detached from the trunk; but in no case should the small bones of the feet be separated from one another. The parts should then be treated as above described, and all packed together in a canvas bag.

In the cetacea (porpoises, &c.), look for two small bones suspended in the flesh, just below the vertebral column, at the junction of the lumbar and caudal regions (marked externally by the anal aperture). They are the only rudiments of a pelvis, and should always be preserved with the skeleton.

If there is no opportunity of preserving and transporting entire skeletons, the skulls alone may be kept. They should be treated as above described, picked nearly clean, the brain being scooped out through the *foramen magnum*, soaked for a few days in water, and dried.

Every specimen should be carefully labelled with the scientific or popular name of the animal, if known, and at all events, the sex, the exact locality at which it was procured, and the date.

For the purpose of making entire skeletons, select, if possible, adult animals; but the skulls of animals of all ages may be advantageously collected.

Collectors of skins should always leave the skull intact. The common practice of destroying its hinder part for the purpose of getting out the brain is unnecessary, and greatly diminishes the value of the specimens.

Reptiles and Fishes.—The following 'Hints' have been communicated by Mr. Osbert Salvin, who collected these animals most successfully in Guatemala:—

Almost any spirit will answer for this purpose, its fitness consisting in the amount of alcohol contained in it. In all cases it is best to procure

the strongest possible, being less bulky, and water can always be obtained to reduce the strength to the requisite amount. When the spirit sold retail by the natives is not sufficiently strong, by visiting the distillery the traveller can often obtain the first runnings (the strongest) of the still, which will be stronger than he requires undiluted. The spirit used should be reduced to about proof, and the traveller should always be provided with an alcoholometer. If this is not at hand, a little practice will enable him to ascertain the strength of the spirit from the rapidity with which the bubbles break when rising to the surface of a small quantity shaken in a bottle. When the spirit has been used this test is of no value. When reptiles or fish are first immersed, it will be found that the spirit becomes rapidly weaker. Large specimens absorb the alcohol very speedily. The rapidity with which this absorption takes place should be carefully watched, and in warm climates the liquid tested at least every twelve hours, and fresh spirit added to restore it to its original strength. In colder climates it is not requisite to watch so closely, but practice will show what attention is necessary. It will be found that absorption of alcohol will be about proportionate to the rate of decomposition. Spirit should not be used too strong, as its effect is to contract the outer surface, and thus, closing the pores, prevent the alcohol from penetrating through to the inner parts of the specimen. *The principal point, then, is to watch that the strength of the spirit does not get below a certain point while the specimen is absorbing alcohol when first put in.* It will be found that after two or three days the spirit retains its strength: when this is the case, the specimen will be perfectly preserved. Spirit should not be thrown away, no matter how often used, so long as the traveller has a reserve of sufficient strength to bring it back to its requisite strength.

In selecting specimens for immersion, regard must be had to the means at the traveller's disposal. Fish up to 9 inches long may be placed in spirit, with simply a slit cut to allow the spirit to enter to the entrails. With larger specimens, it is better to pass a long knife outside the ribs, so as to separate the muscles on each side of the vertebræ. It is also as well to remove as much food from the entrails as possible, taking care to leave all these in. The larger specimens can be skinned, leaving, however, the intestines in, and simply removing the flesh. Very large specimens preserved in this way absorb very little spirit. All half-digested food should be removed from snakes and animals. In spite of these precautions,

specimens will often appear to be decomposing; but, by more constant attention to re-strengthening the spirit, they will, in most cases, be preserved.

A case (copper is the best), with a top that can be unscrewed and refixed easily, should always be carried as a receptacle. The opening should be large enough to allow the hand to be inserted; this is to hold freshly-caught specimens. When they have become preserved, they can all be removed and soldered up in tin or zinc boxes. Zinc is best, as it does not corrode so easily. The traveller will find it very convenient to take lessons in soldering, and so make his own boxes. If he takes them ready made, they had best be arranged so as to fit one into another before they are filled. When moving about, all specimens should be wrapped in calico or linen or other rags to prevent their rubbing one against the other. This should also be done to the specimens in the copper case when a move is necessary, as well as to those finally packed for transmission to Europe. These last should have all the interstices between the specimens filled in with cotton-wool or rags. If a leak should occur in a case, specimens thus packed will still be maintained moist, and will keep some time without much injury. Proof spirit should be used when the specimens are finally packed, but it is not necessary that it should be fresh.

*Land and Freshwater Mollusca.** By LIEUT.-COL. H. H. GODWIN-AUSTEN, F.R.S.—Always most abundant on limestone rocks. Search for under the larger stones lying about the ground, or under fallen trees and logs in the woods and forests. Will be generally found adhering to the surface of the stone or wood. Many species are often only 0·05 inch in length, so very close examination is necessary. In damp spots, generally in ravines with a northerly aspect, the dead leaves when damp with dew in the early morning may be turned over one by one, and the under surface examined for minute species, and larger species will be found very frequently on the surface of the ground below the layer of decaying vegetable matter. Tear off the bark of decaying trees also. In the drier parts of the country some species are only to be found among the roots of shrubs, and at considerable depth; by digging them out and shaking the earth on to paper, small shells may be found on close examination. At a dry place like

* Much of the information may be found in the 'Manual of the Mollusca,' by Weale, one of Weale's series. An admirable book in small form.

Aden, I should expect to find most of the land-shells alive in such a habitat. Look well in caves in limestone on the damp surface of the rock; some forms hide themselves under a coating of earthy matter. Search also on damp moss and rock near waterfalls.

Some species will be found high up on the bushes and trees. This is the habit of certain African forms especially; not so in India. A very good idea may at first be obtained of the land-shells of a country by the examination of the beds of the streams, either along the highest flood-line, or in the fine sand and mud where it collects in the bed; such land-shells will usually be old and bleached, but the living will not be far off.

The leaves and stems of water plants should be examined, and Confervæ taken out of the water and well washed in a basin; in this, and the mud of ponds and still rivers, many minute shells may be found.

The best way of preserving minute shells is to put them into glass tubes and use wool to stop them, it is better than cork. Capital collecting tubes can be made out of the smaller species of bamboo and the large grasses. A certain number of all species (at least a dozen) should be preserved in spirit for the sake of the anatomy. It is best to kill them first in water and then put them into the spirit; if this is not done they contract, so that it is impossible to form any idea of the form of the mantle and other parts, or they become so hard they are difficult to cut up.

A good method of keeping the small shells and slugs, especially in spirit, is to put them into a small tube with a label, plug with wool, and then place in a large jar, capable of holding three or four dozen such small tubes.

Other small shells, $\frac{1}{2}$ to $\frac{3}{4}$ of an inch in diameter, may be put into pill-boxes at once, for in a dry climate they very soon dry up. The very large animals may be removed by boiling them in water, but when time does not admit of attending to the cleaning of the shells, species such as unios may be put into empty soup-tins and then filled up with dry sand.

It is very important to make a few notes on the colour of the animal, attaching a number for reference on the box or in the tube, and the operculum, when present, should always be preserved.

With respect to slugs, note the surface of the mantle, and always the form of the extremity of the foot, whether pointed or provided with a mucous pore; and again the lobes of the mantle. Preserve in spirit as

above. Drawings from the living animal are invaluable, and should be made if possible. Very little is known of the Asiatic forms; they are of much interest, and have been very little collected.

Insects.—Many of the most local and interesting insects of a country are not to be found without a knowledge of their habits, and some are nocturnal. In wooded and mountainous countries, they must be searched for in dead wood, under logs, stones, fallen fruit, or moss, in folded leaves, on sandy river banks, and under shingle, about roots of herbage, in small dead vertebrated animals, &c., &c. The best way of forming a collection is to pin and set out the captures of each day before retiring to rest, and, after drying them, to store the specimens in air-tight corked-boxes. It is only thus that good museum specimens can be obtained, and the colours and fine hairy clothing preserved with which many species are furnished. But on a journey of exploration this is quite impracticable, and all travellers, including professional natural history collectors, now adopt more summary and compact methods; laying all the hard-bodied tribes in prepared sawdust, and folding all the delicate-winged species in small triangular paper envelopes. The former class, when captured, should be placed in broad-mouthed collecting bottles, containing a minute piece of cyanide of potassium, or in insect "killing bottles," which may be obtained at any taxidermist's, to kill them speedily, failing which, a twisted piece of rag should be placed in the bottles to prevent the specimens mutilating each other. On reaching camp the contents should be shaken out (into boiling water if not already killed), and then placed in boxes, between layers of large-grained or sifted and well-dried sawdust. The under side of the lid of the box should be moistened with carbolic acid, which will prevent the attacks of insects or moisture, but the sawdust itself should not be sprinkled with the acid, otherwise the colours of the contents will be tarnished. When the box is filled the lid may be lightly nailed down, and is then ready for transmission home. In collecting ants, it is necessary to open nests at the time of swarming, and secure the winged individuals, as well as the wingless workers of various sizes, of each species, the whole set being kept together and duly labelled. To facilitate this, the set may be lightly gummed on cardboard before placing them in sawdust. The more delicate-winged insects, such as butterflies, moths, dragon-flies, &c., should be killed by pressing the breast underneath the wings with thumb and forefinger (taking great care not to injure the wings), and then

dropping them with closed wings each into its paper envelope (a supply of which is to be taken in a satchel on every excursion); on reaching camp the envelopes, thus filled each with its specimen, should be packed, without pressing them too tightly, in boxes. Spiders and crustacea, land and fresh-water, may be collected in bottles containing spirit, where they may remain; but spirits should not be used for any other class of insects, except when intended for dissection of the internal parts, as alcohol distorts the forms and destroys the colours and pubescence.

Botanical Collecting. By J. BALL, F.R.S.—To obtain good specimens of dried plants in a condition serviceable to scientific men, the following are the chief points to be observed:—

1. *Selection of Specimens.*—The object is to give as much information as possible respecting the plant which it is intended to collect. Small plants not exceeding 16 inches in height should be collected *entire with the roots*. Slender plants of greater dimensions may be folded to the same length, and may often be collected entire. Of larger plants, shrubs, and trees, the object is to show as much as possible of the plant within the limit of the size of your drying paper. As an universal rule, both the flower and fruit (seed vessel) should if possible be preserved. Of those plants wherein the male and female flowers grow separately, both should, if possible, be collected.

2. *Conveyance of Specimens to Camp or Station.*—Tin boxes made for the purpose are generally used in Europe for carrying botanical specimens until they can be placed in the drying press. They answer sufficiently well in cool weather, but in hot countries specimens are often partly withered before they can be laid out; and a rough portfolio into which

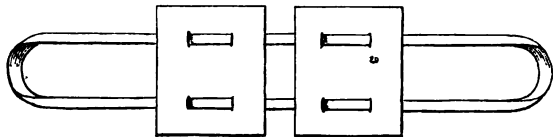

the plants can be put when (or soon after) they are gathered, is much to be preferred.

Such a portfolio is easily prepared with two sheets of millboard connected by an endless tape, so as to be easily slung over the shoulder;

between these about thirty or forty sheets (60 to 80 folds) of thin soft (more or less bibulous) paper may be carried and kept in place by a strap or piece of twine. With two such portfolios a traveller can carry as many plants as it is possible to collect with advantage in a day. As soon as possible after being gathered, the specimens may be laid roughly between the sheets of paper; except in the case of delicate flowers, no special care is needed, and no harm comes of two or three being put together.

3. *The Drying Press.*—The great object both to secure good specimens and to save labour and weight of paper, is to get the plants dried quickly; and for this one of the first conditions is to lose as little time as possible. When practicable, the specimens should always be put in the press on the same day on which they are gathered. The press should be made with two outer gratings of iron wire; the outer frame of strong wire, about a quarter of an inch in diameter—the size being that of the paper

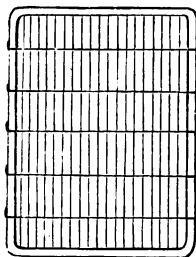

used. Between these the paper is laid. As to the choice of drying paper, the general rule is, that the coarser it is the better, provided it be quite or nearly quite free from size.

To enable the plants to dry quickly, the traveller should be provided with light wooden gratings of the same size as the drying paper. I think the size 18 inches \times 12 inches is quite large enough. The iron wire outer gratings may with advantage be a quarter of an inch longer and broader to save the edges of the wooden gratings.

These should be made of light laths fastened with a few nails (all the better if these are of copper), the interstices should be rather less than three-quarters of an inch, at all events not more. Their use is to allow the air to circulate through the pile of plants that are being dried. One

should be inserted at each interval of about two inches (counting the drying paper and the plants laid out for drying), and when this is done,

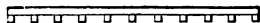

GRATING SEEN FROM THE EDGE.

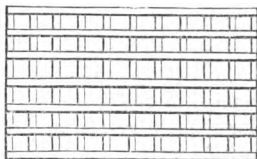

• GRATING SEEN FROM ABOVE.

the parcel may with advantage be exposed to the sun or placed near a fire, as the case may be. In dry warm climates, the majority of plants may be dried in the course of a few days, and fit to pack up, without any need of changing the drying paper in which they were originally placed; but in damp weather, and in regard to plants of thick fleshy foliage, it is usually necessary to change the paper more than once before the specimens are thoroughly dry.

The pile of paper, with plants between each five or six thicknesses of paper, and gratings at intervals of about two inches, should be squeezed between the outer (iron) gratings by means of two strong straps. Too much pressure is not desirable. For a pile ten or twelve inches thick, the parcel may be pulled nearly as tight as a moderate man can do it; but in proportion as the thickness is less, the pressure should be moderated.

Plants with fleshy leaves are very difficult to dry well. The best way is to dip them in water quite boiling for a minute or less, then to lay them between a few sheets of drying paper with slight pressure, merely to remove the exterior moisture, and then place them (when externally dry) in the drying press. Plants collected in rain should be treated in a similar way to remove outer moisture before it is attempted to dry them.

4. When once dry, plants may be packed away between paper of almost any kind. Old newspapers answer very well. The only precaution needed is to preserve them from insects.

The chief trouble in collecting plants is to get the paper already used thoroughly dry before it is again employed. The best resource in

dry climates is to stretch cords and hang these papers exposed to sun and air. Artificial heat must be resorted to in wet seasons, and the process is then slow and troublesome.

Fossils.—The collection of fossils and minerals (except, in the case of the discovery of new localities, for valuable metals) is not to be recommended to the traveller, if he is not a geologist. Fossils from an unexplored country are of little use unless the nature and order of superposition of the strata in which they are found can be at the same time investigated. In the cases, however, of recent alluvial strata or the supposed beds of ancient lakes, or deposits in caves, or raised sea-beaches containing shells or bones of vertebrate animals, the traveller will do well to bring away specimens if a good opportunity offers. If the plan of the expedition includes the collection of fossil remains, the traveller will, of course, provide himself with a proper geological outfit, and obtain the necessary instructions before leaving Europe. (*Vide* GEOLOGY, *ante*, p. 195.)

All collections made in tropical countries should be sent to Europe with the least possible delay, as they soon become deteriorated or spoilt unless great care be bestowed upon them. Dry skins of animals and birds may be packed in wooden cases well lined and padded with brown paper. Shells and skulls should be provided with abundance of elastic padding, such as cotton. Boxes containing pinned insects and crustacea should be packed in the middle of larger boxes and surrounded by an ample bed of hay or other light dry elastic material; unless this last point is carefully attended to, it will be doubtful whether such collections will sustain a voyage without more or less serious injury.

Observations of Habits, &c.—Travellers have excellent opportunities of observing the habits of animals in a state of nature, and these 'Hints' would be very deficient were not a few words said upon this subject. To know what to observe in the economy of animals is in itself an accomplishment which it would be unreasonable to expect the general traveller to possess, and without this he may bring home only insignificant details, contributing but little to our stock of real knowledge. One general rule, however, may be kept always present to the mind, and this is, that anything concerning animals which bears upon the relations of species to their

conditions of life is well worth observing and recording. Thus, it is important to note the various enemies which each species has to contend with, not only at one epoch in its life, but at every stage from birth to death, and at different seasons and in different localities. The way in which the existence of enemies limits the range of a species should also be noticed. The inorganic influences which inimically affect species, especially intermittently (such as the occurrence of disastrous seasons), and which are likely to operate in limiting their ranges, are also important subjects of inquiry. The migrations of animals, and especially any facts about the irruption of species into districts previously uninhabited by them, are well worth recording. The food of each species should be noticed, and if any change of customary food is observed, owing to the failure of the supply, it should be carefully recorded. The use in nature of any peculiar physical conformation of animals, the object of ornamentation, and so forth, should also be investigated whenever opportunity occurs. Any facts relating to the interbreeding in a state of nature of allied varieties, or the converse—that is, the antipathy to intercrossing of allied varieties—would be extremely interesting. In short, the traveller should bear in mind that facts having a philosophical bearing are much more important than mere anecdotes about animals.

To observe the actions of the larger animals, a telescope or opera-glass will be necessary. The traveller should bear in mind, if a microscope is needed in his journey, that by unscrewing the tubes of the telescope in which all the small glasses are contained, a compound microscope of considerable power is produced.

V.

ANTHROPOLOGY.

By E. B. TYLOR, D.C.L., F.R.S.

THE characters of men's bodies and minds being matters of common observation, Europeans not specially trained in anthropology, who have happened to be thrown among little-known tribes, often bring home valuable anthropological information. Though explorers traders and colonists have made their way into almost every corner of the earth, it is surprising to find how many new facts may still be noted down by any careful observer. If familiar with anthropological methods, he will, of course, observe more and better. The hints here given will serve to draw attention to interesting points which might otherwise be overlooked. Directions for such investigation, drawn up in much greater detail, will be found in the small British Association manual entitled: 'Notes and Queries on Anthropology' (Stanford, Charing Cross).

Physical Characters.—On first coming among an unfamiliar race, such as the Negroes, the traveller is apt to think them almost alike, till after a few days he learns to distinguish individuals more sharply. This first impression, however, has a value of its own, for what he vaguely perceived was the general type of the race, which he may afterwards gain a more perfect idea of by careful comparison. Among tribes who for many generations have led a simple uniform life and mixed little with strangers, the general likeness of build and feature is very close, as may be seen in a photograph of a party of Caribs or Andamaners, whose uniformity contrasts instructively with the individualised faces of a party of Europeans. The consequence is that the traveller among a rude people, if he has something of the artist's faculty of judging form, may select groups for photography which will fairly represent the type of a whole tribe or nation. While such portrait-groups are admirable for giving the general idea of a race, characteristic features belonging to it should be treated separately. For instance, to do justice to the Tartar eye or the Australian forehead the individual feature must be carefully sketched or photographed large.

How deceptive mere unmeasured impressions of size may be is shown by the well-known example of the Patagonians, who, though really only tall men (averaging 5 feet 11 inches), long had the reputation of a race of giants. Such measurements as any traveller can take with a measuring-tape and a three-foot rule with sliding square are good if taken with proper precautions. As the object of the anthropologist is to get a general idea of a race, it may be in some respects misleading to measure at random one or two individuals, who are perhaps not fair specimens. If only a few can be measured, they should be selected of ordinary average build, full-grown but not aged. What is much better is to measure a large number (20 to 50) of persons taken indiscriminately as they come, and to record the measurements of each with sex, age, name, locality, &c. Such a table can afterwards be so classified as to show not only the average or mean size, but the proportion of persons who vary more or less from that mean size; in fact, it represents on a small scale the distribution of stature, &c., in the whole people. Gigantic or dwarfish individuals, if not deformed, are interesting as showing to what extremes the race may run. The most ordinary measurements are height, girth round chest, fathom or length of outstretched arms, length of arm from shoulder and leg from hip, length of hand and foot. The traveller may find that such measuring of another race shows very different stature and girth from that of his own companions, who, if they are well-grown Europeans, may stand 5 feet 8 inches to 6 feet, and measure 34 to 36 inches round the chest. Beyond this, he will find that the relative proportions of parts of the body differ from those he is accustomed to. An example of this is seen by placing Europeans and negroes side by side, and noticing how much nearer the knee the negro's finger-tips will reach. It will be found that body measurement needs skill in taking the corresponding points, and in fact all but the simplest measures require some knowledge of anatomy. This is especially the case with skull measurements. There are instruments for taking the dimensions of the living head, and with care and practice the untrained observer may get at some of the more conspicuous, such as the relative length and width of the skull, as taken by hatters. This roughly indicates the marked difference between dolichocephalic or long-headed peoples, like the African negro, and brachycephalic or short-headed peoples, like the Talmuks and other Tartars. Attention should be paid also to the degree

of prognathism or projection of jaw, which, in some races, as the Australian, gives a "muzzle" unlike the English type. Where practicable, native skeletons, and especially skulls, should be sent home for accurate examination. How far this can be done depends much on the feeling of the people; for while some tribes do not object to the removal of bones, especially if not of their own kinsfolk, in other districts it is hardly safe to risk the displeasure of the natives at the removal of the dead—a feeling which is not only due to affection or respect, but even more to terror of the vengeance of the ghosts whose relics have been disturbed.

In describing complexion, such terms as "brown" or "olive," so often used without further definition in books of travel, are too inexact to be of use. Broca's scale of colours (see the Anthropological 'Notes and Queries') gives means of matching the tints of skin, hair, and eyes; if this is not forthcoming, the paint-box should be used to record them. Among rude tribes, the colour of the skin is often so masked by paint and dirt that the subject must be washed to see the real complexion. Hair is also an important race-mark, varying as it does in colour from flaxen to black, and also in the form and size of the hairs; for instance the American Indians' coarse straight hair seems almost like a horse's tail in comparison with the Bushman's hair with its natural frizz of tiny spirals. Locks of hair should therefore be collected. The traveller, however, will often find some difficulty in getting such specimens, from the objection prevalent in the uncivilised world of letting any part of the body, such as hair and nail-clippings, pass into strangers' hands lest they should be used to bewitch their former owner. Even in such countries as Italy, to ask for a lock of a peasant-girl's hair may lead to the anthropologist being suspected of wishing to practice love-charms on her.

Differences of temperament between nations are commonly to be noticed; for instance, in comparing the shy and grave Malays with the boisterous Africans. It is an interesting but difficult problem how far such differences are due to inherited race-character, and how far to such social influences as education and custom, and to the conditions of life being cheerful or depressing. Nor has it yet been determined how far emotions are differently expressed by different races, so that it is worth while to notice particularly if their smiling, laughing, frowning, weeping, blushing, &c., differ perceptibly from ours. The acuteness of the senses of sight hearing and smell, among wild peoples is often remarkable, but

this subject is one on which many accounts have been given which require sifting. The skill of savages in path-finding and tracking depends in great measure on this being one of their most necessary arts of life, to which they are trained from childhood, as, in an inferior degree, gypsies are with us. The native hunter or guide's methods of following the track of an animal or finding his own way home by slight signs, such as bent twigs, and keeping general direction through the forest by the sky and the sheltered sides of the trees, are very interesting, though when learnt they lose much of their marvellous appearance. The testing of the mental power of various races is an interesting research, for which good opportunities now and then occur. It is established that some races are inferior to others in volume and complexity of brain, Australians and Africans being in this respect below Europeans, and the question is to determine what differences of mind may correspond. Setting aside the contemptuous notions of uneducated Europeans as to the minds of "black-fellows" or "niggers," what is required is to compare the capacity of two races under similar circumstances. This is made difficult by the fact of different training. For instance, it would not be fair to compare the European sportsman's skill in woodcraft and hunting with that of the native hunter, who has done nothing else since childhood; while, on the other hand, the European, who has always lived among civilised people, owes to his education so much of his superior reasoning powers, that it is mostly impossible to get his mind into comparison with a savage's. One of the best tests is the progress made by native and European children in colonial or missionary schools, as to which it is commonly stated that children of African or American tribes learn as fast as or faster than European children up to about twelve, but then fall behind. Even here it is evident that other causes beside mental power may be at work, among them the discouragement of the native children when they become aware of their social inferiority. The subject is one of great importance, both scientifically and as bearing on practical government.

Both as a matter of anthropology and of practical politics, the suitability of particular races to particular climates is of great interest. Sometimes this depends on one race being free from a disease from which another suffers, as in the well-known immunity of negroes from yellow fever. Or it may be evident that tribes have become acclimatised, so as

to resist influences which are deadly to strangers; for instance, the Khonds flourish in the hills of Orissa, where not only Europeans but the Hindus of the plains sicken of the malaria in the unhealthy season. That such peculiarities of constitution are inherited and pass into the nature of the race, is one of the keys to the obscure problem of the origins of the various races of man as connected with their spread over the globe. As yet this problem has not passed much beyond the stage of collecting information, and no pains should be spared to get at facts thus bearing on the history and development of the human species. European medical men in districts inhabited by uncivilised races have often made important observations of this kind, which they are glad to communicate, though being occupied with professional work they do not follow them up. In all races there occur abnormal varieties, which should be observed with reference to their being hereditary, such as Albinos, whose dead-whiteness is due to absence of pigment from the skin. Even such tendencies as that to the occurrence of red hair where the ordinary hue is black, or to melanism or diseased darkening of the skin, are worth remark. It is essential to discover how far these descend from parents to children, which is not the case with such alterations as that of the Chinese feet, which, in spite of generations of cramping, continue of the natural shape in the children.

Language.—Before coming to actual language, remark may be made on the natural communication of all races carried on by pantomimic signs without spoken words. This is the “gesture-language” to which we are accustomed among the deaf-and-dumb, and which sometimes also comes into practical use between tribes ignorant of one another’s languages, as on the American prairies. It is so far the same in principle everywhere, that the explorer visiting a new tribe, having to make frequent use of signs to supplement his interpreter, or to eke out his own scanty knowledge of the native language, soon adapts himself to the particular signs in vogue. He will observe that, as to most common signs, such as asking for food or drink, or beckoning or warning off a stranger, he understands and is understood quite naturally. Signs which are puzzling at first sight will prove on examination to be intelligible. Some are imitative gestures cut short to save trouble, or they may have a meaning which was once evident, like the American Indian sign for dog, made by trailing two forked fingers, which does not show its meaning now, but

did so in past times, when one principal occupation of the dog was to trail a pair of tent-poles fastened on his back. Besides its practical use, the gesture-language has much scientific interest from the perfect way in which it exposes the working of the human mind, expressing itself by a series of steps which are all intelligible. It will be particularly observed that it has a strict syntax; for instance, that the quality or adjective must always follow the subject or substantive it is applied to. Thus, "the white box" may be expressed by imitating the shape and opening of a box, and then touching a piece of linen or paper to show its colour; but if the signs be put in the contrary order, as in the English words, the native will be perplexed. It is worth while, in countries where gesture-language is regularly used, to note down the usual signs and their exact order.

In recording a vocabulary of a language not yet reduced to form in a grammar and dictionary, the traveller may seek for equivalents of the principal classes of words in his own grammar: verbs, substantives, adjectives, pronouns, prepositions, &c. But the structure of the language he is examining will probably differ from any he is familiar with, the words actually used not coming precisely into these classes. The best method is for the traveller to learn a simple sentence, such as, "the men are coming," and to ascertain what changes will convert them into "the men are going," "the women are coming." He thus arrives at the real elements of the language and the method of combining them. Having arrived at this point, he will be able to collect and classify current ideas, such as the following:—

Actions—as stand, walk, sleep, eat, strike, see, make, &c.

Natural Objects and Elements—as sun, moon, star, mountain, river, fire, water, &c.

Man and other Animals—as man, woman, boy, girl, deer, buck, doe, eagle, eagles, &c.

Parts of Body—as head, arm, leg, skin, bone, blood, &c.

Trees and Plants.

Numerals (noticing how far they extend, and whether referring to fingers).

Instruments and Appliances—as spear, bow, hatchet, needle, pot, boat, cord, house, roof, &c.

Arts and Pastimes—as picture, paint, carving, statue, song, dance, toy, game, riddle, &c.

Family Relationships (as defined by native custom).

Social and Legal Terms—as chief, freeman, slave, witness, punishment, fine, &c.

Religious Terms—as soul, spirit, dream, vision, sacrifice, penance, &c.

Moral Terms—as truth, falsehood, kindness, treachery, love, &c.

Abstract Terms, relating to time, space, colour, shape, power, cause, &c.

The interjections used in any language can be noted, whether they are organic expressions of emotion, like *oh! ugh! ur-r-r!* or sounds the nature of which is not so evident. Also imitative words which name animals from their cries, or express sounding objects or actions by their sounds, are common in all languages, and strike the stranger. Examples of such are *kah-kah* for a crow, *twonk* for a frog, *pututu* for a shell-trumpet, *huitschu* for to sneeze. When such imitative words are noticed passing into other meanings where the connection with sound is not obvious, they become interesting facts in the development of language; as, to take a familiar example from English, the imitative verb to *puff* becomes a term for light pastry and metaphorically blown-up praise.

It is only when the traveller has a long and close acquaintance with a tribe, that he is able to deal satisfactorily with the vocabulary and structure of their language. To be able to carry on a conversation in broken sentences is not enough, for an actual grammar and dictionary is required to enable philologists to make out the structure and affinities with other languages. It used to be customary to send out English lists of thirty or forty ordinary words to have equivalents put to them in native languages. As every detail of this kind is worth having, these lists cannot be said to be quite worthless, but they go hardly any way toward what is really wanted. They are liable to frequent mistakes, as when the barbarian, from whom the white man is trying to get the term "foot," answers with a word meaning "my leg," which is carefully taken down and printed. Such poor vocabularies cannot even be relied on to show whether a language belongs to a particular family, for the very word which seems to prove this may be borrowed. Thus, in a Melanesian island, the word for five is *lima*, which is doubtless a regular Polynesian word, but it by no means proves that the language of the

island in question is a real Polynesian language like the Maori. The islanders have, in fact, adopted it from Polynesians with whom they have been in contact, as other Melanesians have adopted the numbers *six*, *seven* from the English missionaries. While it is best not to underrate the difficulty of collecting such information as to a little-known dialect as will be really of service to philology, it must be remembered that travellers still often have opportunities of preserving relics of languages, or at any rate special dialects, which are on the point of dying out unrecorded. Where no proper grammar and dictionary has been compiled, it is often possible to find some European or some native interpreter fairly conversant with the language, with whose aid a vocabulary may be written out and sentences analysed grammatically, which, when read over to intelligent natives and criticised by them, may be worked into good linguistic material. It is worth while to pay attention to native names of plants, minerals, &c., as well as of places and persons, for these are often terms carrying significant meaning. Thus *ipecacuanha* is stated by Martius to be *i-pe-caa-guéne*, which, in the Tupi language of Brazil, signifies "the little wayside plant which makes vomit."

Arts and Sciences.—The less civilised a nation is, the ruder are their tools and contrivances; but these are often worked with curious skill in getting excellent results with the roughest means. Stone implements have now been so supplanted by iron that they are not easily found in actual use. If a chance of seeing them occurs, as, for instance, among some Californian tribe, who still chip out arrow-heads of obsidian, it is well to get a lesson in the curious and difficult art of stone-implementation making. In general, tools and implements differing from those of the civilised world, even down to the pointed stick for root-digging and planting, are worth collecting, and to learn their use from a skilled hand often brings into view remarkable peculiarities. This is the case with many cudgel- or boomerang-like weapons thrown at game, slings or spear-throwers for hurling darts to greater distances than they can be sent by hand, blow-tubes for killing birds, and even the bow-and-arrow, which in northern Asia and America shows the ancient Scythian or Tartar form, having to be bent inside out to string it. Though fire is now practically made almost everywhere with flint and steel or lucifers, in some districts, as South Africa or Polynesia, people still know the primitive method of fire-making by rubbing or drilling a pointed stick into another piece of

wood. Europeans find difficulty in learning this old art, which requires some knack. As is well known to sportsmen, different districts have their special devices for netting, trapping and other ways of taking game and fish, some of which are well worth notice, such as spearing or shooting fish under water, artificial decoys, and the spring-traps set with bent boughs, which are supposed to have first suggested the idea of the bow. While the use of dogs in hunting is found in most parts of the world, there is the utmost variety of breeds and training. Agriculture in its lower stages is carried on by simple processes; but interesting questions arise as to the origin of its grain and fruits, and the alterations in them by transplanting into a new climate and by ages of cultivation. Thus in Chili there is found wild what botanists consider the original potato; but while maize was a staple of both Americas at the time of Columbus, its original form has no more been identified than that of wheat in the Old World. The cookery of all nations is in principle known to the civilised European; but there are special preparations to notice, such as bucaning or drying meat on a hurdle above a slow fire, broiling kibabs, or morsels of meat on the skewer in the East, &c. Many peoples have something peculiar in the way of beverages, such as the chewed Polynesian *kava*, or the South American *maté* sucked through a tube. Especially fermented liquors have great variety, such as the *kumiss* from mare's milk in Tartary, the *pombe* or millet-beer of Africa, and the *kvass* or rye-beer of Russia. The rudest pottery made by hand, not thrown on the wheel, is less and less often met with, but ornamentation traceable to its being moulded on baskets is to be seen; and calabashes, joints of bambu, and close-plaited baskets, are used for water-vessels, and even to boil in. Among the curious processes of metal-working contrasting with those of modern Europe, though often showing skill of their own, may be mentioned the simple African smelting-forge by which iron-ore is reduced with charcoal in a hole in the ground, the draught being supplied by a pair of skins for bellows. In the far East a kind of air-pump is used, of which the barrels are hollowed logs. The Chinese art of patching cast-iron with melted metal surprises a European, and the Hindu manufacture of native steel (*wootz*) is a remarkable process. No nation now exists absolutely in the Bronze Age, but this alloy still occupies something of its old place in Oriental industry. As an example of the methods still to be seen, may be mentioned the Burmese bell-

founding, which is done, not in a hollow mould of sand, but by what in Europe is called the *cire perdue* process, the model of the bell being made in bees-wax and imbedded in the sand-mould, the wax running out as the hot metal is poured in. The whole history of machinery is open to the traveller, who still meets with every stage of its development, from savagery upward. He sees, for instance, every tilling implement from the stake with fire-hardened point, and the hoe of crooked branch, up to the modern forms of plough. In like manner he can trace the line from the rudest stone-crushers or rubbers for grinding seed or grain up to the rotating hand-mills or querns still common in the East, and surviving even in Scotland. From time to time some special contrivance may be seen near its original home, as in South America the curious plaited tube for wringing out the juice from cassava, or the net hammock which still retains its native Haitian name *hamaca*. Architecture still preserves in different regions interesting early stages of development, from the rudest breakwinds, or the beehive huts of wattled boughs, up to houses of logs and hewn timber, structures of mud and adobes, and masonry of rough or hewn stone. Even the construction of the bough-hut or the log-house often has its peculiarities in the arrangements of posts and rafters. Among the modes of construction which interest the student of architectural history is building with rough unhewn stones. Many examples of "rude stone monuments" are to be seen on our own moors and hills. The most familiar kinds are *dolmens* (i.e. "table-stones") formed by upright stones bearing a cap-stone; they were burial-places, and analogous to the cists or chambers of rough slabs within burial-mounds. Less clearly explicable are the single standing-stones or *menhirs* (i.e. "long-stones"), and the circles of stones or *cromlechs*. Ancient and obscure in meaning as such monuments are in Europe, there are regions where their construction or use comes down to modern times, especially in India, where among certain tribes the deposit of ashes of the dead in dolmens, the erection of menhirs in memory of great men, and even sacrifice in stone circles, are well-known customs. The traveller may also sometimes have opportunities of observing the ancient architectural construction by fitting together many-sided stones into what are sometimes called Cyclopean walls, a kind of building which seems to have preceded the use of squared blocks, fastened together with clamps or with mortar. Vaulting or roofing by means of courses of stones projecting

inwards one course above the other (much as children build with their wooden bricks), so as to form what architects call a "false arch," is an ancient mode of construction found in various parts of the world where the "true arch" with its keystone has not superseded it. It often appears that rude nations have copied the more artistic buildings of higher neighbours, or inherited ancient architectural traditions. Thus traces of Indian architecture have found their way into the islands of the Eastern Archipelago, and hollow squares of mud-built houses round a courtyard in northern Africa have their plan from the Asiatic caravanserai. In boat-building some primitive forms, as the "dug-out," hollowed by the aid of fire from a tree-trunk, and the bark-canoe, are found in such distant regions that we cannot guess where they had their origin. When, however, it comes to the outrigger-canoe, this belongs to a district which, though very large, is still limited, so that we may at least guess whereabouts it first came into use, and it is important to note every island to which it has since travelled. So there is much in the peculiar build and rig of Malay prahus, Chinese junks, &c., which is worth noting as part of the history of ship-building. This may suffice to give a general idea of the kind of information as to local arts which it is worth while to collect, and to illustrate by drawings and photographs of objects too large to bring away.

Naturally, nations below the upper levels of culture have little or no science to teach us, but many of their ideas are interesting as marking stages in the history of the human mind. Thus, in the art of counting, which is one of the foundations of science, it is common to find the primitive method of counting by fingers and toes still in practical use, while in many languages the numeral words have evidently grown up out of such a state of things. Thus the word *lima*, lately mentioned, meant "hand," before it passed into a numeral for five. All devices for counting are worth notice, from the African little sticks for units and larger sticks for tens, up to the ball-frames with which the Chinese and Russian traders reckon so rapidly and correctly. It is a sign of lowness in a tribe not to use measures and weights, and where these appear in a rough way, it is interesting to discover whether vague lengths, such as finger, foot, pace, are used, or whether standard measures and weights have come in. If so, these should be estimated according to our standards with as much accuracy as possible, as it may thus become possible to

ascertain their history. In connection with this comes the question of money, as to whether commerce is still in the rudimentary stage of exchanging gifts, or has passed into regular barter, or risen to regular trade, with some sort of money to represent value, even if the circulating medium be only cowries, or bits of iron, or cakes of salt, all which are current money to this day in parts of Africa. Outside the present higher civilisation, more or less primitive ideas of astronomy and geography will be found to prevail. Among tribes like the American Indians the obvious view suggested by the senses still prevails, that the earth is a flat round disc (or sometimes square, with four quarters or winds) overarched by a solid dome or firmament, on which the sun and moon travel—in inland countries going in and out at holes or doors on the horizon, or, if the sea bounds the view, rising from and plunging into its waves at sunrise and sunset. These early notions are to us very instructive, as they enable us to realise the conceptions of the universe which have come down to us in the ancient books of the world, but which scientific education has uprooted from our own minds. With these cosmic ideas are found among the lowest races the two natural periods of time, namely, the lunar month and the solar year, determined by recurring winters, summers, or rainy seasons. Such tribes divide the day roughly by the sun's height in the sky, but among peoples civilised enough to have time-measures and the sun-dial, there is a tolerably accurate knowledge of the sun's place at the longest and shortest days, and, indeed, throughout the year. The astronomy of such countries as India has been of course described by professional astronomers; but among ruder nations there is still a great deal unrecorded—for instance, as to the constellations into which they map out the heavens. This likening stars and star-groups to animals and other objects is almost universal among mankind. Savages like the Australians still make fanciful stories about them, as that Castor and Pollux are two native hunters, who pursue the kangaroo (Capella) and kill him at the beginning of the hot season. Such stories enable us to understand the myths of the Classical Dictionary, while modern astronomers keep up the old constellations as a convenient mode of mapping out the sky. As to maps of the earth, even low tribes have some notion of their principle, and can roughly draw the chart of their own district, which they should be encouraged to do. Native knowledge of natural history differs from much of their rude science in its quality, often being of great positive

value. The savage or barbarian hunter knows the animals of his own region and their habits with remarkable accuracy, and inherited experience has taught him that certain plants have industrial and medicinal uses. Thus, in South America the Europeans learnt the use of India-rubber or caoutchouc, which the native tribes were accustomed to make into vessels and playing-balls, and of the Peruvian bark or cinchona, which was already given to patients in fever.

Here a few words may be said of magic, which, though so utterly futile in practice, is a sort of early and unsuccessful attempt at science. It is easy, on looking into the proceedings of the magician, to see that many of them are merely attempts to work by false analogy or deceptive association of ideas. The attempt to hurt or kill a person by cutting or piercing a rude picture or image representing him, which is met with in all the four quarters of the globe, is a perfect example of the way in which sorcerers mistake mere association of ideas for real cause and effect. Examined from this point of view, it will be found that a large proportion of the magic rites of the world will explain their own meaning. It is true that this is not the only principle at work in the magician's mind; for instance, he seems to reason in a loose way that any extraordinary thing will produce any extraordinary effect, so that the peculiar stones and bits of wood which we should call curiosities become to the African sorcerer powerful fetishes. It will often be noticed that arts belonging to the systematic magic of the civilised world, which has its source in Babylon and Egypt, have found their way into distant lands more readily indeed than useful knowledge, so that they may even be met with among barbaric tribes. Thus it has lately been pointed out that the system of lucky and unlucky days, which led the natives in Madagascar to kill many infants as of inauspicious birth, is adopted from Arabic magic, and it is to be expected that many other magical arts, if their formulas are accurately described, may in like manner be traced to their origin.

Society.—One of the most interesting features of savage and barbaric life is the existence of an unwritten code of moral conduct, by which families and tribes are practically held together. There may be no laws to punish crime, and the local religion may no more concern itself directly with men's behaviour to one another than it did in the South Sea Islands. But among the roughest people there is family affection,

and some degree of mutual help and trust, without which, indeed, it is obvious that society would break up, perhaps in general slaughter. Considering the importance of this primitive morality in the history of mankind, it is unfortunate that the attention of travellers has been so little drawn to it that our information is most meagre as to how far family affection among rude tribes may be taken to be instinctive, like that of the lower animals, or how far morality is produced by public opinion favouring such conduct as is for the public good, but blaming acts which do harm to the tribe. It is desirable to inquire what conduct is sanctioned by custom among any people, whether, for instance, infanticide is thought right or wrong, what freedom of behaviour is approved in youths and girls, and so on. For though breaches of custom may not be actually punishable, experience will soon convince any explorer among any rude tribe that custom acts in regulating their life even more strictly than among ourselves. The notion of even savages leading a free and unrestrained life is contradicted by those who know them best; in fact, they are bound in every act by ancestral custom. While each tribe thus has its moral standard of right and wrong, this differs much in different tribes, and one must become intimately acquainted with any people to ascertain what are really their ruling principles of life. Accounts have been often given of the natural virtue and happiness of rude tribes, as in the forests of Guyana or the hills of Bengal, where the simple native life is marked by truthfulness, honesty, cheerfulness and kindness, which contrast in a striking way with the habits of low-class Europeans. There are few phenomena in the world more instructive than morality thus existing in practical independence either of law or religion. It may still be possible to observe it for a few years before it is altered by contact with civilisation, which, whether it raises or lowers on the whole the native level, must supersede in great measure this simple family morality.

The unit of social life is the family, and the family is based on a marriage-law. Travellers who have not looked carefully into the social rules of tribes they were describing, or whose experience has been of tribes in a state of decay, have sometimes reported that marriage hardly existed. But this state of things is not confirmed as descriptive of any healthy human society, however rude; in fact the absence of definite marriage appears incompatible with the continued existence of a tribe. Therefore statements of this kind made by former visitors should be

carefully sifted, and marriage-laws in general deserve careful study. The explorer may hardly meet with marriage at so low a stage that the union can be described as little beyond annual pairing; but where divorce is almost unrestricted, as in some African tribes, there is more or less approach to this condition, which is possible, though unusual, under such laws as that of Islam. Polygamy, which exists over a large part of the globe, is a well understood system, but information is less complete as to the reasons which have here and there led to its opposite, polyandry, as among the Toda hill-tribes and the Nairs in South India. Among customs deserving inquiry are match-making festivals at spring-tide or harvest, when a great part of the year's marriages are arranged. This is not only often done among the lower races, but traces of it remain in Greece, where the dances at Megara on Easter Tuesday are renowned for wife-choosing, and in Brittany, where on Michaelmas Day the girls sit in a row decked in all their finery on the bridge of Penzé, near Morlaix. The custom of bride-capture, where the bridegroom and his friends make show of carrying off the bride by violence, is known in Europe as a relic of antiquity, as in ancient Rome, Wales within the last century or two, or Tyrol at the present day; but in more barbaric regions, as on the Malay peninsula or among the Kalmuks of North Asia, it may be often met with, practised as a ceremony, or even done in earnest. On the other hand, restrictions on marriage between kinsfolk or clansfolk are more prominent among the lower races than in the civilised world, but their motive is even now imperfectly understood. Partly these restrictions take the form we are accustomed to of prohibiting marriage between relatives more or less near in our sense, but among nations at a lower level they are apt to turn on what is called exogamy or "marrying-out." A tribe or people, for instance the Kamilaroi of Australia or the Iroquois of North America, is divided into hereditary clans, members of which may not marry in their own clan. In various parts of the world these clans are named from some animal, plant or other object, and anthropologists often call such names "totems," this word being taken from the native name among Algonquin tribes of North America. For an instance of the working of this custom among the Iroquois tribes, a Wolf was considered brother to a Wolf of any other tribe, and might not marry a Wolf girl, who was considered as his sister, but he might marry a Deer or a Heron. In contrast with such rules is the practice of endogamy or "marrying-in," as among

the Arab tribes who habitually marry cousins. But it will be found that the two rules often go together, as where a Hindu must practically marry within his own caste, but at the same time is prohibited from marrying in his own gotra or clan. Researches into totem-laws are apt to bring the traveller into contact with other relics of the ancient social institutions in which these laws are rooted, especially the practice of reckoning descent not on the father's side, as with us, but on the mother's side, after the manner of the Lycians, whose custom seemed extraordinary to the Greeks in the time of Herodotus, but may be still seen in existence among native tribes of America.

Another point on which travellers have great opportunity of seeing with their own eyes the working of primitive society, is the holding and inheritance of property, especially land. Notions derived from our modern law of landlord and tenant give place in the traveller's mind to older conceptions, among which individual property in land is hardly found. In rude society it is very generally the tribe which owns a district as common land, where all may hunt and pasture and cut fire-wood; while, when a family have built a hut, and tilled a patch of land round it, this is held in common by the family while they live there, but falls back into tribe-land if they cease to occupy it. This is further organised in what are now often called "village communities," which may be seen in operation in Russia and India, where the village fields are portioned out among the villagers. Those who have seen them can understand the many traces in England of the former prevalence of this system in "common fields," &c. There is the more practical interest in studying the working of this old-world system, from the light it throws on projects of communistic division of land, which in such villages may be studied, and its merits and defects balanced. On the one hand it assures a maintenance for all, while on the other it limits the population of a district, the more so from the obstinate resistance which the council of "old men" who manage a village always oppose to any improved method of tillage. Not less perfectly do the tenures existing in many countries show the various stages of landholding which arise out of military conquest. The absolute ownership of all the land by a barbaric chief or king, which may be seen in such a country as Dahome, whose subjects hold their lands on royal sufferance, is an extreme case. In the

East, feudal tenures of land granted for military service still have much the same results as in mediæval Europe.

At low levels of civilisation, the first dawning of criminal law may be seen in the rule of vengeance or retaliation. The person aggrieved or his kinsfolk, if he has been killed, are at once judges and executioners, and the vengeance they inflict stands in some reasonable relation to the offence committed. Not only is such vengeance the great means of keeping order among such rude tribes as the Australians; but even among half-civilised nations like Abyssinians and Afghans the primitive law may still be studied in force, carried out in strict legal order as a *lex talionis*, not degraded to mere illegal survival in outlying districts like the "vendetta" of modern Europe, carried on even now in spite of criminal jurisprudence which for ages has striven to transfer punishment from private hands to the state. Whether among savages, barbarians, or the lower civilised nations, the traveller will find everywhere matter of interesting observation in the law and its administration. The law may be still in the state of unwritten custom, and the senate or council of old men may be the judges, or the power at once of lawgiver and judge may have passed into the hands of the chief, who, as among the modern Kafirs, may make a handsome revenue by the cattle given him as fees by both sides, a fact interesting as illustrating the times when a European judge took gifts as a matter of course. Among the nations at higher levels of culture in the East, for instance, most of the stages may still be seen through which the administration of law, criminal and civil, was given over to a trained legal class. One important stage in history is marked by religion taking to itself legal control over the conduct of a nation. The working of this is seen among Oriental nations, whether Mohammedan, Brahman, or Buddhist, whose codes of law are of an ecclesiastical type and the lawyers theologians. There is much to be learnt from the manner in which such law is administered, and the devices are interesting by which codes framed under past conditions of society are practically accommodated to a new order of things, without professedly violating laws held to be sacred, and therefore unchangeable. Ordeals, which have now disappeared from legal procedure among European nations, are often to be met with elsewhere. Thus, in Arabia the ordeal by touching or licking hot iron is still known (the latter is an easy and harmless

trick, if the iron is quite white-hot). In Burma, outside the British possessions, the ancient trial of witches by "swimming" goes on. In many countries also, symbolic oaths invoking evils on the perjurer are to be met with, as when the Ostyaks in Siberia swear in court by laying their hand on a bear's head, meaning that a bear will kill them if they lie. It shows the carelessness with which Europeans are apt to regard the customs of other nations, that in English courts a Chinese is called upon to swear by breaking a saucer, under the entirely erroneous belief that this symbolic curse is a Chinese judicial oath.

The most undeveloped forms of government are only to be met with in a few outlying regions, as among some of the lower Esquimaux or Rocky Mountain tribes, where life goes on with hardly any rule beyond such control as the strong man may have over his own household. Much oftener travellers have opportunity of studying, in a more or less crude state, the types of government which prevail in higher culture. It is of especial interest to see men of the whole tribe gathered in assembly (the primitive *agora*) to decide some question of war or migration. Not less instructive are the proceedings of the council of old men (the primitive *senate*), who, among American tribes or the hill tribes of India, transact the business of the tribe; they are represented at a later social stage by the village-elders of the Hindus or the Russians. Among the problems which present themselves among nations below the civilised level is that of the working of the patriarchal system, still prevailing among such tribes as the Bedaween, while often the balance of power is seen adjusting itself between the patriarchal heads of families and the leaders who obtain authority by success in war. The struggle between the hereditary chief or king and the military despot, who not only usurps his place but seeks to establish hereditary monarchy in his own line, is one met with from low to high levels of national life. The traveller's attention may be called to the social forces which do their work independently of men in authority, and make society possible, even when there is little visible authority at all. The machinery of government described in books is often much less really powerful than public opinion, which controls men's conduct in ways which are so much less conspicuous that they have hardly yet been investigated with the care they deserve.

Religion and Mythology.—While great religions, like Mohammedanism and Buddhism, have been so carefully examined that European students

often know more about their sacred books than the believers themselves, yet the general investigation of the religions of the world is very imperfect, and every effort should be made to save the details from being lost as one tribe after another disappears, or passes into a new belief. Missionaries have done much in recording particulars of native religions, and some have had the skill to describe them scientifically; but the point of view of the missionary engaged in conversion to another faith is unfavourable for seeing the reasons of the beliefs and practices he is striving to upset. The object of the anthropologist is neither to attack nor defend the doctrines of the religion he is examining, but to trace their rational origin and development. It is not only among the rudest tribes that religious ideas which seem of a primitive order may be met with, but these hold their place also among the higher nations who profess a "book-religion." Thus the English or German peasant retains many ideas belonging to the ancestral religion of Thor and Woden, and the modern Burmese, though a Buddhist, carries on much of the old worship of the spirits of the house and the forest, which belongs to a far earlier religious stratum than Buddhism. It is in many districts possible for the traveller to obtain at first hand interesting information as to the philosophical ideas which underlie all religions. All over the world, people may be met with whose conception of soul or spirit is that belonging to primitive animism, namely, that the life or soul of men, beasts, or things resides in the phantoms of them seen in dreams and visions. Quite lately, a traveller in British Guyana had serious trouble with one of his Arawaks, who, having dreamt that another had spoken impudently to him, on waking up went quite naturally to his master to get the offender punished. So it is reported that our officials in Burma have considered themselves disrespectfully treated when the wife or servant of the person they have come to see has refused to wake him, the Englishman not understanding that these people hold early animistic ideas, believing the soul to be away from the sleeper's body in a dream, so that it might not find its way back if he were disturbed. As scientific ideas of the nature of life and dreams are rapidly destroying these primitive conceptions, it is desirable to collect all information about them for its important bearing on the history of philosophy and religion. The same may be said as to the ancient theory of diseases as caused by demons, and the expulsion and exorcism of them as a means of cure, which may still be studied everywhere outside the

scientific nations. Information as to religious rites is of course valuable, even when the foreign observer does not understand them, but if possible their exact meaning should be made out by some one acquainted with the language, otherwise acts may be confused which have really different senses, as where a morsel of food offered as a pious offering to an ancestral ghost may be taken for a sacrifice to appease an angry wood-demon. A people's idea as to the meaning of their own rites may often be very wrong, but it is always worth while to hear what they think of the purpose of their prayers, sacrifices, purifications, fasts, feasts, and other religious ordinances, which even among savage tribes have been long since stereotyped into traditional systems.

Mythology is intimately mixed up with religion, which not only ascribes the events of the world to the action of spirits, demons, or gods, but everywhere individualises many of these beings under personal names, and receives as sacred tradition wonder-tales about them. Thus, to understand the religion of some tribes, we have not only to consider the rude philosophy under which such objects as heaven and earth or sun and moon are regarded as personal beings, whose souls (so to speak) are the heaven-god and earth-god, the sun-god and moon-god; but we have to go on further and collect the religious myths which have grown on to these superhuman beings. The tales which such a people tell of their origin and past history may to some extent include traditions of real events, but mostly they consist of myths, which are also worth collecting, as they often on examination disclose their origin, or part of it. This is seen, for instance, in the South Sea Island tale of the god Maui, whose death, when he plunged into the body of his great ancestress the Night, is an obvious myth of the sunset. The best advice as to native mythology is to write down all promising native stories, leaving it to future examination to decide which are worth publishing. The native names of personages occurring in such stories should be inquired into, as they sometimes carry in themselves the explanation of the story itself, like the name of Great-Woman-Night in the Polynesian myth just referred to. Riddles are sometimes interesting, as being myths with an explanation attached, like the Greek riddle of the twelve black and twelve white horses that draw the chariot of the day. It is not too much to say that everything which a people thinks worth remembering as a popular tradition, and all the more if it is fixed in rhyme or verse, is worth notice, as likely to contain some-

R

thing of historical value. That it may not be historically true is beside the question, for the poetic fictions of a tribe often throw more light on their history than their recollections of petty chiefs who quarrelled fifty years ago. The myths may record some old custom or keep up some old word that has died out of ordinary talk, or the very fact of their containing a story known elsewhere in the world may give a clue to forgotten intercourse by which it was learnt.

Customs.—It remains to say a few words as to the multifarious customs which will come under the traveller's observation. It does not follow that because these may be mentioned or described in books they need not be further looked into. The fact is that accurate examination in such matters is so new, that something always remains to be made out, especially as the motives of so many customs are still obscure. The practice of artificially deforming the infant's skull into a desired shape, which is not quite forgotten even in Europe, may be noticed with respect to the question whether the form to which the child's head is bulged or flattened is the exaggeration of the natural form of an admired caste or race. If not, what can, for instance, have induced two British Columbian tribes, one to flatten their foreheads and the other to mould them up to a peak? In tattooing, an even more widespread practice, it is well to ascertain whether the pattern on the skin seems to have been originally tribe-marks or other signs or records, or whether the purpose is ornament. In South-east Asia the two motives are present at once, when a man has ornamental designs and magical charm-figures together on his body. With regard to ornaments and costumes, the keeping-up of ancient patterns for ceremonial purposes often affords curious historical hints. Thus in the Eastern Archipelago, the old-fashioned garments of bark-cloth are used in mourning by people who have long discarded them in ordinary wear, and another case is found among some natives of South India, whose women, though they no longer put on an apron of leaves as their real ordinary garment, wear it over a cotton skirt on festival-days. Among the amusements of a people, songs are often interesting musically, and it is well to take them down, not only for the tunes but also for the words, which sometimes throw light on old traditions and beliefs. Dancing varies from spontaneous expression of emotion to complex figures handed down by tradition and forming part of social and religious ceremony. The number of popular games in the world is smaller

than would be supposed. When really attractive, they may be adopted from one people to another till they make their way round the world. Any special variety, as of ball or draughts, should therefore be noticed, as it may furnish evidence of intercourse by which it may have come from some distant nation.

Though the subjects of anthropological interest are not even fully enumerated in the present chapter, some idea may have been given of the field of observation still open to travellers, not only in remote countries, but even in Europe. In taking notes, the explorer may be recommended not to be afraid of tedious minuteness, whereas the lively superficiality of popular books of travel makes them almost worthless for anthropology.*

* More extended accounts of the departments of the Science of Man here noticed, and a list of works useful to advanced students, will be found in Tylor's 'Anthropology: an Introduction to the Study of Man and Civilization' (Macmillan and Co., 1881). [Editors.]

VI.

PHOTOGRAPHY.

*By W. F. DONKIN, M.A., F.C.S., A.C., Lecturer in Chemistry
at St. George's Hospital.*

THE traveller who wishes to take photographs of the scenery he may pass through has first to decide on the size of plate he intends to employ, for on this will depend the size and weight of all the necessary apparatus. The smallest size that is worth taking is that known as "quarter-plate," measuring $3\frac{1}{2} \times 4\frac{1}{2}$ inches; the largest size which admits of the apparatus being conveniently carried by one man is $7\frac{1}{2} \times 5$ inches. In countries where, as in India, porterage is cheap and easily obtained, larger sizes may be adopted, such as $8\frac{1}{2} \times 6\frac{1}{2}$, or "whole-plate;" but for general utility and convenience $7\frac{1}{2} \times 5$ is recommended. Intermediate sizes are 5×4 , and $6\frac{1}{2} \times 4\frac{1}{2}$, or "half-plate." The quarter-plate and 5×4 are known in the trade as "pocket" apparatus; but the pictures obtained by them are trivial in appearance unless subsequently enlarged. In the following remarks it will be assumed that $7\frac{1}{2} \times 5$ is the size adopted.

The weight of the entire apparatus necessary for taking twelve pictures, namely, camera, slides, 12 glass plates, lenses, leather case, and tripod stand, will be from 20 to 25 lbs. The weight of glass plates $7\frac{1}{2} \times 5$ inches averages 3 lbs. per dozen, and as the traveller should take with him from half a gross upwards, it is evident that the chief weight of the necessary photographic impedimenta is solid glass. The following list comprises all the apparatus necessary for taking photographs on dry plates.

1. *A camera.* This should be of the bellows-bodied form, of best mahogany, and brass-bound. It should have a movable front, capable of shifting both vertically and horizontally; and a double swing back; that is to say, the frame carrying the focussing glass and sensitive plates must be capable of turning on both a horizontal and vertical axis through several degrees in each direction away from the normal. There are now many good camera-makers in London; among the best may be named Mr. Meagher, of 21, Southampton Row, and Mr. Hare, of 26, Calthorpe Street, Gray's Inn Road.

2. *Slides for holding the sensitive plates.* These are frames which slide into the back of the camera in place of the focussing glass, which is removed. They each hold two sensitive plates, back to back, with an opaque partition between them, so that a dozen plates will require six slides or "double backs." Another system consists of a changing-box and single slide; but it is not recommended, being of delicate construction and liable to get out of order.

3. *A focussing cloth.* This is used for keeping out the light while focussing, being thrown over the camera and the head of the operator. It is generally made of black velvet, but waterproof sheeting is much better. It should have rings sewn on to one edge, or some arrangement by which it may be attached to the camera so as not to be blown away.

4. *Camera-stand.* There are many varieties of tripod stands, with legs either folding or sliding into a small compass. For mountainous country it is of great advantage to have a stand with sliding legs, as they can be readily altered in length so as to stand firmly on slopes or rocky ground. Kennett's is a good form of sliding stand, and is made in two or three different sizes. The smallest size, weighing about 3 lbs., and measuring 33 in. long when closed, and standing about 4 ft. 6 in. high, is steady enough to support a $7\frac{1}{2} \times 5$ camera without perceptible vibration in a moderate wind. Mawdsley's is another very good pattern.

5. *A small pocket level,* for levelling the camera on the tripod.

6. *Lenses.* There are two essentially different forms of lens in use for outdoor photography; the single meniscus lens, and the doublet. The former is the oldest, and for landscape work is by far the best lens that can be used. It has two slight disadvantages, however, namely, that it must be used with a rather small diaphragm, and that it very slightly distorts straight marginal lines, so that it is not so good for purely architectural work as the doublet lens, which works with a larger aperture and gives perfectly straight lines. The doublet consists of two exactly similar meniscus lenses, with their convex surfaces outwards. It is made in two forms, one with a large aperture and suitable for groups, portraits, and instantaneous pictures; the other with a small aperture and very small lenses. Of the former kind, Dallmeyer's "rapid rectilinear" lens is the best that can be chosen, while Ross makes a series of the latter kind under the name of "portable symmetrical," varying

from 3 in. to 15 in. focus. They are very small and light, and all screw into the same flange. The traveller will find it advisable to have not less than three lenses of different kinds and of different focal length. Assuming the $7\frac{1}{2} \times 5$ size of plate to be selected, the following lenses are recommended:—

a. Ross's portable symmetrical, 5 in. focus. (This embraces an angle of about 55° on the long diameter of the plate, and is useful for confined situations and interiors, but should seldom be used for an open landscape.) b. Dallmeyer's single meniscus lens, 7 in. focus. (This includes an angle of about 45° on the $7\frac{1}{2}$ in. plate, and will be found the most universally useful lens for ordinary landscapes, giving a brilliant image with great depth of focus.) c. Dallmeyer's rapid rectilinear, 11 in. focus, including about 37° . (For portraits, groups, distant views, or instantaneous pictures.)* It may be noted that any doublet lens may be converted into a single meniscus lens of about double the focal length by simply removing the front lens of the combination. Considerable economy may be effected by purchasing lenses secondhand from respectable dealers, such as Messrs. Watson and Son, 313, High Holborn; Mr. Morley, 70, Upper Street, Islington, or Messrs. Hunter and Sands, of 20, Cranbourne Street, all of whom can be recommended with confidence.

7. *Sensitive plates.* The wet collodion process, as applied to landscape photography, is now almost a thing of the past; and even in the studio it is rapidly giving way to the dry gelatine process, which for extreme sensitiveness has never been approached by any other process. Within the last few years this process has absorbed so much attention that the dry collodion process has been almost entirely abandoned. Gelatine plates are now made commercially by a large number of firms and of great excellence; they keep indefinitely before exposure, and for a long time afterwards and before development, and under some circumstances (as for instantaneous pictures, portraits and dimly lighted interiors) will give results which could hardly be obtained at all on collodion. Gelatine plates are made of various degrees of sensitiveness; the slowest plates are best for ordinary landscape work. They are generally supplied in

* If only landscape work is to be done, the first-named lens may be omitted, and if there is a choice between the other two, No. 3 should be selected, being of longer focus.

parcels of a dozen each, packed face to face with strips of folded paper between opposite edges. The card boxes in which they are usually packed are an insufficient protection against injury and damp. In all cases it is advisable, and for sea voyages and damp climates essential, to have each package of a dozen plates soldered down in a tin case, and afterwards packed in a light wooden box with tow or cotton wool, and the box screwed (not nailed) down. In packing them up again after exposure or after development, a good plan (due to Captain Abney) is to provide oneself with a number of cardboard frames exactly the size of the plates, made of strips of card about $\frac{1}{4}$ in. wide, one of which is inserted between every two face to face. The packages thus made up should be soldered down again and treated with at least as much care as the original plates.

8. *A lantern.* All manipulations of the plates until after development have to be done in a very dim red light, and this involves the use of a lantern. There are many forms of portable folding lantern now sold for the purpose; in choosing one the points to note are, that no white light should escape anywhere, and it should be large, so as to keep cool. A good form, folding like a Chinese lantern, is obtainable from Werge, 11, Berners Street. It is obvious that the transference and development of the plates must be done either at night or in a room from which daylight can be completely excluded. It will be found convenient to take a supply of brown paper and large drawing-pins, by means of which, with the help of a shawl or rug, almost any window can be completely blocked. When camping out, the development can of course only be done at night.

9. *Apparatus and chemicals for development.* The development of the plates after exposure in the camera requires practice and experience in order to secure the best results. Instructions for development are sent out with all commercial plates, but many failures would certainly result from attempting to work by these without some preliminary practice at home. It is not of course necessary to develop the plates *en route*, as they will keep after exposure for several months at least, and may be brought home for development; but for many reasons it is far more satisfactory to develop them while travelling. The following list comprises all that is absolutely required for developing 8 or 10 dozen gelatine or collodion plates:—Three papier-maché dishes, two 3-ounce glass measures, three 6-ounce bottles, containing strong solutions of pyrogallic acid,

potassium bromide, and ammonia respectively, 1 lb. hyposulphite of soda, and $\frac{1}{2}$ lb. alum, both in crystals, 4 or 5 feet of indiarubber tubing and a spring clip, to make a syphon for a water-supply from a jug or can, a basin or tub to serve as a sink, a folding rack for draining the plates.

The traveller is strongly recommended to study before starting some standard work on photography, such as that by Captain Abney,* and to practise the exposure and development of the plates he intends to use. He will save much time and trouble if he can do this under the supervision of some experienced photographer, for it must be clearly understood that without this preliminary practice nothing but failure and disappointment can ensue.

The aim of the traveller-photographer should be the production of good *negatives*. It often requires years of study on the part of professional operators (with advantages impossible to the traveller) before thoroughly good negatives are habitually produced; and it must not be supposed that a person taking up photography for the first time, in a few hurried moments before departure on a journey, will attain other than very unsatisfactory results.

The operations necessary for taking a picture are briefly as follows:— Having selected the position from which the view is to be taken (for valuable hints as to the *artistic* production of pictures see Robinson's 'Pictorial Effect in Photography'), the tripod stand is first set up, and the head approximately levelled by means of the pocket level, altering the position or length of the legs as may be necessary. The camera is next screwed on to the stand, and the lens selected which on trial is found to include the required amount of subject. For groups or portraits a long focus lens with wide aperture, such as Dallmeyer's "Rapid rectilinear," 11 in. focus, should be used. The next operation is to focus the picture accurately on the ground-glass screen of the camera. The focussing-cloth is thrown over the head and the camera, so as to exclude the light as much as possible, and while looking at the inverted image on the ground glass the milled head of the rack adjustment is turned till the image appears as sharp as possible. The camera is now turned about on its vertical axis till it exactly includes

* 'Instruction in Photography,' by W. de W. Abney, R.E., F.R.S (Piper and Carter). To be obtained from all photographic dealers. See also a most useful little pamphlet, 'The A B C of Modern Photography' (same publishers).

the view intended to be taken, and the screw is tightened. It may be necessary to raise or lower the front of the camera carrying the lens in order to include objects at a high or low elevation; if the vertical range of this sliding front is insufficient, the camera must be tilted; but if this is done, care must be taken to set the focussing-screen vertical again by means of the swing back, and to re-adjust the focus. The full aperture of the lens should always be used for focussing, and if the image is not sharp all over the plate it will be necessary to insert a diaphragm in the lens, using the largest that will effect the required object. Having then put the cap on the lens, the hinged frame carrying the focussing-glass is turned over, and one of the slides carrying the sensitive plates is inserted in its place. The slides should be exposed as little as possible to the light, especially avoiding direct sunlight; however carefully constructed it is difficult to make them absolutely light-tight. The shutter of the slide is then withdrawn, and the exposure made by removing the cap from the lens for the required time. The time of exposure must be estimated according to circumstances, and it requires considerable experience to judge of it accurately. A record should be kept in a notebook of every plate exposed, giving the number, date, time, exposure, subject, &c. If the plates cannot be developed the same evening, and the slides are wanted for fresh plates, they must be packed up again, and should be numbered. This is best done by marking the number on the back with a bit of dry soap. The image on the plate after exposure is latent and invisible, and has to be developed. This is effected by pouring on the plate, laid in one of the flat dishes, a dilute solution containing pyrogallic acid, ammonia, and potassium bromide. The excellence of the result largely depends on the due proportion between these constituents, and here more experience is perhaps necessary than in any other part of the process. The image having been fully developed, the plate is well washed, and then immersed in a solution of alum, which hardens the film. After another thorough washing it is "fixed" by immersion in a solution of sodium hyposulphite, which dissolves out the unchanged bromide of silver, and being once more well washed it is finished and must be set up in the rack to dry spontaneously. On no account must heat be applied, not even the warmth of sunlight, or the film will melt. When dry it must be varnished to protect the film. The printing operations are best deferred till the return home, as they would involve the

carriage of a large amount of extra apparatus. It is generally best to get the printing done by a professional printer; but if the traveller prefers to print from his own negatives he will find full instructions in 'The Art and Practice of Silver Printing,' by Robinson and Captain Abney.

As regards the expense of a photographic outfit, such as that described above, the following may be taken as average prices for the largest size recommended, namely, for plates $7\frac{1}{2} \times 5$ inches:—

Camera, 4 to 5 guineas.

Double slides, about 1 guinea each.

Lenses, as described above, No. 1, 3*l.* 10*s.*, No. 2, 3*l.* 15*s.*, No. 3, 7*l.* These may generally be obtained secondhand, in good condition, at a reduction of 25 or 30 per cent. on these prices.

[The above may be arranged to pack into a solid leather case, conveniently in the form of a knapsack, measuring about 16 in. wide, 12 in. high, and 5 in. deep. This can easily be carried on the back of one man, and is of a more convenient shape than the cases generally sold for the purpose.]

Tripod stand, 25*s.*

Lantern, 10*s.*

Gelatine plates, about 7*s.* per dozen.

Apparatus and chemicals for development, about 15*s.*

Total, exclusive of the plates, about 25*l.*

The plates and other apparatus, with the exception of the knapsack and its contents, and the tripod stand, are best packed for travelling in a strong basket, which is much better than a box, being more elastic and lighter. It will weigh, when packed with the apparatus and a gross of $7\frac{1}{2} \times 5$ plates, about 60 lbs. Quite recently, transparent sheets of gelatine have been successfully employed by Prof. Stebbing, of Paris, and by Pumphrey, of Birmingham, as a support for the sensitive film, in place of glass. The advantages of this to the traveller are obvious; as yet, however, the films have not had any extended trial. Stebbing's films are to be obtained from Messrs. Horne and Thornthwaite, 416, Strand; and Pumphrey's from Werge, 11, Berners Street, who supplies also a new form of camera adapted for their use.

VII.

MEDICAL HINTS FOR TRAVELLERS.

By G. E. DOBSON, M.A., M.B., Surgeon-Major, Army Medical Department.

I. PERSONAL CARE OF HEALTH.

Prevention is better than cure is an old saying well worthy of the traveller's special attention, for, whether he travel for pleasure, profit, or discovery, a halt must be made when the state of his health demands rest. The very important question, therefore, arises—how may health be generally maintained while on the move?

To this we reply—by strict attention to the following rules, which may be regarded as axioms :—

The surface of the body should be maintained as far as possible at an equable temperature always.

With this view flannel, as the most effective non-conducting and absorbent material, should be worn next the skin by day and by night. In very warm climates shirts made of a mixture of silk and wool may be preferred; they are very light yet absorbent. Again, as a protection against cold, two or more shirts of fine wool should always be preferred to a single thick one, a stratum of warm air being retained between the outer and inner shirts, and liability to chill so minimised; moreover, it answers better for travellers to take thin flannel shirts in considerable numbers rather than an assortment of various thicknesses, on account of the facility which such an outfit gives for suiting the clothing to various temperatures. One of the shirts only need have sleeves. When exposed to cold and piercing winds, lined and perforated chamois-leather under-vests are also exceedingly efficacious; they are very light and occupy little space; and a long woollen comforter should not be forgotten. In warm climates a short shirt of very fine flannel, or of flannel and silk without sleeves, fitting very loosely round the neck, and reaching only as far as the hips, may be worn under a thin linen or calico shirt, while the abdomen is supported and protected by a long wide silk scarf wound

two or three times round the body. In tropical countries, where the night temperature differs little from that of day, if a fine flannel undershirt be worn, the rest of the body and limbs may be clothed in any thin cotton or linen fabric. In certain parts of the tropics, however, where the level country is flanked by high mountain ranges, and very considerable lowering of temperature takes place at night (as in Jamaica, Ceylon, &c.), care must be taken either to wear woollen clothes at all times or to change to them before sunset. On the whole, the traveller will find a loose-fitting Norfolk jacket (buttoning up to the throat) and trousers of thin serge, worn over a short fine flannel shirt and thin loose calico drawers, very convenient.

The traveller's night clothes should consist of a long India flannel shirt, opening down the front, and fastening with linen buttons, or, preferably, by tapes, and a pair of long wide trousers of the same material, or of thin calico in very warm countries, capable of being drawn together round the waist by a running string.

All flannel garments should be of wool throughout, and made to fit *very loosely*, as the usage they are subjected to in hurried washing causes extensive shrinking even in the best material.

In tropical countries the head and spine should be effectively protected; the level rays of the sun at morn or eve are often more dangerous than the vertical.

The well-fitting ventilated pith-helmet, which forms such an effective guard against the mid-day sun, does not equally protect the sides of the head and the back of the neck from its horizontal rays at morn or eve; at such times, therefore, a light curtain of sufficient length should be attached to the rim of the helmet. This curtain at other times can be folded up and fastened round the helmet. If the head and spine be well protected, (the latter may be guarded by a double fold of flannel about three inches wide sewn on the back of the shirt from the neck-band to the loins), and spirituous liquors be avoided or taken with great moderation, the traveller or sportsman in the tropics need not fear exposure even to the mid-day sun. The writer, wearing a pith helmet, a flannel shirt and belt, and linen trousers, has for weeks successively, from sunrise to noon, traversed on foot, without the slightest injury to health, miles of tropical districts, when engaged in collecting zoological specimens. It may be

added, however, that the ordinary traveller will do well in availing himself of the protection afforded by a light white-covered umbrella. A folding Panama straw hat may be used with advantage in sub-tropical climates.

Avoid sleeping in a draught, and sitting in damp clothes.

Sleeping opposite open ports or under a wind-sail should be guarded against, and the traveller in the tropics cannot be too careful in avoiding chills on arrival of the ship in port, especially in places where the warm sea breeze is replaced by a cold land wind at night. In such localities there is great temptation to come up half-dressed from the stifling saloon and enjoy this cool breeze, which usually springs up about 9 P.M.; free perspiration is quickly checked, and, if this be continued, as may often happen, through remaining too long on deck, a serious chill may result, followed perhaps by fever, dysentery, rheumatism, pleurisy, or some such dangerous malady. As a rule, sleeping on deck cannot be recommended, but, if unavoidable, the whole body should be well covered up.

Sitting in damp clothes should be most carefully avoided as a most efficient cause of chill. Too much care cannot be taken, on completion of a journey, either on foot or horseback, to change the underclothing at least, and the body should be thoroughly rubbed with a rough towel; and, if from any cause a change be impracticable, the underclothing may be dried at a fire while the traveller is performing his ablutions, any garment being meanwhile thrown over the shoulders to prevent chill.

In the tropics, or in malarious regions, always sleep under mosquito curtains.

The advantages to be derived from strictly attending to this rule cannot be exaggerated. Besides acting as a protection from noxious insects, curtains are a real safeguard against malaria, and minimise the danger of exposing the naked body during sleep. They may be made very portable as follows:—A piece of fine but strong mosquito net, with rather wide meshes, about seven yards long by four wide, should have its extremities carefully united so as to form a wide cylinder. One end of this should be bound with calico and furnished with a long running string; the other should be gathered up and confined by a tightly strained copper wire fastened in a groove let into the outer margin of a circular piece of flat deal board about one foot in diameter; to the centre of this board the

end of a coil of strong cord is fixed. Such curtains can be instantly fixed in position wherever the bed or hammock may be stretched. The long cord may be thrown over the cross-tie of a rafter of a hut, over a branch of a tree, or be hitched to the pole of a tent, carrying with it to any desired height the circular piece of board supporting the curtains, which may then be spread over the bed and secured round it beneath with the running string. Enclosed within such a fence the traveller may sleep undisturbed by noxious insects, uninfected by malarious poisons.

In the tropics, especially in regions known to be malarious, never venture out of doors till the sun has risen ; early rising is fatal in malarious localities.

The truth of this aphorism, strange though it may appear, is fully recognised by old settlers on the malarious West Coast of Africa, and the rationale of it is not difficult to seek. Just before sunrise the ground has lost by radiation the greatest amount of the heat absorbed during the previous day, and the damp unwholesome vapours settle down in greatest density over low-lying places, (as may be seen by anyone looking down on plains from a height just before sunrise), till subsequently dissipated by the heat of the rising sun. The three or four hours before sunrise, then, are especially dangerous, and the more so as each hour is nearer sunrise. Other reasons also should detain the wearied traveller indoors at this time, for it is then, when the tropical temperature has reached its minimum, that sleep is possible, and most refreshing.

Prolonged immersion of the body in cold water, when bathing, should be avoided in all climates.

Much misapprehension on the subject of cold bathing, which is often carried to excess, exists in this country. In the tropics regular bathing is absolutely necessary for cleanliness and comfort, but certain rules should be strictly adhered to:—(1) Avoid very cold bathing. The well water of tropical countries is often many degrees colder than the surrounding air, and prolonged immersion in it leads to congestions of the internal organs. If cold water be used it should be quickly poured over the body, which should be rapidly and thoroughly dried by strong friction with rough towels. In the case of those who have suffered from congestions of internal organs, the results of fevers or dysenteries, warm bathing is alone safe. (2) Bathing should take place only when the process of

digestion is completed, as in the morning on rising from bed, and should never be indulged in immediately after meals. After exercise, when the surface is warm and perspiring freely, a bath rapidly taken and followed by friction with rough towels is refreshing and beneficial; not so, however, when the body has cooled down. (3) After bathing or wading in the waters of tropical countries the skin should be thoroughly dried, care being especially taken to remove all moisture from depressions where it may escape the action of the towel, otherwise an opportunity for lodgment is afforded to the numerous vegetable and animal parasites which infest such waters. (See below, p. 272.)

Excess, whether in eating or in drinking, should be carefully avoided, and the quality of the meat and water particularly inquired into, especially in the tropics.

In the tropics, except when undergoing much physical exertion, meat as an article of diet should be used with moderation, and never oftener than twice in the twenty-four hours. Especially should the too common practice of heavy luncheons be discouraged, and the organs of digestion have complete rest during the greater part of the day-time. Highly-spiced foods, such as pepper-pot and curries, provoke indigestion and liver complaints; curries are used by the natives of India as digestive adjuncts only to their bulky rice diet.

While temperance in the use of spirituous liquors is earnestly recommended, it must, however, be allowed that there are occasions when the use of alcohol is imperative. It may be laid down as a general rule that for persons of sound constitution, in temperate climates, intoxicating liquors of all kinds should be regarded merely as luxuries, the use of which rarely benefits and often proves most injurious, and there is scarcely any condition in which hot coffee or tea (when procurable) or a tea-spoonful of Liebig's extract of meat dissolved in warm water, or of the various preparations of cocoa or chocolate and milk, may not be substituted with advantage by the wearied or benumbed traveller. In tropical regions, however, the depressing effects of the climate, except on robust constitutions, often show themselves in a general feeling of lassitude, attended with a feeble intermitting pulse and a sense of sinking in the region of the heart. When such feelings are really experienced, as they often are after prolonged physical exertion, the use of pure spirit

(whisky or brandy) in small quantity, copiously diluted, acts like a charm, and may be regarded as a true medicine, to be employed, however, with great caution. The writer, himself practically a teetotaller at home, has experienced abroad the benefit of the use of alcohol in moderation, when travelling and collecting in tropical parts of the three great continents; and in his own opinion, no less than in that of many others who have also undergone much physical exertion in India and in tropical Africa without damage to their constitutions, continued labour, such as that of the sportsman and traveller, cannot be safely maintained for any length of time unassisted by the occasional and judicious use of alcohol. It must, however, be clearly understood that the habitual use of alcohol is in no respect recommended, for, to be effective, it should be considered as a medicine, to be employed only when absolutely necessary.

With the single exception of the best brands of champagne, the writer is unable to recommend, beside pure whisky and brandy, any other form of alcoholic beverage for use in the tropics. Beer and porter, especially the stronger kinds, provoke liver derangements, and claret of good quality can rarely be obtained by the traveller.

Fresh meat and all kinds of vegetables, in the tropics, should be thoroughly cooked, and the drinking water filtered and boiled. If this be neglected they may be vehicles for introducing various internal parasites, such as tape-worms, round-worms, flukes, &c., and other more formidable diseases, as cholera and dysentery, have been often traced to an impure water supply. Pocket filters are now made very portable and effective, and should form part of the kit of every traveller. If unfiltered water be used, it should be boiled, or alum (six grains per gallon) be added, and after agitation allowed to settle, the clear fluid being subsequently drawn off above; or it may be made into tea, in which form it is quite innocuous and a refreshing beverage. In the tropics, where the skin acts so freely, a comparatively large supply of drinking water is necessary, especially after continued muscular exertion, and, so long as it is pure, may be drunk freely in moderation.

It should be distinctly understood, however, that the practice of freely yielding to the sensations of thirst, which at first so sorely trouble the traveller on foot in warm climates, is to be especially deprecated, as the more liquid consumed the more is required, leading to excessive perspiration, which not only saturates the clothing and predisposes to chill, but

also seriously weakens the muscular power, and probably increases the liability to sunstroke. The writer, when undergoing severe bodily exercise while collecting natural history specimens for hours together under a tropical sun, has found a small pocket-flask of cold tea (without milk or sugar) supply all the liquid nourishment required, thirst being subsequently freely satisfied on returning to camp by draughts of cold boiled water (*not iced*). If the craving for fluid, which comes on so soon after setting out on a journey on foot, be steadfastly resisted, it is surprising how little will be found sufficient. At other times, however, when at rest, occasional large draughts of pure water are beneficial, reducing the high specific gravity of the urine and its consequent irritating qualities, resulting from the excessive action of the skin, and mechanically lessening the general tendency (in tropical climates) to constipation.

To sum up, when travelling in places notoriously malarious the use of quinine in small doses, two grains three or four times in the twenty-four hours, or five grains twice daily, two or three times a week, with nourishing food and alcohol in moderation, sleeping under mosquito curtains, and not venturing out of doors until the sun has risen may be mentioned as the most effective prophylactic measures against fever.

2. RECOGNITION AND TREATMENT OF DISEASE.

A. MEDICAL DISEASES.

Sea-sickness.

From the British Isles the way to other countries necessarily leads over the sea, and, at the outset of his journey, the traveller is exposed to the inconvenience, sometimes very serious, of sea-sickness. To avoid this all excesses in eating or drinking should be abstained from immediately before embarking, and the following should be taken on the night previous:—Calomel, James's powder, of each four grains, extract of hyoscyamus ten grains; rub up together and take at bedtime; this should be followed by a strong Seidlitz powder next morning. Having eaten with moderation, the traveller, immediately the ship is under way, should get comfortably into his berth, and having well covered himself with rugs and, if possible, had a hot water jar placed at his feet, ought to adopt the horizontal position and compose himself to sleep. In this way, except in persons especially prone to suffer, sea-sickness may be avoided. If, how-

ever, sickness supervenes, one of Rigollot's mustard leaves moistened with water may be applied and kept tightly pressed for about ten minutes over the stomach, and a teaspoonful of the following should be taken every half hour:—Dilute hydrocyanic acid, thirty-two drops; bicarbonate of potash, one drachm; water, two ounces. Small pieces of ice allowed to dissolve slowly in the mouth also relieve sickness, and, if this be so severe as to seriously affect rest, sleep may be generally induced by a draught of thirty grains of chloral to two ounces water. Hutchison's treatment, (said never to fail), consists in the administration of a teaspoonful of the following mixture every ten minutes:—Bromide of sodium ten grains, powdered ipecacuanha one-tenth of a grain, in half-a-tumblerful of water; five or six doses often suffice. Pressure, (by means of a pad and broad bandage), over the stomach and abdomen is strongly recommended.

Colds in the Head, Coughs, Pleurisy, Pneumonia, Rheumatism.

Colds in the head are common on board ship, and generally result from exposure to sudden changes of temperature, as when passing from the warm and badly ventilated cabin to the deck. If neglected, the inflammation often spreads from the nose to the windpipe and thence to the lungs. In the first stage the disease may frequently be cut short by using the following powder as snuff:—Hydrochlorate of morphia, two grains, powdered gum acacia and white bismuth, of each two drachms; mix thoroughly and keep in a wide-mouthed bottle. This powder should be well applied to the interior of the nostrils frequently. In the second stage, mustard leaves should be applied over the windpipe and retained in position about ten minutes, to be followed by a warm poultice, and, at bedtime, five to ten grains of Dover's powder with or without five grains of quinine. In the third stage, attended with frothy sputa, hurried respiration, cough, and occasionally pain in the chest, with wheezing, the mustard and linseed should be applied to the chest, paregoric elixir (Tinct. camphoræ comp.) given in doses of from half a teaspoonful to one teaspoonful every third or fourth hour, and warm whiskey and water taken (if there be much difficulty in breathing) in doses of a wineglassful, to which five drops of spirits of turpentine have been added, every hour till relief is effected. Feverish colds in tropical countries may have a malarious basis and require quinine in large doses.

Pleurisy, essentially a disease of cold climates, is the result of a chill however caused. Symptoms:—Shiverings, pain in the side increased by a deep respiration, by coughing, and by pressure; skin hot and dry, pulse rapid. Treatment:—Confinement to bed, large and warm linseed poultices, spread on tow, to the affected side, preceded, if possible, by turpentine fomentations, and, every sixth hour, give the following:—Dover's powder, five grains, tartar emetic, one-fourth of a grain. If pain be very severe, half a dozen leeches may be applied. Diet:—Nourishing broths and cooling drinks.

Pneumonia, or acute inflammation of the substance of the lung, commences with general febrile disturbance, shiverings, sickness, cough, pain in the side, very rapid pulse, burning heat of skin, flushed face, thirst, and headache. Subsequently the sputa becomes very viscid, rusty, and streaked with blood, and the respiratory murmur is lost in the affected lung. Treatment:—As for pleurisy, but poultices should surround the chest: sal volatile, twenty drops in water every second hour or oftener; if pain and restlessness be present, tincture of opium, ten to fifteen drops every third hour; if the difficulty of breathing be intense, bleeding (eight to ten ounces) from the arm often alone gives relief. Diet:—Nourishing broths, and, if weakness set in, brandy beaten up with egg in small doses often repeated.

Rheumatism, generally the result of exposure to wet or cold. The acute, febrile form is ushered in with shiverings, followed by feverishness, pains in the limbs, especially in the joints, great thirst, rapid pulse, skin at first dry, then covered with clammy perspiration, having a characteristic sour, *butter-milk smell*. Treatment:—Calomel and James's powder, of each six grains, extract of hyoscyamus ten grains; rub up together: to be taken the first night, and to be followed next morning by a dose of the effervescent citro-tartrate of soda (No. 10), the body to be warmly covered in bed and the joints wrapped up in flannel. Then give a grain each of opium and ipecacuanha with eight grains of nitre every two hours until three doses are taken, and then one dose every tenth hour. If pain be severe, ten grains of Dover's powder may be given every night.

Constipation.

Is generally experienced on board ship, and requires no treatment unless it is not relieved naturally before three or four days. Saline

purgatives are, as a general rule, to be preferred to pills; and two teaspoonfuls of the effervescent citro-tartrate of soda may be taken in a tumblerful of water on rising in the morning. It is, however, sometimes a symptom of rupture (see p. 271); if so, carefully avoid purgatives.

Colic.

Severe griping or twisting pains in the abdomen, not increased by pressure. Give castor-oil, one to one and a half ounce, tincture of opium twenty drops, essence of peppermint ten drops, and apply hot turpentine fomentations.

Diarrhoea.

Resulting from errors in diet may be treated as above recommended for colic. If, however, it occur after a chill or in places where dysentery or cholera is known, a dose of thirty drops of chlorodyne may be substituted, to be followed at bedtime by five to ten grains of Dover's powder. Usually a change to a diet of well-boiled arrowroot and milk, with port wine or brandy, will suffice.

Dysentery, or Inflammation of the Lower Bowel.

Of all the diseases to which the traveller in tropical climates is exposed, this is, probably, most to be feared, although, happily, few yield more readily, if taken in time, to appropriate treatment. The most common causes are sudden and prolonged chills, and the evil effects of bad drinking-water and impure or improperly cooked food, the avoidance of which has been specially dwelt upon in the preceding pages.

The acute dysentery of tropical climates usually commences with simple diarrhoea, followed by shooting and irregular griping pains in the abdomen. This is succeeded by straining at stool and discharge of gelatinous mucus. As the disease advances the griping pains become much more distressing, the calls to stool more frequent, the discharges are tinged with blood and have the characteristic offensive smell, and there is pain on pressure over the abdomen. In this, the first stage of the disease, treatment is usually effective and should be immediately carried out as follows:—The patient should be confined to bed, turpentine fomentations applied to the abdomen, followed by a large linseed poultice; a mustard leaf placed over the stomach, and twenty drops of tincture of opium in half a wineglassful of water administered, to be followed in ten minutes

by a dose of twenty to thirty grains of ipecacuanha powder mixed in a small quantity of water. The patient should endeavour to avoid vomiting as long as possible, and with this view fluids should be abstained from. The dose of ipecacuanha may be repeated twice at intervals of six hours, and ten grains of Dover's powder given at bedtime. During the course of the disease, and for some time after the acute symptoms have been relieved, the food should consist, exclusively, of boiled milk, animal broth free from fat, and well boiled arrowroot.

Where the dysentery is complicated with malarial poisoning, quinine in fifteen to twenty grain doses is indicated in addition to the above treatment, but, in advanced cases, Dover's powder, (ten to fifteen grain doses), should be used instead of the ipecacuanha, and the patient's diet should consist of boiled milk absolutely, with brandy and port wine to support strength.

Diet is all-important in this formidable disease, and, therefore, the above directions should be carried out to the letter. *The smallest particle of solid food may set up irritation which may prove fatal*, especially in advanced cases. The constipation from which patients, nearly convalescent, who have been long restricted to milk diet, are liable to suffer, may be safely relieved by ounce doses of freshly-drawn castor oil.

Fevers (Malarious and Continued).

Malarious fevers are, of all diseases, probably the most likely to be contracted by the traveller in tropical regions. The *intermittent* and the more serious *remittent* forms are characterised by a cold, a hot, and a sweating stage, but, whereas in the former, the last stage is followed by a period of complete *intermission* of the disease, (during which the patient is restored apparently to health), in the latter a *remission* only of the symptoms takes place, the febrile condition being modified, not removed.

The premonitory symptoms of the approach of an ague fit are a general feeling of lassitude and malaise, of sinking at the pit of the stomach, and of cold down along the back; the face becomes pale, the features shrink, the teeth chatter, the lips and nails turn blue, and the patient complains of pains in the head, back, and loins. If now the bulb of a clinical thermometer be placed in the arm-pit or under the tongue, and retained there, closely appressed, from five to ten minutes, the index will be found, on carefully removing it, to point to some degree over 98°4' (the normal

temperature) notwithstanding the patient's sensations of intense chilliness. This, the only sure test, should always be employed when fever is suspected, and its indications should guide the administration of medicine.

The treatment of ordinary ague consists in the administration of fifteen to twenty grains of quinine about two hours before the expected attack. In bad forms, and in remittent, it is advisable not to wait for an intermission, but to give (except during the hot stage) the medicine in doses of fifteen grains at intervals of eight hours. Where there is great irritability of the stomach, the dose may be preceded by fifteen drops of tincture of opium, and cooling effervescing draughts may be given at intervals. In the worse forms the strength must be supported by nourishing broths, port wine and champagne, or by brandy in small but repeated doses largely diluted. If delirium supervene, ice or cold water to the head, and purgation with calomel (eight to ten grains), are indicated. During the attack the patient must be confined to bed.

Treatment by quinine sometimes, however, fails. When this occurs purgatives are indicated, and two of No. 11 pills should be given at bedtime, to be followed next morning by a draught of the effervescent citro-tartrate of soda (No. 10); the quinine may then be given at the proper time to anticipate the next attack. Emetics also are occasionally required to precede the quinine, especially when there is sickness of the stomach or the attack has come on after a meal; the following acts quickly: mustard flour, one tablespoonful; salt, one teaspoonful; warm water, half a pint; mix, and take all at once.

In the continued fevers, such as typhoid, typhus, scarlatina, small-pox, and measles, the same general rules are applicable to each, namely:—Absolute rest in bed, strict quarantine, thorough ventilation of the sick-room without draught, nourishing broths, cooling drinks, attentive nursing (*the patient should never be left alone*). Little medicine is needed, and should be given only under medical advice.

Liver Congestions and Abscess.

Although these are in most cases probably the results of malarial poisoning, a very large proportion must be put down to immoderate indulgence in highly spiced food and in alcohol. Simple congestion of the liver is characterised by a feeling of weight and fulness on the right side

of the stomach, and the enlarged organ in thin individuals may be felt projecting below the ribs; as the disease advances there is pain increased by pressure over the right side of the stomach, and sometimes felt in the shoulder, attended with difficulty in lying on the right side. If unrelieved, abscess may quickly follow in hot climates. Treatment:—Calomel and James's powder, of each six grains, extract of hyoscyamus ten grains; rub up together, and take at bedtime; in the morning a teaspoonful of effervescent citro-tartrate of soda in a tumblerful of water, and smaller quantities of the same at intervals, subsequently, to keep up the action of the bowels. If this fails to relieve, employ hot turpentine fomentations, and give twenty drops of wine of ipecacuanha in half a wineglassful of water every two or three hours. Rest and a restricted diet of vegetable food is also necessary.

If, in addition to intensification of all the above symptoms, we have superadded occasional or continued vomiting and night sweats, abscess may be reasonably suspected, requiring special medical treatment.

Night Blindness and Snow Blindness.

The first-named is the result of the combined effects of long-continued exposure to the intense glare of a tropical sun, with scurvy or weakness induced by bad food and overwork, &c.; the latter from over-excitation of the retina, caused by the glare from snow when travelling at a high elevation, or in the arctic regions. The treatment of both consists in resting the eyes, and in the use of antiscorbutic remedies, such as lime-juice, fresh meat and vegetables, and a change to better food.

Travellers in sandy regions or over snow-covered ground should wear spectacles, such as those figured below,* which should be fitted with smoked glasses; or, as a makeshift only, an ordinary pair may be rubbed over with any opaque substance, leaving a narrow horizontal slit of clear glass, in the Esquimaux fashion, as shown in the woodcut below. On

* From Messrs. Beck's Catalogue. For Arctic travellers and for those ascending high mountain ranges where the cold is intense, the metal framework of such spectacles renders them unwearable, and goggles with india-rubber or wooden rims, and fastened by an elastic band passing round the head, are recommended instead. Such goggles may be obtained at Messrs. Weiss's, Strand, or, by order, through any spectacle-maker.

snow, however, the perforated wire-gauze sides are essential parts of the protection from the refracted rays of the sun. Elastic may be substituted with advantage for metal attachments between the glasses as well as round the head.

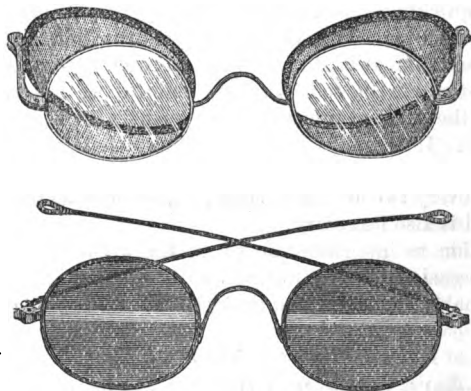

Ophthalmia, Iritis, &c.

Ophthalmia, or inflammation of the surface of the eye, is characterised by diffused redness of the eye, which is weak, intolerant of light, and watery; there is also a feeling as if sand had got under the eyelids, with pain in the head and slight fever, often the result of cold, but also sometimes contracted by contagion. *Treatment*: Administer a purgative, place a shade over the patient's eyes, and keep him in a darkened room. Bathe the eyes frequently with tepid water, and drop into them occasionally a lotion of one grain of sulphate of zinc to half a wineglassful of rain water. If the inflammation be severe, place a small blister on the side of the temple behind the eye, and keep it on for six hours; or apply one or two leeches in the same position. *Iritis*, inflammation of the iris or circular curtain surrounding the pupil, is distinguished from *ophthalmia* by the injected blood-vessels running in straight lines from the margin of the iris across the white portion, by the different colour of the iris of the affected eye, and by the greater pain in the eye-ball. *Treatment*: Give two grains of calomel with one grain of opium every fourth hour until

the gums become slightly tender, smear ointment of belladonna round about the eye, and apply leeches to the temples.

Piles or Hæmorrhoids.

Persons afflicted with this troublesome disease should not venture upon a journey likely to last for any considerable time, and should especially avoid warm climates, where it is likely to become much aggravated.

Piles are vascular dilatations of the mucous membrane of the bowel in the vicinity of the orifice. They may be external or internal; the latter are most troublesome, often causing pain and straining at stool, with discharge of blood, staining the fæces. When inflamed, fomentations or poultices should be applied, and calomel, half a capsule; opium, one pill; should be taken at night, to be followed next morning by a dose of castor-oil, or a draught of the citro-tartrate of soda (No. 10); the parts should, subsequently, be bathed with cold alum-water, and, if they protrude, should be returned with gentle pressure, having been previously oiled. Gall ointment is an excellent application for either external or internal piles, and the traveller (likely to suffer from them) should carry a sufficient quantity of the freshly prepared ointment, rubbed up with a few drops of glycerine, and put up in a well-closed tin.

The principal causes are congestions and other diseases of the liver, generally induced by over indulgence in highly-seasoned food and in drink. Sedentary pursuits, sitting long on soft cushions, and constipation, are common predisponents. Regular open-air exercise, regular living, and keeping the bowels open are the best preventives.

Prickly-heat and Ring-worm.

These very troublesome skin affections are well known in certain parts of the tropics. The former, the result of heat, may be relieved by sponging the part with vinegar and water, or dusting over with simple starch powder, (to each ounce of which fifteen grains of oxide of zinc may be added with much advantage), and wearing linen or light cotton clothes instead of flannel, which may be safely done where the temperature, though high, is equable; the latter is caused by a parasite introduced into the skin when bathing in waters infested by its spores; it is easily cured, if taken in time, by the application of tincture of iodine to the affected part.

Sleeplessness.

Excessive heat or cold, over-fatigue, the attacks of mosquitos and other insects, thirst and indigestion (generally caused by retiring to bed immediately after a heavy meal), and the use of strong tea or coffee at late hours, are the most common causes of this distressing condition, which, if unrelieved, by weakening the body, renders it liable to the inroads of malaria or other diseases. The traveller should therefore endeavour to procure an upper room (where there is better circulation of air), and, as already recommended, sleep under mosquito curtains, outside which a punkah (if possible) should be kept in action, and he should avoid the causes enumerated above. An india-rubber or tin hot-water bottle should be included in the kit of every traveller journeying in cold climates or in elevated regions, for of all causes of sleeplessness none is more potent than coldness of the feet.

Sunstroke.

Not limited to tropical climates; the result of continued exposure to the direct rays of the sun or to a superheated atmosphere, and should always be looked out for when the temperature exceeds 98° Fahr.; rare in insular climates, as in Jamaica, Ceylon, &c. When premonitory symptoms are present, such as unusual dryness and heat of the skin, giddiness, congestion of the eyes, and sickness of the stomach, an attack may be warded off by wrapping a well wetted cloth round the head and back of the neck, or, better, by the direct and continued application of cold water to these parts; if, on the other hand, as often happens, the patient falls down suddenly, he should be at once removed to the nearest shade, stripped, and douched plentifully with cold water over the head and chest. If complete sensibility be not restored by these means, a blister should be applied to the nape of the neck, and eight grains of calomel placed on the back of the tongue.

Tupe-worms and other Internal Parasites.

Unfiltered water, and imperfectly cooked food, animal or vegetable, are the sources whence intestinal parasites are introduced into the system. Others, occupying the connective tissue beneath the skin, as the guinea worm, are undoubtedly introduced most commonly by bathing or wading in the waters of tropical countries where they abound. Attention to the

quality of the food and drink, (as recommended above, p. 256), will, in ninety-nine cases out of a hundred, prevent the former, while the latter are avoided by washing with carbolic soap, carefully drying the surface of the skin afterwards, and rubbing carbolic oil into the most exposed parts. Effectual remedies for tape-worms are known in the countries most infected by them, amongst which kousso, given in doses of five drachms, is to be preferred. Assafœtida has been recommended as a specific for guinea worm, (ten to fifteen grains three times daily), but travellers affected with these parasites should at once obtain the best local medical advice.

B. SURGICAL DISEASES.

Bleeding or Hæmorrhage.

Venous blood is known by its dark appearance, *arterial* by its bright red colour and by spouting forth in jets; the latter is more dangerous and should be controlled at once. Bleeding may be stopped by direct pressure with a finger, or by superimposed pads, that over the bleeding point should be small and rolled very hard, the others larger by degrees and the outer fixed in position by a bandage. If from a small artery at the bottom of a wound, the spouting vessel should be seized with a fine pointed forceps and drawn sufficiently forward to admit of a strong thread being firmly tied round it. Bleeding from any of the chief arteries of the body or limbs, (the position of which may be traced by their pulsation), can be efficiently treated only by a surgeon; meanwhile continued pressure with the finger, kept up steadily for hours by men relieving one another from time to time, should be persevered in.

Blisters on the Feet.

Generally caused by an ill-fitting boot or sock; the greatest pains should therefore be taken before starting on a journey to obtain well-fitting boots, and those should be got into wear some time before departure; the sock, especially, should accurately fit the foot. If the blister be small it may be prevented from bursting by placing a piece of adhesive plaster (soap cerate), or even of gummed paper, such as a postage stamp, over the part so as to prevent friction; even if a small abrasion has formed this treatment will often permit of a journey on foot being continued. If

the blister be large, open it at its lower edge by pricking with a needle, preserve the skin over it, apply zinc ointment, and give rest till healed. Tender feet should be bathed frequently in strong hot salt-and-water to which a little alum has been added. To prevent blisters and chafes of the feet from hard boots, rub the latter internally with soft soap.

In selecting boots for a journey on foot the following points should be specially attended to. The boots should have: (1) broad and low heels, never exceeding one inch in height; (2) broad tread, 4 inches wide for an ordinary foot; (3) elevated toe-cap to make room for great toe.

Boils and Carbuncles.

A carbuncle is an exaggerated boil. Both commence as a small irritable elevation of the skin of a red colour; this may often be kept back by touching it occasionally with tincture of iodine or lunar caustic. If not so arrested apply poultices (of linseed-meal, or of boiled carrots, &c.), and, if the patient be debilitated, give quinine, two to five grains three times daily, with nourishing food and stimulants; if, on the contrary, he be plethoric, saline purgatives are indicated. If the carbuncle cause much tension with great pain a deep and wide X-cut with a very sharp knife will give relief at once. The cut surface should then be poulticed.

Bruises.

If slight, require little treatment, if severe, the injured part should be fomented continually with flannels wrung out of boiling water; two or three days after the injury, soap liniment may be rubbed in.

Chilblains and Frostbites.

Chilblains are often due to tight boots compressing the toes and preventing circulation, thus rendering the surface of the skin liable to suffer from the effects of a low temperature; also, to warming the semi-frozen hands or feet at a fire before the circulation is restored. Whether on the feet or hands the parts affected should be well rubbed with snow, or with camphorated spirits, and, if the latter be not procurable, bathed in a strong solution of salt in water, afterwards thoroughly dried with a rough towel and protected by woollen coverings. Open chilblains should be poulticed till all inflammation is removed, then healed by the application of zinc ointment spread on lint. The more serious form, *frostbite*,

requires careful attention or mortification may set in. The part should be well rubbed with snow or pounded ice, and then wrapped in cloths wet with cold water. Be careful not to bring the frozen part near a fire.

Concussion of the Brain.

Result of a fall, or of a blow on the head. *Symptoms*:—Drowsiness, unconsciousness; the patient may be roused by shouting into the ear, but quickly relapses into insensibility; coldness of the surface, feeble pulse, breathing slow or laboured. *Treatment*:—Absolute rest; wrap up the body in warm blankets, and apply hot water bottles to the feet; do not attempt to give food or drink of any kind; be patient above all things, and avoid active measures. When symptoms of rallying appear, a calomel purgative may be given, and some liquid nourishment administered with caution.

Fractures and Dislocations.

The most common fractures are those of the collar-bone, (caused by a fall on the shoulder), of the ribs, and of the bones of the leg and arm. In all cases the indications for cure are comprised in endeavouring to maintain the broken parts of the bone in contact, and to prevent all motion in the affected part. This, in the case of the bones of the extremities, is usually attempted to be carried out by the employment of splints and bandages, which should be so fixed as not only to maintain the broken part in its normally straight position, but also to overcome by extension the constant tendency of the broken extremities to override one another owing to muscular action. Splints may be extemporised by cutting sufficiently long pieces of board into lengths of suitable size, or, in the absence of these, by tying together with twine, as in the figure below,

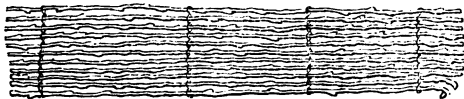

a sufficient number of small rods. In the same way rushes or iron wire may be made available, or the limb may be padded with cotton wool, then evenly and closely bandaged, and the bandage subsequently stiffened and converted into a circular splint by being well rubbed with boiled starch.

In fracture of the collar-bone a pad about 6 inches square by 3 inches thick should be placed in the arm-pit. the forearm should be raised and supported in a sling made by tying a large handkerchief round the neck, and the arm be securely fixed to the side of the chest by a belt or wide bandage. In fractures of the ribs a broad bandage should be made to encircle the chest tightly by several turns, fixed by sewing the folds together, and supported by shoulder-straps of tape. Fracture of the upper arm requires four narrow long splints, padded with some cotton wool, and retained in position by a long bandage carefully applied. The forearm should be supported in a sling from the neck, and the elbow be allowed to drop. In fractures of the forearm a pair of long and rather wide padded splints are sufficient, one extending from the elbow to the tips of the fingers behind, the other to the palm of the hand. Before placing them in position, the elbow should be bent and held firmly while the forearm is strongly pulled, the thumb being kept upwards. Fractures of the lower limbs are much more serious accidents, and require absolute rest. Those of the thigh can be efficiently treated by a surgeon only. In fracture of the leg, invariably keep the great toe in a line with the inner edge of the knee-cap; a pair of splints long enough to reach from the knee to the sole of the foot should be applied, one on the outer side, the other on the inner side of the limb. Excellent pads for the splints may be extemporised by folding a coarse linen cloth in four so as to reach from the knee to the heel, and wrapping it round the back and sides of the leg. Until a resting-place is arrived at, the broken leg should be securely tied to the sound one. Fractures in which the broken bone protrudes from a wound are very serious injuries. Having washed away all dirt by syringing the wound with carbolic lotion, place a piece of lint well soaked in carbolic oil over the protruding bone, so as to exclude all air, and then, by pulling carefully upon the opposite ends, endeavour to draw the protruded part inwards into position. The same methods recommended in simple fracture for applying splints may be used after reduction; but it will be necessary to leave the part opposite the wound uncovered by the bandage, so as to allow discharges to escape, the wound itself being protected from the air by a piece of lint soaked in carbolic oil.

Of *Dislocations*, space will not admit of referring to more than one, the commonest, namely, dislocation of the shoulder-joint. In this injury the head of the bone may be felt in the arm-pit, the elbow projects

outwards, the arm is lengthened, the shoulder appears flattened, and the patient cannot raise his hand to his head. *Treatment*:—Let the patient lie down on the floor; then, sitting on the floor in the opposite direction, the operator should place his unbooted foot in the patient's arm-pit, and with it press upwards and outwards, while he pulls the arm strongly and steadily towards him. In this way reduction is generally easily effected.

Rupture.

A protrusion of part of the intestines, generally beneath the skin of the groin or of the thigh. This may at first cause little inconvenience, but, if not soon returned into the abdomen, it may become constricted, causing constipation and pain, followed by continued vomiting of excrementitious matters, mortification of the bowels, and death. *Treatment*:—Raise the patient's hips with pillows till much higher than his head as he lies on his back, let him draw up his legs and thighs and have them supported by other pillows placed under the soles of the feet. If ice be procurable place small bags of it about the rupture. In this position the weight of the intestines acts upon the protruded gut while the walls of the abdomen are relaxed, and reduction of the rupture may take place spontaneously. If not soon relieved give thirty to forty drops of tincture of opium and allow the patient to remain so for an hour. Then gently knead the lump with the fingers and press it upwards, still careful not to use any force. Should these measures fail, the patient may be placed in a warm bath and another attempt made to push the intestine into the abdomen, which, if also unsuccessful, should be the last, for surgical aid must then be sought for at any cost.

Snake-bite and poisoned bites in general.

Travellers on foot, in places infested by snakes, should be careful to wear stout gaiters. Bites of venomous snakes may be generally recognised by the two circular punctures (thus ● ●) made by the fangs, the other minute teeth producing only slight scratches, if any. In the case of bites from sea-snakes (which are very poisonous), this distinction is scarcely apparent, owing to the small size of the fangs.

The treatment of snake-bite, as recommended by Sir J. Fayrer, M.D., F.R.S., is as follows:—"Apply at once a ligature, or ligatures, at intervals of a few inches, as tight as you can possibly tie them, and tighten the one

nearest to the wound by twisting it with a stick or other such agent. Scarify the wound and let it bleed freely. Apply either a hot iron or live coal, or explode some gunpowder on the part; or apply either carbolic acid or some mineral acid or caustic. Let the patient suck the wound whilst you are getting the cautery ready, or, if any one else will run the risk, let him do it.

“If the bite be on a toe or finger, especially if the snake have been recognised as a deadly one, either completely excise, or immediately amputate at the next joint. If the bite be on another part, where a ligature cannot be applied, or indeed if it be on the limbs above the toes or fingers, cut the part out at once completely.

“Let the patient be quiet. Do not fatigue him by exertion. Give eau-de-luce, or sal volatile, or carbonate of ammonia, or even better than these, hot spirits and water. There is no occasion to intoxicate the person, but give it freely and at frequent intervals.”

Bites from jackals are dangerous, being occasionally followed by hydrophobia; they should therefore be treated on the same principles as above recommended for snake-bite.

As a preventive against and remedy for attacks from ticks and other troublesome insects, strong coal-tar or carbolic soap should alone be used when bathing, the legs and other parts especially exposed being subsequently protected by inunction with carbolic oil (one part of carbolic acid to twenty of oil). Individuals newly arrived in countries where mosquitoes abound are very liable to their attacks, so that when travelling in places specially infested by them it may be necessary to smear all exposed parts of the body with this oil, or to use veils of mosquito net. In tropical America and Africa, minute ticks often cause intense itching, which may, however, be at once removed by rubbing in oil. After walking through long grass the body should be carefully examined for the larger ticks and for the jigger (*Pulex penetrans*), the latter usually lodging under the toe-nails; these should be carefully dislodged, and the parts rubbed well with carbolic oil. In certain districts in India, Ceylon, &c., leeches abound in the long grass, and attach themselves to the passer-by, and often, by creeping into the nostrils, cause much loss of blood. After travelling, therefore, in such places, the clothes and body should be carefully searched for such intruders. They are best dislodged by salt and water. Keating's insect-powder affords protection from fleas and bugs.

Sprains.

These most commonly take place in connection with the ankle joint. Absolute rest is required; the injured part should be raised on a pillow and kept immovable by placing one or more small bags filled with sand on either side. Warm fomentations are usually more soothing than cold, and, if there be much inflammation, apply leeches.

Ulcers,

Usually occur upon the legs or arms, and in the tropics often result from the irritation caused by parasitic animals. *Treatment*:—Apply cotton wool or lint soaked in carbolic oil, cover with a piece of oiled silk, and bandage carefully from below upwards; the limb should be kept elevated on cushions, and the dressings changed twice daily. In simple ulceration vaseline or zinc ointment applied on lint will generally quickly effect a cure.

Wounds.

Slight clean cut wounds are best treated by bringing the edges at once together, and securing them in that position by narrow strips of adhesive plaster. If large and there be much bleeding, the latter should be first controlled by raising the limb, by the application of ice, or by ligature (see above, under "Bleeding"), and all dirt, pieces of glass, &c., must be carefully removed before bringing the edges together. Lacerated and contused wounds may be caused by bites and gorings of wild animals, by machinery, or by gunshot injury. The wounded parts should be well washed out with tepid water, and then brought together by plaster or by stitches as far as possible. If there be much laceration and injury of the parts, poultices, to allay inflammation, should then be placed over the wound, and saline purgatives administered. However much injured the parts may be, the least shred of skin should be preserved. If poultices be not procurable, any kind of clean cotton or linen rags may be soaked in water and used instead. They should be covered with oiled silk and changed two or three times daily when suppuration takes place, the discharges being carefully washed away at each examination. In *scalp wounds* the hair should be carefully cut away, and the head shaved for some distance round the wound, the edges of which should, if possible be brought together by strips of adhesive plaster only.

Extemporaneous Transport for the Sick.

Cut two stout poles, each 8 feet long, to make its two sides, and three other cross-bars of 2½ feet each, to be lashed to them. Then, supporting this ladder-shaped framework over the sick man as he lies in his blanket, knot the blanket well to it, and so carry him off palanquin fashion. One cross-bar will be just behind his head, another in front of his feet, the middle one will cross his stomach and keep him from falling out, and there will remain two stout handles for the carriers to lay hold of. A kind of waggon-top can easily be made to it with bent boughs and one spare blanket (Galton). It may be added that, if possible, the sides of the blanket should be fastened with twine to the poles, and the bearers should *not* keep step.

3. CONTENTS OF TRAVELLER'S MEDICINE BOX.

(Sufficient for one person for a year.)

Box should be of strong lacquered tin, cylindrical, divided into upper and lower compartments by a cylindrical tray capable of being easily lifted out. In the lower, fixed in tin sockets, with well-fitting stoppers, tied down with wash-leather, the following fluid medicines (N.B. Poisons and irritants to be in blue fluted bottles), to be labelled thus:—

No. 1. Tincture of opium: sedative. Dose, 10 to 30 drops in water, not to be repeated for six hours. In diarrhœa, dysentery, pleurisy, colic, sleeplessness, &c. (for adults only).

No. 2. Paregoric elixir: sedative. Dose, 15 to 60 drops in water; for a child 2 drops. In colds, coughs, bronchitis.

No. 3. Chlorodyne (Collis-Browne's). Dose, 5 to 25 drops in water. In seasickness, diarrhœa, colic, cramps, spasms, neuralgia.

No. 4. Sal volatile: stimulant. Dose, 20 to 60 drops in water. In fainting-fits, nervous headache, low fevers, cholera, pneumonia.

The above to be in centre; the following, labelled "for external use only," round sides:—

No. 5. Liniment of opium. To be rubbed in with the hand. In sprains, bruises, local rheumatism, sciatica.

No. 6. Turpentine oil. For fomentations; to be sprinkled on flannels wrung out of boiling water and at once applied to the skin. In colic, dysentery, pleurisy, pneumonia.

No. 7. Blistering fluid. Applied with a feather quickly raises a blister.

No. 8. Carbolic acid. Used in solution only. 1 part to 100 parts water; to remove foul odours, to wash wounds with. 1 part to 20 parts olive or linseed oil; as an application to ulcers, to prevent attacks from insects, to destroy ticks, &c. (Be careful not to let the undiluted acid touch the fingers or any part of the skin. If this occur, at once apply oil.)

No. 9. Olive oil. For use with above; as a local application to burns, &c.

(N.B. One to two ounces of each of the above medicines will be sufficient, as they can be renewed as opportunity offers.)

In the upper compartment place the following, to be thus labelled:—

No. 10. Effervescent citro-tartrate of soda (4 ounces, in two stoppered bottles). Dose, one or two teaspoonsful in half a tumblerful of water on rising in the morning. For constipation, after calomel taken at bedtime, &c.

No. 11. Colocynth and hyoscyamus pills (3 dozen, sugar coated, in bottles). In constipation, one or two at bedtime, to be used only when No. 10 is not available or is ineffective.

No. 12. Opium pills (two dozen, 1 grain in each). Dose, 1 pill. In diarrhoea, rupture, spasms, colic, &c.

No. 13. Dover's powder ($\frac{1}{2}$ oz.). Dose, 5 to 10 grains (one to two capsules). In bronchitis, pleurisy, dysentery.

No. 14. James's fever powder ($\frac{1}{2}$ oz.) Dose, 5 grains (one capsule). In liver congestions, as an adjunct to calomel, in pleurisy, feverish colds, &c.

No. 15. Calomel ($\frac{1}{2}$ oz.). Dose, 5 to 8 grains (half to one capsule). In liver congestions, pleurisy, &c.

No. 16. Quinine (1 oz. to 1 lb. if space admit, for, if not required for the traveller's personal use, it will be gratefully received or purchased by others). Dose, 2 to 15 or 20 grains (half to four capsules). In malarial fevers, &c.

No. 17. Ipecacuanha powder (1 oz.). Dose, 5 to 15 grains (one to three capsules). In dysentery, especially in the premonitory or acute stage.

No. 18. Extract of hyoscyamus (1 oz.). Dose, 5 to 10 grains (one to two capsules). To be taken when calomel is administered, or, alone, to procure sleep.

N.B. Nos. 13–18 should be made up in gelatine capsules or lamels 5 grains each (as prepared by Messrs. Savory and Moore, 143, New Bond Street, W.) and kept in bottles or in well-closed small tin boxes. These preparations are much recommended to the traveller on account of their great portability (they may be carried between the leaves of a book), and also as it is impossible to make a mistake in the dose.

No. 19. Zinc ointment (4 oz.) To heal abraded surfaces, &c.

No. 20. Vaseline (4 oz.). For use as simple ointment.

No. 21. Morphia and bismuth snuff (see p. 258) ($\frac{1}{2}$ oz.). For colds in the head.

Also adhesive plaster (Leslie's tape plaster in tin); mustard leaves (Rigollot's,

one box); linseed leaves (Rigollot's, for poultices, one box); mustard, in tin, 4 oz.; oiled silk (in tin); nitrate of silver in holder; a small glass syringe; sulphate of zinc ($\frac{1}{4}$ oz.); alum (1 oz.); dressing forceps, scissors, surgical needles and ligature silk; a clinical thermometer in case; two long cotton bandages, and lint and cotton wool (which can be used as padding over all). The traveller should also carry in his general kit a large piece of *spongio-piline* (most useful for applying fomentations), and some soft soap in tin.

It is recommended that the following medical comforts (for use on emergency only), enclosed, except the five last, in tin cases of not more than 4 ozs. each, be also taken: arrowroot, 1 lb.; essence of beef (Liebig), 1 lb.; preserved milk, 1 lb.; cocoa and milk, 1 lb.; tea, compressed, 1 lb.; sugar, 1 lb.; salt, 2 ozs.; pepper, 1 oz.; brandy, 8 ozs. Of course the above quantities will be increased or diminished according to the length of the intended journey and the amount of space available.

For large parties, the Medical Field Companion Case, filled with proportionately larger quantities of the above-named medicines, &c., is recommended, as being lighter and more portable than a sufficiently large tin box. This may be procured at Messrs. Savory and Moore's, where both it and the Traveller's Medicine Box are kept ready for inspection, filled with the medicines and medical appliances recommended above.

VIII.

GENERAL HINTS ON OUTFIT.

*Including Notes by E. WHYMPER, COLONEL J. A. GRANT, C.B., and
J. THOMSON.*

SUGGESTIONS regarding a suitable outfit for a traveller must necessarily be of a most general character, as each traveller requires a special outfit according to the nature of his journey, its aims and duration, the number of persons composing the expedition, and the funds at command. An outfit which might be very complete and suitable for an Arctic journey or a very cold climate would obviously be unadapted for a journey in tropical countries, though it would contain some articles which might be useful in all regions. And even where the conditions may not be so wholly dissimilar as in the case mentioned, as in South America, Australia, and Central Africa, the traveller will in each country require many distinct articles, and find others superfluous. The case of a journey including much use of boats will, of course, demand its own specialties. Into these it has not been thought necessary to enter here. In this, and in all other cases where special information is needed, the intending traveller will do well to apply to the officials of the Society, who will, in most cases, be able to put him into communication with the best authorities of all, his last predecessors in the region he is about to visit. He may also obtain much useful general information from Mr. F. Galton's 'Art of Travel,' and Messrs. Lord and Baines's 'Shifts and Expedients of Camp Life.' For more detailed information as to particular branches of his Outfit, e.g., Scientific Instruments, Photographic Apparatus, Medicines, or the paraphernalia of a naturalist, he should also consult the previous chapters to which references are hereafter given.

It is not advisable to lay down any general rule as to whether the traveller should complete his outfit at home or abroad. There may be some occasions on which it may be best to complete abroad. But, inasmuch as far greater facilities of purchase and for packing are to be had at home, the reasons would have to be very weighty and exceptional which would render it desirable that this course should be adopted.

Travellers, again, in some regions require to carry much of their food with them, while in others they can obtain almost all necessary sustenance on the spot. In some countries there are considerable facilities for transport, and there is no need to reduce the baggage to very small dimensions; in others the difficulty of transport is amongst the greatest to be encountered. These various considerations must all be taken into account, and the leader of an exploring expedition will give proof of his fitness in showing, by judicious selection, that he appreciates the relative importance of particular articles.

In the arrangement and packing of the stores there are, again, considerable opportunities for the exercise of sound judgment.

On this subject some hints may be offered under four heads, viz.:—methodical arrangement, security, economy, and the catalogue.

1. *Methodical arrangement.*—Articles likely to be in most frequent use should be packed together, care being taken not to bring articles likely to injure one another into close contact. Fragile articles (such as glass bottles) should be packed in small separate boxes or cases, so that, should they be broken, they may not leave a void which will cause all the contents of their case to jumble about. Chemicals and explosives should be kept separate from other things; and, before being packed, inquiry should be made as to regulations to which they will have to submit on ship-board, &c.

2. *Security* against (a) breakage, (b) damp, and (c) robbery should be studied whilst packing.

a. To guard against breakage, packages should be of reasonable dimensions. For an inland traveller 75 lbs. gross weight should be about the maximum of any single package. A horse or mule can take a (conveniently shaped) box of this weight on each side, and 50 to 60 lbs. between them on the top. Where goods are intended to be carried by porters, it is not recommended that any single package should weigh more than 56 lbs. Heavier packages will almost certainly have to submit to very rough treatment. Further security against breakage can be had by sub-division, that is to say, by packing boxes inside boxes, tins within tins, &c. Everything should be *tightly* packed, and all vacant spaces filled up. Oblong boxes travel best. The air-tight metal, so-called "uniform," cases, are strongly recommended, but for a prolonged journey require to be protected by outer wooden cases.

b. To guard against damp (on ship-board, in countries with heavy rains, passage of rivers, &c.), all perishable things should, where practicable, be enclosed in tin and soldered, *particular care being taken that everything is thoroughly dry before being soldered up*. It pays the traveller well to have his outer wooden cases made of the best deal, closely fitted, and varnished or double varnished to prevent absorption of moisture by the wood.

c. Closely-fitted, well-made cases afford great trouble to thieves, and gaping packages, with partly-exposed contents, invite robbery. Boxes which are *screwed* down are more secure than nailed boxes, as thieves are frequently not provided with screwdrivers. Use *brass* screws, if possible, for cases which have to be frequently opened and re-opened; iron screws, if used, should be tallowed before insertion; they will then unscrew more easily. Articles of value should be kept out of sight as much as possible.

3. *Economy*.—It is false economy for the traveller to buy any but the best articles for his outfit, or to carry useless things. Many articles may be put to double uses, and economy can be effected by selecting such materials as can be most widely applied. For example, articles to be used as presents may also be put to use on the journey. There should be no waste space in the packages. Every interstice can be filled up with articles which may be turned to account. For the finishing touches tow, cotton-wool and paper may be advantageously employed, as all these materials can be used for a diversity of purposes. If the traveller does not himself superintend the packing of his goods, he must not expect foresight in these small but important particulars.

4. *The Catalogue of Outfit*.—As each package is finished its contents should be carefully catalogued, and the package numbered distinctly on several sides, corresponding numbers to be entered in the catalogue. In the event of the contents of a box being varied and numerous, roughly classify them before entering. The traveller himself should carry the catalogue on his person, and, where there are a large number of packages and articles, it will be found of advantage to form a classified catalogue showing the disposition of the articles, as well as a numerical one showing the contents of each package.

The articles which go to make up a more or less complete outfit may be roughly classified under the following heads:—1, Provisions; 2, Clothing; 3, Instruments; 4, Stationery, note-books, books and maps; 5, Appli-

ances for collecting; 6, Articles for presents or barter; 7, Camp equipments; and 8, Medicines.

1. *Provisions*.—The following are good for all countries and all climates:—tea (in tins); preserved milk, or cocoa and milk (in tins); Liebig's extract (sold usually in jars, but will keep equally in well-soldered tins); preserved soups in tins (Symington's pea-flour soup is excellent at low temperatures, and requires only one minute's boiling); lemonade effervescing powder (will keep perfectly if soldered in tin); dried onions; eating-raisins; chocolate in cakes; mustard, salt, pepper, and curry-powder.

Preserved meats of all descriptions can now be procured in nearly all civilised parts, and in most instances will keep for an almost unlimited length of time. When purchasing, all tins should be inspected, and *bulged or battered ones should be rejected*. A convex end indicates putrefaction inside. The best course is to purchase direct from makers of established reputations. Empty provision-tins are often highly appreciated as presents, and the larger can be utilised also for natural history specimens (birds and mammals); the smaller for shells, insects, &c.

2. *Clothing*.—Woollen goods are to be preferred for all countries and for all climates. Boots should be amply provided, and be got into wear before departure; they should be broad-soled, and not too thick or heavy. A supply of nails should be taken. An "ulster" coat, one or two sizes larger than a fit, will be found useful to sleep in. Travellers who have been in, or near, the districts to be visited, should be consulted as to what specialties may be required.

3. *Instruments (including Photographic Apparatus)*.—(See Sections I. and VII.)

4. *Stationery; Note-books; Books and Maps*.—The descriptions of paper most useful are bank-post, tissue, and botanical. Note-books should be made out of bank-post, be bound in parchment, and have gilt edges. It will be found a great convenience, to classify observations into separate books, or distinct divisions: (*a*) an angle-book, for the survey observations, barometric, &c.; (*b*) a general note-book; (*c*) notes on and numbers of natural history specimens. Such classification must be effected sooner or later if the observations are to be turned to account. Tracing-linen (sometimes called tracing-cloth) is more useful than tracing-paper. Labels, adhesive or tied, according to the climate, for bottles with

natural history specimens, should not be forgotten. Ink-powders, a good portable inkstand, and steel pens of various descriptions should be taken. Brandauer's "Oriental Pens" are recommended for fine work. Sketches and notes, particularly the records of angles, in pen-and-ink are to be preferred to the same in pencil, as the latter often become illegible.

The nature and the extent to which the traveller should take books and maps must be determined by his particular circumstances. A few sheets of Letts's sectional paper (*i.e.* paper with printed lines crossing at right angles) will always be found of service for making maps and plans.

5. *Appliances for Collecting.*—(See Section IV.)

6. *Presents and Articles for Barter.*—Clasp-knives, of all sorts, are esteemed. These are most advantageously obtained direct from Sheffield and Birmingham manufacturers of repute. Spectacles are useful in many countries. Small musical-boxes are generally appreciated. Beads are still good for many parts, but judgment is required in purchasing only those sorts that are in fashion. Information should be sought from previous travellers. Birmingham and Venice are the principal centres of the bead manufacture. For almost all wild or partly-civilised countries special articles may be usefully carried. Inquire beforehand.

A few simple conjuring tricks, and the knowledge of how to show them off, are often of the highest use to travellers in winning the esteem and respect of their temporary hosts.

7. *Camp Equipments; Filters; Arms.*—For rough travelling, or for journeys on which it is desirable to carry only a moderate amount of impedimenta, the pattern of Whymper's Alpine tent is recommended. Tents of this nature, 7 × 7 × 7 feet, form a moderate load for one man. For prolonged journeys it is best not to have the mackintosh floor sewn down, but loose, so that it may be readily dried. Several waterproof sheets of various sizes are sure to come in handy. Tents (small *Pal*), 7 × 7 feet, poles 5½ feet, were used in the Kashmir Survey in the high ground, made of cotton cloth (*dussootie*), and lined with coarse woollen cloth (*puttoo*), made in the country. With their light fir poles they were only a load for one man. The men often preferred lying in them on the ground to pitching them.

Filter.—A good "traveller's filter" is still a desideratum. Abyssinian pocket-filters are recommended, but are of no use for the supply of large quantities. A piece of mackintosh sewn up in a cone shape, with cane or wire round the large end to distend it, and with a piece of sponge fitted

in the neck, is better than nothing. Not only filter thoroughly, but also boil the water. Too much trouble cannot be taken to obtain pure water. More travellers have probably lost their lives through fever, and through drinking bad water, than from all other causes put together. For carrying water for use on the march (or other liquids), Silver's ebonite flasks, felt-covered, with attached straps, are recommended.

Some knowledge of how to cut up an animal or prepare a fowl for the pot is very useful. And the more the traveller knows of simple cookery the better, for if he should not cook himself he will be in a position to teach others. He should, whether he will use it himself or not, take pains to select before starting the form of portable cooking apparatus best suited to his purpose.

A supply of fish-hooks and lines of different sizes are very useful; given out to the men in camp, they will often enable them to supply themselves with food.

Take strong riding-whips, and strong twine and whipcord. The best twine commonly made is called "page-cord" (used by compositors for tying up pages of type). If rope is wanted, use Manilla.

A small leather roll, containing a chisel and gouge or two, two files, one Δ gimlet, bradawls, small metal punches and cold chisel, wire-nippers, pincers, screwdrivers, and small fine saw, most serviceable for mending broken articles, if the travellers can use them.

Arms and Ammunition.—The nature and extent of his battery will be matters for the traveller himself to decide. For rough travel it is a question whether the muzzle-loading guns may not be better than breach-loaders. Revolvers are more useful for the moral effect they produce than from any actual service they render.

8. *Medicines.*—(See Section VII.)

The experience of their predecessors will probably be given to intending travellers in the most practical form, by furnishing them with the actual list of articles taken by some recent explorers. It has therefore been thought best to supplement these general remarks by complete lists of the outfits taken by Mr. E. Whymper on his recent journey in South America, and by Colonel Grant in Africa, to which are appended some notes by Mr. J. Thomson, now travelling in the Society's service in Equatorial Africa.

In introducing these lists it seems desirable again to point out that

they are given here as sources of valuable information, and not as examples for servile imitation. They are obviously open to diverse criticism. On the one hand, the preliminary list of Requisites, compiled chiefly from the catalogues of some of our principal outfitters, makes no pretence to be in any way complete. On the other, some of the articles in the lists which follow may become superseded by improved appliances and new inventions, or may be superfluous for travellers who have not the same means or aims as those who have supplied the lists.

If these lists appear at first sight excessively bulky and costly, the traveller must remember that they represent what practical and experienced travellers with scientific aims have actually found useful in protracted journeys—the one in a semi-civilised, the other in a barbarous country. He need not be discouraged if unable to imitate such completeness, for some of the greatest journeys have been made with very inadequate resources.

The object of the work is to give the traveller the means of selection. In the details of the process he must, as has been said before, guide himself by the special circumstances of his journey.

The traveller, whose object is to be in light marching order, can hardly be further instructed with profit than by a general admonition to see that he has suitable warm clothing, proper medicines, a serviceable cooking apparatus, which need weigh little more than a kettle, and concentrated forms of food to fall back on in case of need.

Requisites for a Tropical Tour—

Leech gaiters; * ventilated topee; puggarees; felt hat; stout shooting-boots; canvas shoes; rug or plaid; mosquito curtains; waterproof tin despatch-box; lined umbrella, for sun; † bags, saddle, and

* Colonel Godwin-Austen says: "An effective way to prevent leeches attacking the ankles and legs, is to wear woollen stockings; then over them, round the legs, *patawas*, the woollen bandages as worn in the Kashmir Himalaya, and now served out to our troops on mountain service in India. Then, last, a pair of cotton socks tied above with tape. After adopting this plan in the Terai and Assam I never got bitten." Stout cloth gaiters with straps, *not* buttons, are preferred by many travellers to leather. They are lighter, warmer, and resist snow better.

† For surveying work should have a long handle, in two pieces or joints, the lower joint being spiked to fix more firmly in the ground.

valise; field hammock; portable camp bedstead; folding tables; hunting-knives; patent ebonite water-bottle, covered in felt.

Requisites for an Arctic Tour—

Flannel shirts; under waistcoats and drawers; long lamb's-wool stockings; woollen suit; fur coat, gloves and cap; flannel or blanket belt; woollen comforters; snow shoes; mocassins; hair eye-screens; wool, Austrian, or fur rugs.

Patent Norwegian cooking apparatus; wood camp bedstead, with sacking bottom; bed for ground; black canvas valise, with serge cork mattress; sleeping-bags of woollen material or sheepskin straps; tent-pole hook; canteens, fitted with enamelled iron ware waterproof bags; tan canvas kit.

LIST OF MR. WHYMPER'S SOUTH AMERICAN OUTFIT.

Stationery, &c.—

Stencil-ink, brushes, and stencil-plates (various).

2 "Traveller's Inkstands" (Hachette's); inkstand in case.

Steel pens (various), including very fine sorts; stylographic pen.

Drawing pencils, brushes, pen-holders, and letter fasteners.

Parchment and gummed labels (various), 6 gross in all.

Tissue paper (useful for various purposes, including photographic printing).

Bank-post; cream-laid papers (various sizes); blotting-paper.

Stamped and plain envelopes (various); canvas envelopes.

4 doz. memorandum books; sketch-books; gum; ox-gall; red tape.

Tracing-paper, and a roll of tracing-linen; ferro-prussiate paper.

Drawing-pins; penknives; Chinese white and water-colours; 2-foot steel rule.

Note-books, bound in parchment, with clasps; photographic register; journal and general note-books; daily notes; angle-book; boiling-point book; catalogue of collections.

Maps, Books, &c.—

Admiralty charts, maps, and works of importance, for reference on the spot.

Dictionaries and grammars for languages spoken in country to be traversed.

'Hints to Travellers.'
 Lockyer's 'Astronomy.'
 Bethune's 'Tables.'
 'Admiralty Manual.'
 'Sailor's Pocket-Book.'
 Frome's 'Surveying.'

Photography.—

12 doz. prepared dry plates ($8\frac{1}{2} \times 6\frac{1}{2}$ inches).
 8 " " " ($6\frac{1}{2} \times 4\frac{1}{2}$ ").
 Nest of glass measures; stirring-rods.
 Beakers, from 25 oz. downwards.
 Water-tank with tap, india-rubber tube and clip.
 6 printing frames.
 Draining-rack for plates.
 Scales with glass pans, and weights down to half a grain.
 100 pieces albumenised paper soldered down in zinc.
 200 " sensitised " " "
 5 ebonite trays for developing.
 1 glass dish " "
 Large flat camel's-hair brush.
 Whole plate camera (Meagher's), in leather case, with five double
 backs and one single ditto; two folding camera-stands (long and
 moderate length).
 Doublet lens (Ross).
 Symmetrical lens (Ross).
 12 lbs. hyposulphite of soda, soldered up in small packages.
 3 ozs. pyrogallie acid, soldered up in separate ounces.
 8 " bromide of potassium (used also medicinally).
 4 " acetate of soda.
 12 tubes chloride of gold.
 Ammonia, in glass-stoppered bottles, soldered in tin cases. }
 Parcel of filtering-paper. }
 Ruby glass lamp.
 " " in strips.
 6 negative store-boxes, to hold 24 plates each.

Clothing, &c.—

9 towels; 12 flannel shirts; 2 white shirts; 16 pairs angola socks; 26 pocket-handkerchiefs; 3 neckties; 6 shirt-collars; 3 pairs mountain-boots; 1 pair ordinary boots; 1 pair lawn-tennis shoes for shipboard; 4 suits, woollen, various thicknesses; dress suit; Panama straw-hat; Arctic cap; travelling-cap.

Red felt for tablecloth; large sponge and several small pieces; tooth-brushes; very thick woollen jersey; 2 rowing "sweaters;" 2 woollen comforters; 2 neck-wraps; 3 pairs knitted woollen gloves; 1 pair woollen mitts; 2 pairs leather gaiters (own pattern); 2 linen masks (for snow); 2 woollen head-pieces; folding felt slippers; cork soles; small pieces of mackintosh (various); several hanks whitey-brown thread; several pieces inch-wide tape; dusters and cloths; common pins, sewing-needles, and packing-needles; down dressing-gown; very long ulster coat.

Miscellaneous.—

Two tents (own pattern) 7 × 7 × 7 feet, packed in stout canvas bags. Sheepskin rugs laid down on felt.

Waterproof sheet 10 × 10 feet.

 " " 6·6 × 6·6 feet.

4 bags of forfar (to be stuffed with hay for beds).

4 " " (" " " pillows).

Various bags (to be filled with stones or sand to keep the tents firm).

Four 100-foot lengths of Manilla rope; 6 ice-axes.

Various mackintosh and leather courier-bags and knapsacks.

Musquito-nets; various bags of forfar; tin flasks and cans.

2 pint ebonite bottles, felt-covered, with straps (Silver's).

Cooking apparatus (from Nares' surplus stores), with attached pannikins, and small ditto.

Water-tank, with filtering sponge and tap; 2 pocket filters.

Salter's spring balance, weighing to 25 lbs.

Double gun, by Holland (rifle and shot), shot (various), gun-powder, &c.

Night-lights and candles; folding camp-chair.

Insect-net; botanical collecting-book and paper.

Knives for opening tins; brass spirit-lamp.

Geological hammer.

14 lbs. tobacco; cigars, cases, pouches, pipes; flint and steel.

14 cakes soap; camphor.

Balls of strong twine (various); screws and nails, various sizes.

3 gross glass bottles (various sizes) for insect collecting.

Medicines (various).

Presents, &c.—

500 bead necklaces (amber, turquoise, &c.).

250 silvered and gilt crosses, various patterns.

150 pairs of earrings and brooches.

300 eye-protectors (green, blue, white, and neutral tint glasses).

72 gilt and silvered watch-chains.

24 pairs of spectacles and eye-glasses.

18 tin dishes fitting one inside another

25 „ plates

36 „ spoons

} (used also in cookery).

Silver toothpicks.

Keyless silver watch.

25 good pocket-knives, various descriptions.

6 corkscrews.

Small tape measures in brass cases.

Various plated goods.

12 circular looking-glasses.

12 mouse-traps.

Instruments.—

Silver lever watch; gold pocket-chronometer; independent seconds watch.

Repeating travelling clock, with alarum.

6-in. sextant (Cary).

3-in. transit-theodolite (Casella).

2 theodolite stands

„

2 mountain mercurial barometers, Fortin (Hicks).

1 mercurial standard barometer.

11 boiling-point thermometers (various makers).
 Henderson's boiling-water apparatus (Hicks).
 8 aneroid barometers (Hicks, Casella, Hilger).
 Telescope in sling case; field-glass in aluminium.
 Thermometer in metal tube, for pocket.
 Case containing maximum, minimum, and clinical thermometer.
 Prismatic compass; various pocket-compasses.
 Multiplying winch and measuring line.
 Metallic measuring tape, 50 feet (Chesterman's).
 Case of mathematical instruments.
 Drawing-pens (various); Napier's compasses.
 Travelling combination pocket-knife; corkscrew and whistle.
 Russian furnace.
 Magnesium riband.
 Small musical-box.
 Screwdrivers (various).

Clothing, instruments, and valuables were packed in air-tight metal uniform-cases, with outer double-varnished wooden cases. Provisions and the bulk of the goods were packed in tin, and soldered down, inside double-varnished close-fitting wooden cases. Chemicals and articles likely to be injured by damp were in double tin cases, soldered down separately one over the other. The majority of the cases measured $28\frac{1}{2} \times 11\frac{1}{2} \times 10\frac{1}{2}$ inches. This was found a very convenient shape for mule travelling.

The whole, including provisions, amounted to 42 packages. Gross weight about 2300 lbs. Total cost of journey 1750*l.*, exclusive of cost of instruments and plant brought home in good condition.

All of the articles enumerated in the above lists were taken out from England, and scarcely anything, except part of our food, was purchased in Ecuador beyond the following articles:—

Waterproof capes (ponchos); woollen ponchos; saddles; riding-whips; machetas.

These articles could have been obtained of better quality and at less cost in England.

ED. WHYMPER.

February, 1883.

LIST OF THE LATE CAPTAIN SPEKE'S OUTFIT.

The following articles constitute the kit taken by Captains Speke and Grant in their journey, 1860-63, from Zanzibar to Egypt. Colonel Grant says it was found sufficient for both of them for three years, though not replenished, except with some copper wire, beads, and cowries bought in the interior.

Instruments for observing—weight, 228 lbs.

- 3 sextants, 8½ inch radius; one left in Africa.
- 2 stands for ditto.
- 2 artificial horizons, and bottleful of mercury.
- 1 gold chronometer; 1 silver ditto: 1 lever watch, with double detaching second hands; 1 lever watch with split second hand; 1 ordinary watch.
- 3 prismatic compasses, cardless, with platinum rings.
- 2 magnetic compasses.
- 1 telescope in sling.
- 1 Traveller's and 1 Livingstone's rain-gauge.
- 6 boiling thermometers, 1 maximum and 1 minimum.
- 2 bull's-eye lanterns, with vessels to fit, for boiling thermometers.

Mapping and Drawing Instruments :—

- 2 reams mapping paper; tracing paper.
- 1 circular protractor; 1 parallel ruler on rollers.
- 1 case mathematical instruments.
- 1 fifty-feet measuring-tape.
- ½ ream open foolscap, graduated in squares.
- 2 boxes (tin) of water-colours, in leather covers.
- 4 block sketch-books; brushes, and drawing-board.
- 6 dozen lead pencils (various).
- 2 gold pens, with which all writing was done.
- India-rubber and rings; set squares and curves.

Books :—

- Raper's 'Navigation.'
- Coleman's 'Nautical and Lunar Tables.'
- 4 log-books; 12 field-books; 5 longitude ditto.

*

U

4 'Nautical Almanacks,' 1860-63.
 Tables for measuring breadth of rivers.
 Maps of Africa, foreign and English.

Rifles, Arms and Ammunition.—Presents:—

2 single Lancaster elliptical rifles (bore, 40).
 1 single rifle (bore, 4).
 1 ditto (bore, 16).
 1 double rifle (bore, 20).
 1 double rifle (bore, 10)—present.
 2 smooth bores (bore, 12)—presents.
 1 Whitworth sporting rifle, single barrel (present).
 1 Colt's revolving rifle (present).
 2 Tranter's revolvers, in belts (presents).
 Turnscrews, vices, &c. ; no gun-cases, merely waterproof covers.
 500 rounds of ammunition for every barrel, and a few bags of shot ;
 powder and caps.
 50 carbines, with pouches, sword-bayonets, and belts (Royal Artillery
 pattern, 1860), each 18 lbs.
 200 rounds for each carbine ; caps in proportion.

Presents for Arabs:—

1 gold watch in a sword-belt.
 3 gold enamelled lever watches.

Bartering-Goods and Presents for Natives : purchased at Zanzibar:—

Copper and brass wire, value 4*l*.
 346 lbs. of copper wire.
 360 lbs. of brass wire.
 Cotton and silk stuffs ; 79 loads of 60 lbs. each.
 Total value of cotton and silk stuffs, 339*l*.
 Bead coinage, 36 loads.
 Total value of beads, 217*l*.

Camp Outfit:—

Two tents, single canvas, 7 × 7 × 7 feet—weight of both, 31 lbs. ; two
 poles each, their weight extra.
 12 blankets (grey Crimean), and 2 pair scarlet ditto ; weight 73 lbs.

- 2 white serge sheets.
- 2 iron bedsteads, 28 lbs. each.
- 2 iron camp-stools, 8 lbs. each.
- 2 musquito curtains.
- 6 sheets of white waterproof, about 10 feet square; used for rolling the bedding in, and for covering the roofs of huts or tents during rain.
- 2 hair pillows.
- 2 gingham umbrellas, half-carriage size with white covers.

Clothing:—

- 24 flannel shirts; 12 flannel trousers; 8 trousers of unbleached drill; 4 waistcoats of Scotch tweed, 4 deep pockets in each; 1 suit of blue serge; 1 alpaca coat; 24 pocket-handkerchiefs; 6 pairs leggings, of leather; 12 pairs of shoes; 6 dozen socks, half wool; 4 wideawakes; 1 housewife (large), needles, buttons, &c.
- 6 Japanned tin trunks:— $19\frac{1}{2} \times 13\frac{1}{2} \times 12\frac{1}{2}$; $21\frac{1}{2} \times 15\frac{1}{2} \times 14\frac{1}{2}$; $23\frac{1}{2} \times 17\frac{1}{2} \times 16\frac{1}{2}$, weighing 13, 14, and 17 lbs. each.

Cooking:—

- Nest of 7 double-tin buckets, each with its cover, which answered for plates, and black canvas cover; weight, 26 lbs.
- 1 digester for making soups, 15 lbs.
- 2 pewter mugs, without glass; 2 teapots (oval), tin.
- 8 table-knives; 4 table-spoons; 2 teaspoons.
- 18 lbs. of clarified butter.
- 9 bags of rice; 40 lbs. of tea; 108 lbs. of coffee.

Odds and Ends:—

- 4 leather bags.
- 2 saddles (Zanzibar), pack.
- 2 English stirrup-leathers, and 2 donkey bridles.
- 12 packets ink-powder (black and red).
- 9 lbs. white bar soap.
- 24 Rogers' 3-bladed penknives for skinning specimens.
- 6 sailors' knives, to hang from a cord.
- Botanical paper, thick and thin; 4 books for notes.

Photographic (stereoscopic) instruments and chemicals, dry plates, &c.
2-foot rule; spring balance to 60 lbs.; lamp-oil (6 bottles).

12 needles for repair of tents, &c.

Tools: 2 hammers, 2 saws, pincers, 6 files, 2 chisels.

Medicines:—

In brass-bound case, $8\frac{1}{2} \times 11\frac{1}{2} \times 10$, in an outer case bound with iron.

Weight, when full, 30 lbs.

*Contents:—*Brown's blistering tissue; calomel; plaster; citric acid; quinine, 6 ounces; essence of ginger; jalap; rhubarb; blue pill; colocynth; Dover's powders; laudanum; caustic; emetic. Also weights, scales, salves, pestle and mortar, &c.

Rum and brandy, about 20 bottles.

Instruments for observing, maps, books, arms, and ammunition ought of course to be taken from this country. If natives are the means of carriage the fewer boxes the better; strong bags, such as every sailor has, when soaked in a solution to resist damp and white ants, may replace them with advantage, and are carried with comfort to the men. A collapsing boat, such as is employed in our navy in the present day, is light, and answers well for crossing rivers. Boats of steel in sections, such as Stanley used in circumnavigating lakes, would be still better. Specimens of natural history, all papers, and botanical specimens must be protected in Japanned tin cases.

If I were to travel again in the interior of Africa, I do not think I would alter the above list except to add table-salt, pepper, pressed vegetables, curry-powder, rum or whisky, some pounds of tobacco, and a more ample supply of quinine, and twenty pounds weight of the seeds of our vegetables.*

J. A. GRANT.

22nd February, 1883.

* The cost of the journey came to about 3400*l*. The following were the principal items:

	£	s.	d.
Instruments for observing, supplied by R. G. S.	180	0	0
Mapping and drawing instruments	19	0	0
Books	6	7	0

MR. J. THOMSON'S NOTES.

The nature of the country I propose to traverse is an elevated table-land along the Equator, with numerous very high mountains, reaching to, and even rising above, the snow-line. It is expected that the expedition will last about a year and a half, and the means of transport is portorage by negroes, who carry their loads always upon their heads and shoulders, never upon their backs. The expense is estimated at 2500*l.* to 3000*l.*, exclusive of journey to Zanzibar and back, and the purchase of arms and scientific instruments. A large portion of the cost is incurred in the food and wages of the porters and escort; in this case, 150 men.

Bearing these facts in my mind I have provided the following outfit:—For carrying my clothes, books, &c., 8 boxes, of different sizes, water-tight, *well rounded* at the edges, not more than 10 inches deep, and not very wide, so that they may be easily grasped when on the shoulder or head. The larger boxes are for carrying clothes only, the smaller for a mixture of clothes with heavier articles, such as books, boots, &c. None of the boxes when filled to weigh over 50 lbs.

For clothing I have provided 1 ordinary suit of tweed clothes for the colder regions, 3 suits of tropical tweeds, and as many of white drill;

	£	s.	d.
Rifles—presents (carbines supplied by Government)	600	0	0
Presents to Arabs	115	0	0
Bartering goods and presents (purchased at Zanzibar for natives)	2064	11	0
Camp outfit.	50	0	0
Clothing	80	0	0
Cooking	25	0	0
Odds and ends	66	11	0
Medicines	12	5	0
Goods purchased in the interior—Expense of sending our followers from Cairo to Zanzibar—Their wages—Our journey from Cairo to England	210	0	0
	<u>3428</u>	<u>14</u>	<u>0</u>

6 strong loose shirts, with pockets, and as many thin jerseys; 6 pairs of thick *woollen* stockings or socks; 1 pair of strong boots, for wet season; 2 pairs of lighter make, for the dry season, and 2 pairs of canvas shoes for camp use, and when feet are sore. Heavy boots are to be condemned for the tropics, as the feet soon become scalding hot, making travelling in the heat of the day most painful.

Canvas gaiters are of great use, to keep mud out of the boots when tramping through swamps, and to protect the legs in thorny scrub. A tropical waterproof and a comfortable ulster make up the clothing list, with the addition of such minor articles as handkerchiefs, scarves, &c.

We have next to consider camping requirements.

I have formed a very decided opinion as to the necessity of the African traveller making himself as comfortable in camp as the *circumstances* and the *extent* of the expedition will permit. The climate is so trying and varied, that to attempt "to rough it" unnecessarily is simply to invite disease, and too often death.

Impressed by experience with these convictions, I have been careful to select a fairly roomy tent, 9 feet long, of good canvas. An iron bedstead, with cork bed, and two warm Austrian blankets. A folding chair, campstool, and small portable table. The latter is an immense convenience when much writing has to be done.

For short quick trips, in which I might be away from camp for a day or two, I have provided a palkee hammock, which forms a bed and tent in one.

For carrying any sick person an ordinary string hammock is taken. A mosquito curtain makes up the list of tent furniture.

Instead of carrying an ordinary bucket canteen, I have had a basket fitted up with all the necessary articles.

I, of course, take with me a small medicine-case, specially fitted with a view to the treatment of fevers, diarrhoea, dysentery, liver disease, &c., and besides I have been careful to have some of the more useful medicines in separate bottles in case of accidents.

Among other useful articles, the following may be mentioned:—Waterproof ground sheets; roll-up case of tools; one .577 Express rifle, one .577 reduced to .450, a 1.2 bore gun, a revolver, with ammunition to suit; two axes; a hunting knife; two bill-hooks and two reaping-hooks,

to be used in camping and cutting a way through jungle and forest; diary and necessary stationery; some books, especially such as can be read and re-read.

These articles, with scientific instruments, photographic apparatus, &c., form the chief part of my equipment.

I have not thought it necessary to lay in a supply of stores, such as tea, coffee, sugar, &c., as they can be got almost as cheaply in Zanzibar. Goods for bartering must also be got there, as I should otherwise run the risk of taking out what would, to a large extent, prove to be utterly worthless.

As the country through which I have to pass is reported to be dangerous, I shall arm as many of my men as possible with short Snider rifles, and take revolvers for myself and the leaders.

JOSEPH THOMSON.

December 3, 1882.

For further information on *Outfit*, especially in arid countries, the intending traveller is referred to pp. 9-11 of Mr. Galton's 'Art of Travel' (5th Edition).

MOUNTAIN TRAVEL.

The Highlands of Central Asia form one of the fields likely next to attract explorers. If their exploration is to be thorough, travellers must take with them some knowledge of glacial phenomena, and at any rate the rudiments of the mountain craft which has been brought to perfection by three generations of Alpine peasants. Without these qualifications they will find themselves obliged to leave large and, to the physical geographer and geologist, singularly interesting tracts of country unmapped and imperfectly explored. The practised mountaineer is free both from the fear and the rashness of the less experienced traveller. He is not likely to be deterred from visiting a remote valley because ice and snow, and possibly steep and rocky ridges, intervene between him and it; on the other hand he will not start on such an enterprise without every appliance that may enable him to conquer the difficulties of the way; he will not either be frightened into retreat by the first crevasse, or stopped by a hard-frozen slope.

Ropes and ice-axes (preferably of the Alpine Club pattern) are essential, and their proper use, up to the present time hardly known outside Europe, should be learnt. This may best be done in an Alpine tour, with an experienced glacier guide. A party of three is the smallest consistent with safety above the snow-line; and the majority, whatever the number, in any expedition of difficulty, must be experienced climbers. Such expeditions will best be made from a base where the heavier luggage and attendants are left.

The effect of rarified air at great heights in reducing the powers of the human frame is a subject on which precise knowledge is still wanting. No one has yet reached, or closely approached, the limit at which the exertion of walking uphill becomes impossible to a person in normal health and accustomed to great elevations. It lies therefore considerably above 22,000 feet. On the other hand, mountaineers agree that their powers diminish perceptibly as they ascend above 12,000 feet. In De Saussure's generation both he and his guides were, at 15,000 feet, on Mont Blanc, unable to do more than advance a few yards at a time, while modern climbers feel little or no inconvenience under the same external conditions. There is no doubt that the body acclimatizes itself to the upper air: and "training" is therefore the best remedy against mountain-sickness. Chlorate of potash lozenges may be used with advantage as a palliative.

The special requisites for snow and ice expeditions are included in Mr. Whympers's List.

General information on all subjects, both scientific and practical, connected with mountaineering is given in a compact form by Mr. John Ball in his Introduction to 'The Alpine Guide,' published separately by Messrs. Longmans (2s. 6d.), or, of more recent date, in the "Introductory Sections" to Murray's 'Switzerland' (Edition 1879). Mr. Galton has reprinted ('Art of Travel,' p. 49) the Alpine Club report on ropes and ice-axes.—DOUGLAS W. FRESHFIELD.

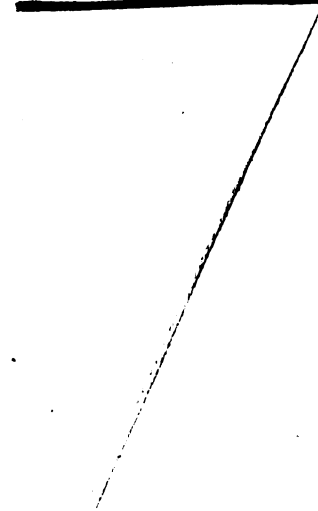

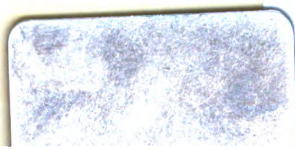

600038831T



